







Camera Product Comparison - ARRI Camera Models - part I



Configuration Overview | 1.0.0 / 2025.07







Model / Weight	Sensor Type	Sensor Size	Dynamic Range	Frame Rate	Codecs
 ALEXA 35 Xtreme Premium Model 3 kg / 6,6 lbs (1)	Super 35 format ARRI ALEV 4 CMOS sensor with Bayer pattern color filter array	4608 x 3164 27.99 x 19.22 mm 1.102x 0.757" Ø 33.96 mm / 1.337"	17 stops * EI 160 to EI 6400 EI 2560 ES to EI 6400 ES 11 stops ** EI 800 to EI 6400	0,75 - 660 fps * ARRIRAW, ARRICORE, ProRes ** ARRICORE / Sensor Overdrive	MXF/ARRIRAW MXF/Apple ProRes 4444 MXF/Apple ProRes 4444 XQ MXF/Apple ProRes 422 HQ MXF/ARRICORE
 ALEXA 35 Xtreme Base Model 3 kg / 6,6 lbs (1)	Super 35 format ARRI ALEV 4 CMOS sensor with Bayer pattern color filter array	4608 x 3164 27.99 x 19.22 mm 1.102x 0.757" Ø 33.96 mm / 1.337"	17 stops EI 160 to EI 6400 EI 2560 ES to EI 6400 ES	0,75 - 60 fps	MXF/ARRICORE MXF/Apple ProRes 4444 MXF/Apple ProRes 4444 XQ MXF/Apple ProRes 422 HQ
 ALEXA 35 Live 2,9 kg / 6,4 lbs (1)	Super 35 format ARRI ALEV 4 CMOS sensor with Bayer pattern color filter array	4608 x 3164 27.99 x 19.22 mm 1.102x 0.757" Ø 33.96 mm / 1.337"	17 stops EI 160 to EI 6400 EI 2560 ES to EI 6400 ES	0,75 - 60 fps	MXF/Apple ProRes 4444 MXF/Apple ProRes 4444 XQ MXF/Apple ProRes 422 HQ
 ALEXA Mini LF 2,6 kg / 5,7 lbs (2)	Large Format ARRI ALEV 3 (A2X) CMOS sensor with Bayer pattern color filter array	4448 x 3096 36.70 x 25.54 mm 1.444 x 1.005" Ø 44.71 mm / 1.760"	14+ stops EI 160 to EI 3200	0,75 - 90 fps	MXF/ARRIRAW MFX/Apple ProRes 4444 MFX/Apple ProRes 4444 XQ MFX/Apple ProRes 422 HQ
 ALEXA LF 7,8 kg / 17,2 lbs (3)	Large Format ARRI ALEV 3 (A2X) CMOS sensor with Bayer pattern color filter array	4448 x 3096 36.70 x 25.54 mm 1.444 x 1.005" Ø 44.71 mm / 1.760"	14+ stops EI 160 to EI 3200	0,75 - 150 fps	ARRIRAW Apple ProRes 422 HQ Apple ProRes 4444 XQ Apple ProRes 422 Apple ProRes 4444
 AMIRA 4,1 kg / 9,2 lbs (1)	Super 35 format ARRI ALEV 3 CMOS sensor with Bayer pattern color filter array	3200 x 1800 26.40 x 14.85 mm 1.039 x 0.585" Ø 30.29 mm / 1.193"	14+ stops EI 160 to EI 3200	0,75 - 200 fps	MFX/ARRIRAW Apple ProRes 422 Apple ProRes 4444 XQ Apple ProRes 422 LT Apple ProRes 4444 MPEG-2 HD Apple ProRes 422 HQ
 AMIRA Live 5,2 kg / 11,5 lbs (4)	Super 35 format ARRI ALEV 3 CMOS sensor with Bayer pattern color filter array	3200 x 1800 26.40 x 14.85 mm 1.039 x 0.585" Ø 30.29 mm / 1.193"	14+ stops EI 160 to EI 3200	0,75 - 200 fps	MFX/ARRIRAW Apple ProRes 422 Apple ProRes 4444 XQ Apple ProRes 422 LT Apple ProRes 4444 MPEG-2 HD Apple ProRes 422 HQ

(1) camera body with PL lens mount (2) camera body with LPL Mount (3) camera body & recording module & lens mount (4) camera body with AMIRA Live Fiber Adapter and PL lens mount

Camera Product Comparison - ARRI Camera Models - part II



Configuration Overview | 1.0.1 / 2025.07

Model / Weight	Viewfinder/Monitor	Recording Media	Power Input	Lens Mounts
 ALEXA 35 Xtreme Premium Model 2,9 kg / 6,4 lbs (1)	Multi Viewfinder MVF-2 with 4" flip-out monitor Camera Control Monitor CCM-1 7" high-bright touchscreen monitor	CODEX Compact Drive 1TB CODEX Compact Drive 2TB CODEX Compact Drive Express 1TB (5)	1x PWR (LEMO 8-pin) (20.5 - 33.6 V DC) 1x BAT (camera rear interface) (20.5 - 33.6 V DC)	ARRI LPL Mount (LBUS) ARRI PL (Hirose) ARRI PL-to-LPL Adapter ARRI EF Mount (LBUS) ARRI PL Mount (LBUS) Leitz M Mount for ARRI
 ALEXA 35 Xtreme Base Model 2,9 kg / 6,4 lbs (1)	Multi Viewfinder MVF-2 with 4" flip-out monitor Camera Control Monitor CCM-1 7" high-bright touchscreen monitor	CODEX Compact Drive 1TB CODEX Compact Drive 2TB CODEX Compact Drive Express 1TB (5)	1x PWR (LEMO 8-pin) (20.5 - 33.6 V DC) 1x BAT (camera rear interface) (20.5 - 33.6 V DC)	ARRI LPL Mount (LBUS) ARRI PL (Hirose) ARRI PL-to-LPL Adapter ARRI EF Mount (LBUS) ARRI PL Mount (LBUS) Leitz M Mount for ARRI
 ALEXA 35 Live 2,9 kg / 6,4 lbs (1)	Multi Viewfinder MVF-2 with 4" flip-out monitor Camera Control Monitor CCM-1 7" high-bright touchscreen monitor	CODEX Compact Drive 1TB CODEX Compact Drive 2TB CODEX Compact Drive Express 1TB (5)	1x PWR (LEMO 8-pin) (20.5 - 33.6 V DC) 1x BAT (camera rear interface) (20.5 - 33.6 V DC)	ARRI LPL Mount (LBUS) ARRI PL (Hirose) ARRI PL-to-LPL Adapter ARRI EF Mount (LBUS) ARRI PL Mount (LBUS) Leitz M Mount for ARRI
 ALEXA Mini LF 2,6 kg / 5,7 lbs (2)	Multi Viewfinder MVF-2 with 4" flip-out monitor Camera Control Monitor CCM-1 7" high-bright touchscreen monitor	CODEX Compact Drive 1TB CODEX Compact Drive 2TB	1x LEMO 8pin (11-34 V DC)	ARRI PL Mount (LBUS) ARRI EF Mount (LBUS) ARRI PL-to-LPL Adapter Leitz M Mount for ARRI
 ALEXA LF 7,8 kg / 17,2 lbs (3)	Electronic Viewfinder EVF-1 with 235 eyepiece Electronic Viewfinder EVF-2 with ARRICAM eyepiece	SXR Capture Drives SxS PRO+ Cards	1x Fischer 2pin BAT connector (18.5-34 V DC) 1x On-board battery interface (19.5-34 V DC)	LPL lens mount PL lens mount ARRI PL-to-LPL Adapter
 AMIRA 4,1 kg / 9,2 lbs (1)	Multi Viewfinder MVF-1 with 3,2" flip-out monitor Camera Control Panel (CCP-1) with option to daisy-chain MVF-1	CFast 2.0 Cards	1x Fischer 2pin BAT connector (10.5-34 V DC) 1x On-board battery interface (10.5-34 V DC)	ARRI PL (Hirose) ARRI PL Mount (LBUS) EF lens mount Leitz M Mount for ARRI B4 (Hirose) ARRI PL-to-LPL Adapter
 AMIRA Live 5,2 kg / 11,5 lbs (4)	Multi Viewfinder MVF-1 with 3,2" flip-out monitor Camera Control Panel (CCP-1) with option to daisy-chain MVF-1	CFast 2.0 Cards	1x LEMO 8pin (10.5-34 V DC) 12.0 V to 17.0 V DC via Lemo 2-pin on FCA	ARRI PL (Hirose) ARRI PL Mount (LBUS) EF lens mount Leitz M Mount for ARRI B4 (Hirose) ARRI PL-to-LPL Adapter

(1) camera body with PL lens mount (2) camera body with LPL Mount (3) camera body & recording module & lens mount (4) camera body with AMIRA Live Fiber Adapter and PL lens mount (5) ProRes only

ALEXA 35 Xtreme - Feature Licenses



Configuration Overview | 1.1.0 / 2025.07

	pre-installed licenses when ordering an ALEXA 35 Xtreme		Licences for individual purchase					
	Premium License	Basic License	Premium	High Speed	ARRIRAW	Open Gate / Anamorphic	Pre-record	Look
Permanent	pre-installed	pre-installed	10.0053851	10.0052056	10.0052061	10.0052065	10.0052069	10.0052073
Temporary - 1 Year	-	-	10.0053853	10.0052058	10.0052062	10.0052066	10.0052070	10.0052074
Temporary - 30 days	-	-	10.0053854	10.0052059	10.0052063	10.0052067	10.0052071	10.0052075
Temporary - 7 days	-	-	10.0053855	10.0052060	10.0052064	10.0052068	10.0052072	10.0052076
0.75 - 60 fps	✓	✓						
ProRes Recording	✓	✓						
Enhanced Sensitivity	✓	✓						
ARRI Color Management (in-camera SDR & HDR DRTs)	✓	✓						
Basic 16:9 & 2:1 Spherical Recording Formats	✓	✓						
ARRI Look File (CDL & 3D LUTs)	✓	✓						
ARRICORE Recording	✓	✓						
Max fps for every available codec/recording format	✓		✓	✓				
ARRIRAW	✓		✓		✓			
Open Gate Recording Formats	✓		✓			✓		
Anamorphic Recording Formats	✓		✓			✓		
Anamorphic De-squeeze in Monitor Path	✓		✓			✓		
Pre-recording	✓		✓				✓	
ARRI Textures	✓		✓					✓
Look Library	✓		✓					✓
Custom Color Management	✓		✓					✓

ALEXA 35 Xtreme - Base Camera Set Options



Configuration Overview | 1.1.1 / 2025.07

Basic Sets



ALEXA 35 Xtreme Base Entry Set (LPL, CCM), K0.0055015
includes:
K1.0053455 1x ALEXA 35 Xtreme with Base License
K2.0018983 1x ARRI LPL Mount (LBUS)
K2.0016936 1x ARRI PL-to-LPL Adapter
K2.0034180 1x Balance Utility Dovetail BUD-1
K2.0023751 1x B-Mount Battery Adapter
KK.0048851 1x Camera Control Monitor CCM-1 Set
K2.0024745 1x Bridge Plate Adapter BPA-6
K2.0017270 1x Center Camera Handle CCH-4
K2.0034179 1x Universal Adapter Plate UAP-3



ALEXA 35 Xtreme Base Operator Set (PL, MVF), K0.0055017, includes:
K1.0053455 1x ALEXA 35 Xtreme with Base License
K2.0042652 1x ARRI PL Mount (Hirose)
K2.0034180 1x Balance Utility Dovetail BUD-1
K2.0023751 1x B-Mount Battery Adapter
K2.0020916 1x Multi Viewfinder MVF-2
K2.0042857 2x Cable VF Right Angle (0.5m/1.5ft)
KK.0051696 1x Operator Set



ALEXA 35 Xtreme Base Operator Set (LPL, MVF-2), K0.0055019, includes:
K1.0053455 1x ALEXA 35 Xtreme with Base License
K2.0018983 1x ARRI LPL Mount (LBUS)
K2.0016936 1x ARRI PL-to-LPL Adapter
K2.0034180 1x Balance Utility Dovetail BUD-1
K2.0023751 1x B-Mount Battery Adapter
K2.0020916 1x Multi Viewfinder MVF-2
K2.0042857 2x Cable VF Right Angle (0.5m/1.5ft)
KK.0051696 1x Operator Set



ALEXA 35 Xtreme Base Production Set (LPL, MVF, 19mm), K0.0055021, includes:
K1.0053455 1x ALEXA 35 Xtreme with Base License
K2.0018983 1x ARRI LPL Mount (LBUS)
K2.0016936 1x ARRI PL-to-LPL Adapter
K2.0034180 1x Balance Utility Dovetail BUD-1
K2.0023751 1x B-Mount Battery Adapter
K2.0020916 1x Multi Viewfinder MVF-2
K2.0042857 2x Cable VF Right Angle (0.5m/1.5ft)
K2.75007.0 1x Camera Power Cable Straight 2m/6.6in KC-50
K2.0024101 1x Power Distribution Module PDM-1
KK.0041533 1x Production Support Set - Top
KK.0041534 1x Production Support Set - Side
KK.0041535 1x Production Support Set - Bottom (19mm)



ALEXA 35 Xtreme Base Entry Set (LPL, CCM, CDX), K0.0055016
includes:
K1.0053455 1x ALEXA 35 Xtreme with Base License
K2.0018983 1x ARRI LPL Mount (LBUS)
K2.0016936 1x ARRI PL-to-LPL Adapter
K2.0034180 1x Balance Utility Dovetail BUD-1
K2.0023751 1x B-Mount Battery Adapter
KK.0048851 1x Camera Control Monitor CCM-1 Set
K2.0024745 1x Bridge Plate Adapter BPA-6
K2.0017270 1x Center Camera Handle CCH-4
K2.0034179 1x Universal Adapter Plate UAP-3
K2.0053843 3x CODEX Compact Drive Express 1TB
K2.0024134 1x CODEX Compact Drive Reader (USB-C)



ALEXA 35 Xtreme Base Operator Set (PL, MVF-2, CDX), K0.0055018, includes:
K1.0053455 1x ALEXA 35 Xtreme with Base License
K2.0042652 1x ARRI PL Mount (Hirose)
K2.0034180 1x Balance Utility Dovetail BUD-1
K2.0023751 1x B-Mount Battery Adapter
K2.0020916 1x Multi Viewfinder MVF-2
K2.0042857 2x Cable VF Right Angle (0.5m/1.5ft)
K2.0053843 3x CODEX Compact Drive Express 1TB
K2.0024134 1x CODEX Compact Drive Reader (USB-C)
KK.0051696 1x Operator Set



ALEXA 35 Xtreme Base Operator Set (LPL, MVF-2, CDX), K0.0055020, includes:
K1.0053455 1x ALEXA 35 Xtreme with Base License
K2.0018983 1x ARRI LPL Mount (LBUS)
K2.0016936 1x ARRI PL-to-LPL Adapter
K2.0034180 1x Balance Utility Dovetail BUD-1
K2.0023751 1x B-Mount Battery Adapter
K2.0020916 1x Multi Viewfinder MVF-2
K2.0042857 2x Cable VF Right Angle (0.5m/1.5ft)
K2.0053843 3x CODEX Compact Drive Express 1TB
K2.0024134 1x CODEX Compact Drive Reader (USB-C)
KK.0051696 1x Operator Set



ALEXA 35 Xtreme Base Production Set (LPL, MVF, 15mm), K0.0055022, includes:
K1.0053455 1x ALEXA 35 Xtreme with Base License
K2.0018983 1x ARRI LPL Mount (LBUS)
K2.0016936 1x ARRI PL-to-LPL Adapter
K2.0034180 1x Balance Utility Dovetail BUD-1
K2.0023751 1x B-Mount Battery Adapter
K2.0020916 1x Multi Viewfinder MVF-2
K2.0042857 2x Cable VF Right Angle (0.5m/1.5ft)
K2.75007.0 1x Camera Power Cable Straight 2m/6.6in KC-50
K2.0024101 1x Power Distribution Module PDM-1
KK.0041533 1x Production Support Set - Top
KK.0041534 1x Production Support Set - Side
KK.0041536 1x Production Support Set - Bottom (15mm)

ALEXA 35 Xtreme - Premium Camera Set Options



Configuration Overview | 1.1.2 / 2025.10

Premium Sets



ALEXA 35 Xtreme Premium Production Set (19mm), K0.0055012, includes:
 KK.0055023 1x ALEXA 35 Xtreme with Premium License
 K2.0018983 1x ARRI LPL Mount (LBUS)
 K2.0016936 1x ARRI PL-to-LPL Adapter
 K2.0034180 1x Balance Utility Dovetail BUD-1
 K2.0023751 1x B-Mount Battery Adapter
 K2.0020916 1x Multi Viewfinder MVF-2
 K2.0042857 2x Cable VF Right Angle (0.5m/1.5ft)
 K2.75007.0 1x Camera Power Cable Straight 2m/6.6in KC-50
 K2.0024101 1x Power Distribution Module PDM-1
 KK.0041533 1x Production Support Set - Top
 KK.0041534 1x Production Support Set - Side
 KK.0041535 1x Production Support Set - Bottom (19mm)



ALEXA 35 Xtreme Premium Operator Set, K0.0055014, includes:
 KK.0055023 1x ALEXA 35 Xtreme with Premium License
 K2.0018983 1x ARRI LPL Mount (LBUS)
 K2.0016936 1x ARRI PL-to-LPL Adapter
 K2.0034180 1x Balance Utility Dovetail BUD-1
 K2.0023751 1x B-Mount Battery Adapter
 K2.0020916 1x Multi Viewfinder MVF-2
 K2.0042857 2x Cable VF Right Angle (0.5m/1.5ft)
 KK.0051696 1x Operator Set



ALEXA 35 Xtreme Premium Body & PL Mount Set, K0.0055025 includes:
 KK.0055023 1x ALEXA 35 Xtreme with Premium License
 K2.0034180 1x Balance Utility Dovetail BUD-1
 K2.0023751 1x B-Mount Battery Adapter
 K2.0042651 ARRI PL Lens Mount (LBUS)



ALEXA 35 Xtreme Premium Production Set (15mm), K0.0055013, includes:
 KK.0055023 1x ALEXA 35 Xtreme with Premium License
 K2.0018983 1x ARRI LPL Mount (LBUS)
 K2.0016936 1x ARRI PL-to-LPL Adapter
 K2.0034180 1x Balance Utility Dovetail BUD-1
 K2.0023751 1x B-Mount Battery Adapter
 K2.0020916 1x Multi Viewfinder MVF-2
 K2.0042857 2x Cable VF Right Angle (0.5m/1.5ft)
 K2.75007.0 1x Camera Power Cable Straight 2m/6.6in KC-50
 K2.0024101 1x Power Distribution Module PDM-1
 KK.0041533 1x Production Support Set - Top
 KK.0041534 1x Production Support Set - Side
 KK.0041536 1x Production Support Set - Bottom (15mm)



ALEXA 35 Xtreme Premium Body & LPL Mount Set, K0.0055024 includes:
 KK.0055023 1x ALEXA 35 Xtreme with Premium License
 K2.0034180 1x Balance Utility Dovetail BUD-1
 K2.0023751 1x B-Mount Battery Adapter
 K2.0018983 ARRI LPL Lens Mount (LBUS)
 K2.0016936 ARRI PL-to-LPL-Adapter

ALEXA 35 Xtreme with Premium License, KK.0055023 includes:
 K1.0053455 1x ALEXA 35 Xtreme with Base License
 10.0053856 1x Premium License ATO
 K5.0024646 Black Jog Wheel
 KK-Set available only as part of K0-Set

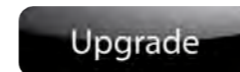

Upgrade ALEXA 35 to ALEXA 35 Xtreme, K0.0055048 includes:
 K4.0053686 1x ALEXA 35 Xtreme Upgrade Kit
 10.0000024 1x ALEXA 35 Upgrade Labor

Storage Media



CODEX Compact Drive Express 1TB, K2.0053843
CODEX Compact Dr Exp 1TB+Reader Bundle, K0.0053933



CODEX Compact Drive 2TB, K2.0023447
CODEX Compact Drive set 3x2TB, K0.0040251
CODEX Compact Drive set 6x2TB, KK.0040353



CODEX Compact Drive Dock (TB3), K2.0034320
 (CODEX# CDX.0001007)



CODEX Compact Drive 1TB, K2.0024130
CODEX Compact Drive set 3x1TB, K0.0024596
CODEX Compact Drive set 6x1TB, KK.0024370
CODEX Compact Drive set 12x1TB, K0.0048298



CODEX Compact Drive Reader (USB-C), K2.0024134
 (CODEX# CDX.0001005)

Electronic Accessories



Audio Extension Module AEM-1, K2.0023750



Power Distribution Module PDM-1, K2.0024101

ALEXA 35 Xtreme Sets & ALEXA 265 - Support Set Options



Configuration Overview | 1.1.3 / 2025.08

Production Sets



Top Accessory Set Production, [KK.0041533](#)

- includes:
- K2.0034178 1x Low Mode Support LMS-4
 - K2.0024062 1x Top Extension Bracket TEB-1
 - K2.0023519 1x Center Camera Handle CCH-5
 - K2.0047906 1x Square Accessory Sleeve SAS-2
 - K2.0033859 1x Viewfinder Mounting Bracket VMB-5



Production Support Set - Side, [KK.0041534**](#)

- includes:
- K2.0033571 1x Camera Side Bracket CSB-1R
 - K2.0033573 1x Camera Side Bracket CSB-1L
 - K2.0034189 1x Camera Side Bracket CSB-1R Extension
 - K2.0023907 1x Rod Mounting Bracket RMB-7
 - K2.0034182 1x Articulated Mounting Plate AMP-1

Production Support Set - Bottom (19mm), [KK.0041535](#)

- includes:
- K2.0023549 1x Compact Bridge Plate CBP-5 (19mm)
 - K2.0015896 1x Bottom Dovetail Plate 300mm/12in

Production Support Set - Bottom (15mm), [KK.0041536](#)

- includes:
- K2.0023836 1x Compact Bridge Plate CBP-6 (15mm)
 - K2.0015896 1x Bottom Dovetail Plate 300mm/12in



Operator Sets



Operator Set, [KK.0051696](#)

- includes:
- K2.0049425 1x Top Operator Grip TOG-1
 - K2.0049422 1x Top Operator Plate TOP-1
 - K2.0049959 1x Touchdown Base Plate TBP-1
 - K2.0049960 1x Touchdown Receiver Plate TRP-1

ALEXA 35 Xtreme Premium Body & LPL Mount Set, [K0.0055024](#)

- includes:
- KK.0055023 1x ALEXA 35 Xtreme with Premium License
 - K2.0034180 1x Balance Utility Dovetail BUD-1
 - K2.0023751 1x B-Mount Battery Adapter
 - K2.0018983 ARRI LPL Lens Mount (LBUS)
 - K2.0016936 ARRI PL-to-LPL-Adapter



ALEXA 35 Xtreme Premium Body & PL Mount Set, [K0.0055025](#)

- includes:
- KK.0055023 1x ALEXA 35 Xtreme with Premium License
 - K2.0034180 1x Balance Utility Dovetail BUD-1
 - K2.0023751 1x B-Mount Battery Adapter
 - K2.0042651 ARRI PL Lens Mount (LBUS)

MVF-2 Viewfinder Set, [K0.0042899](#)

- includes:
- K2.0020916 1x Multi Viewfinder MVF-2
 - K2.0042857 2x Cable VF Right Angle (0.5m/1.5ft)



Viewfinder Mounting Set Cross Pipe, [KK.0013311](#)

- includes:
- K2.0013302 1x Viewfinder Cross Pipe
 - K2.0006186 1x Rod Mounting Bracket RMB-3

Viewfinder Mounting Set VMB-5, [KK.0034527](#)

- includes:
- K2.0033859 1x Viewfinder Mounting Bracket VMB-5
 - K2.0047906 1x Square Accessory Sleeve SAS-2



Handle Extension Set for ALEXA 35, [KK.0051730](#), includes:

- K2.0019791 1x Handle Extension HEX-1
- K2.0019792 1x Handle Extension HEX-2
- K2.0019797 1x Handle Extension HEX-3
- K2.0019798 1x Handle Extension HEX-4
- K2.0036917 1x Handle Extension HEX-5
- K2.0019810 1x Handle Extension HEX-90
- K2.0037131 1x Wooden Shell for HEX
- K2.0049050 1x Handle Extension HEX-A

Lightweight Sets



Lightweight Support Set - Top, [KK.0041537](#)

- includes:
- K2.0034179 1x Universal Adapter Plate UAP-3
 - K2.0024062 1x Top Extension Bracket TEB-1
 - K2.0024066 1x Lightweight Camera Handle LCH-1
 - K2.0034554 1x Balance Harness Adapter BHA-1
 - K2.0023948 1x Lightweight Support LWS-6
 - K2.0006186 1x Rod Mounting Bracket RMB-3
 - K2.0013302 1x Viewfinder Cross Pipe



Lightweight Support Set - Side, [KK.0041538**](#)

- includes:
- K2.0033571 1x Camera Side Bracket CSB-1R
 - K2.0033573 1x Camera Side Bracket CSB-1L
 - K2.0034189 1x Camera Side Bracket CSB-1R Extension
 - K2.0023907 1x Rod Mounting Bracket RMB-7



Lightweight Support Set - Bottom, [KK.0041539](#)

- includes:
- K2.0024745 1x Bridge Plate Adapter BPA-6
 - K2.0024161 1x Compact Shoulder Pad CSP-2

** not compatible with ALEXA 265

ALEXA 35 Xtreme & ALEXA 265 - Single Component Options



Configuration Overview | 1.1.4 / 2025.10

Camera & Electronic Components



ALEXA 35 Xtreme with Base License, K1.0053455



Multi Viewfinder MVF-2, [K2.0020916](#)



ARRI LPL Mount (LBUS), [K2.0018983](#)



ARRI PL Mount (LBUS), [K2.0042651](#)



ARRI PL Mount (Hirose), [K2.0042652](#)



ARRI EF Mount (LBUS), [K2.0019965](#)



ARRI PL-to-LPL Adapter [K2.0016936](#)



Audio Extension Module AEM-1, [K2.0023750](#)



External Power Adapter EPA-1, [K2.0034205](#)



Power Distribution Module PDM-1, [K2.0024101](#)



B-Mount Battery Adapter, [K2.0023751](#)



Battery Adapter Back BAB-LF, [K2.0034204](#)



Audio Extension Module AEM-1 Set, [K0.0054747](#), includes:
K2.0023750 1x Audio Extension Module AEM-1
K2.0054667 1x Audio Breakout AB-7 Right Angle
K2.0054668 1x Breakout Box Side Mounting Bracket



Audio Breakout AB-7 Right Angle, [K2.0054667](#)



Camera Control Monitor CCM-1 Set, [KK.0048851](#), includes
K2.0048523 1x CCM-1 with Foldable Sunhood, Screen Protector
K2.0048394 1x Monitor Arm for Camera MAC-1
K2.0023943 1x Cable VF (0.5m/1.5ft)
K2.0001637 1x Cable RS - RS/PWR IN (0.5m/1.6ft)



CCM-1 Ethernet Adapter [K2.0048980](#)

Components Top



Center Camera Handle CCH-5, [K2.0023519](#)



Lightweight Camera Handle LCH-1, [K2.0024066](#)



Universal Adapter Plate UAP-3, [K2.0034179](#)



Top Extension Bracket TEB-1, [K2.0024062](#)



Low Mode Support LMS-4, [K2.0034178](#)



Adjustable Top Plate for MöVI, [K2.0024181](#)



Balance Harness Adapter BHA-1, [K2.0034554](#)



Lightweight Support LWS-6, [K2.0023948](#)



Lightweight Support LWS-7, [K2.0050467](#)



Viewfinder Mounting Bracket VMB-5, [K2.0033859](#)



Viewfinder Cross Pipe, [K2.0013302](#)



Vertical Top Plate, [K2.0043666](#)



Square Acc. Sleeve SAS-2, [K2.0047906](#)



Monitor Arm for Camera MAC-1, [K2.0048394](#)



Viewfinder Adapter VFA-3, [K2.0048079](#)



Viewfinder Adapter VFA-4, [K2.0048510](#)



Top Operator Grip TOG-1, [K2.0049425](#)



Top Operator Plate TOP-1, [K2.0049422](#)



Universal Adapter Plate UAP-5, [K2.0052288](#)

** not compatible with ALEXA 265

Components Side & Rear



Camera Side Bracket CSB-1R Extension, [K2.0034189](#) **



Camera Side Bracket CSB-1L, [K2.0033573](#)



Camera Side Bracket CSB-1R, [K2.0033571](#) **



Breakout Box Side Mounting Bracket, [K2.0054668](#)



Rear Accessory Bracket RAB-2, [K2.0034183](#)



Rod Mounting Bracket RMB-7, [K2.0023907](#)



Articulated Mounting Plate AMP-1, [K2.0034182](#)

Case



Case for ALEXA 35, [K2.0040234](#)

Storage Media



CODEX Compact Drive 2TB [K2.0023447](#)
CODEX Compact Drive set 3x2TB, [K0.0040251](#)
CODEX Compact Drive set 6x2TB, [KK.0040353](#)



CODEX Compact Drive 1TB [K2.0024130](#)
CODEX Compact Drive set 3x1TB, [K0.0024596](#)
CODEX Compact Drive set 6x1TB, [KK.0024370](#)
CODEX Compact Drive set 12x1TB, [K0.0048298](#)



CODEX Compact Drive Express 1TB, [K2.0053843](#)



CODEX Compact Drive Dock (TB3), [K2.0034320](#) (CODEX# CDX.0001007)



CODEX Compact Dr Exp 1TB+Reader Bundle, [K0.0053933](#)



Transcend JF890S USB Flash Drive 64GB, [K2.0043663](#)

Components Bottom



Balance Utility Dovetail BUD-1, [K2.0034180](#)



Compact Shoulder Pad CSP-2, [K2.0024161](#)



Compact Bridge Plate CBP-5LW (19mm), [K2.0049300](#)



Compact Bridge Plate CBP-6LW (15mm), [K2.0049301](#)



Compact Bridge Plate CBP-5 (19mm), [K2.0023549](#)



Compact Bridge Plate CBP-6 (15mm), [K2.0023836](#)



Bridge Plate Adapter BPA-6, [K2.0024745](#)



Stabilizer Adapter Mount SAM-5, [K2.0024572](#)



Stabilizer Adapter Mount SAM-6 250mm/10", [K2.0024508](#)



Stabilizer Adapter Mount SAM-6 355mm/14in, [K2.0048425](#)



Stabilizer Adapter Mount SAM-7, [K2.0024511](#)



Stabilizer Adapter Mount SAM-6 450mm/18in, [K2.0039405](#)



Stabilizer Adapter Mount SAM-8, [K2.0044479](#)



Stabilizer Adapter Mount SAM-9, [K2.0041949](#)



Stabilizer Adapter Mount SAM-10, [K2.0049873](#)



Universal Adapter Plate UAP-4, [K2.0043674](#)



Vertical Format Baseplate, [K2.0042610](#) **



Vertical Format Set for ALEXA 35, [KK.0043836](#) **

ALEXA 35 Xtreme & ALEXA 265 - Component Options Top



Configuration Overview | 1.1.5 / 2025.08

Top Components and Viewfinder

Top Accessory Set Production, [KK.0041533](#)

includes:
 K2.0034178 1x Low Mode Support LMS-4
 K2.0024062 1x Top Extension Bracket TEB-1
 K2.0023519 1x Center Camera Handle CCH-5
 K2.0047906 1x Square Accessory Sleeve SAS-2
 K2.0033859 1x Viewfinder Mounting Bracket VMB-5



Lightweight Support Set - Top, [KK.0041537](#)

includes:
 K2.0034179 1x Universal Adapter Plate UAP-3
 K2.0024062 1x Top Extension Bracket TEB-1
 K2.0024066 1x Lightweight Camera Handle LCH-1
 K2.0034554 1x Balance Harness Adapter BHA-1
 K2.0023948 1x Lightweight Support LWS-6
 K2.0006186 1x Rod Mounting Bracket RMB-3
 K2.0013302 1x Viewfinder Cross Pipe



MVF-2 Viewfinder Set, [K0.0042899](#)

includes:
 K2.0020916 1x Multi Viewfinder MVF-2
 K2.0042857 2x Cable VF Right Angle (0.5m/1.5ft)



Viewfinder Mounting Set VMB-5, [KK.0034527](#)

includes:
 K2.0033859 1x Viewfinder Mounting Bracket VMB-5
 K2.0047906 1x Square Accessory Sleeve SAS-2



Camera Control Monitor CCM-1 Set, [KK.0048851](#), includes

K2.0048523 1x CCM-1 with Foldable Sunhood, Screen Protector
 K2.0048394 1x Monitor Arm for Camera MAC-1
 K2.0023943 1x Cable VF (0.5m/1.5ft)
 K2.0001637 1x Cable RS - RS/PWR IN (0.5m/1.6ft)



Attaches to any receptacles for two 15mm lightweight rods, as can be found in the LMS-4 or LWS-6

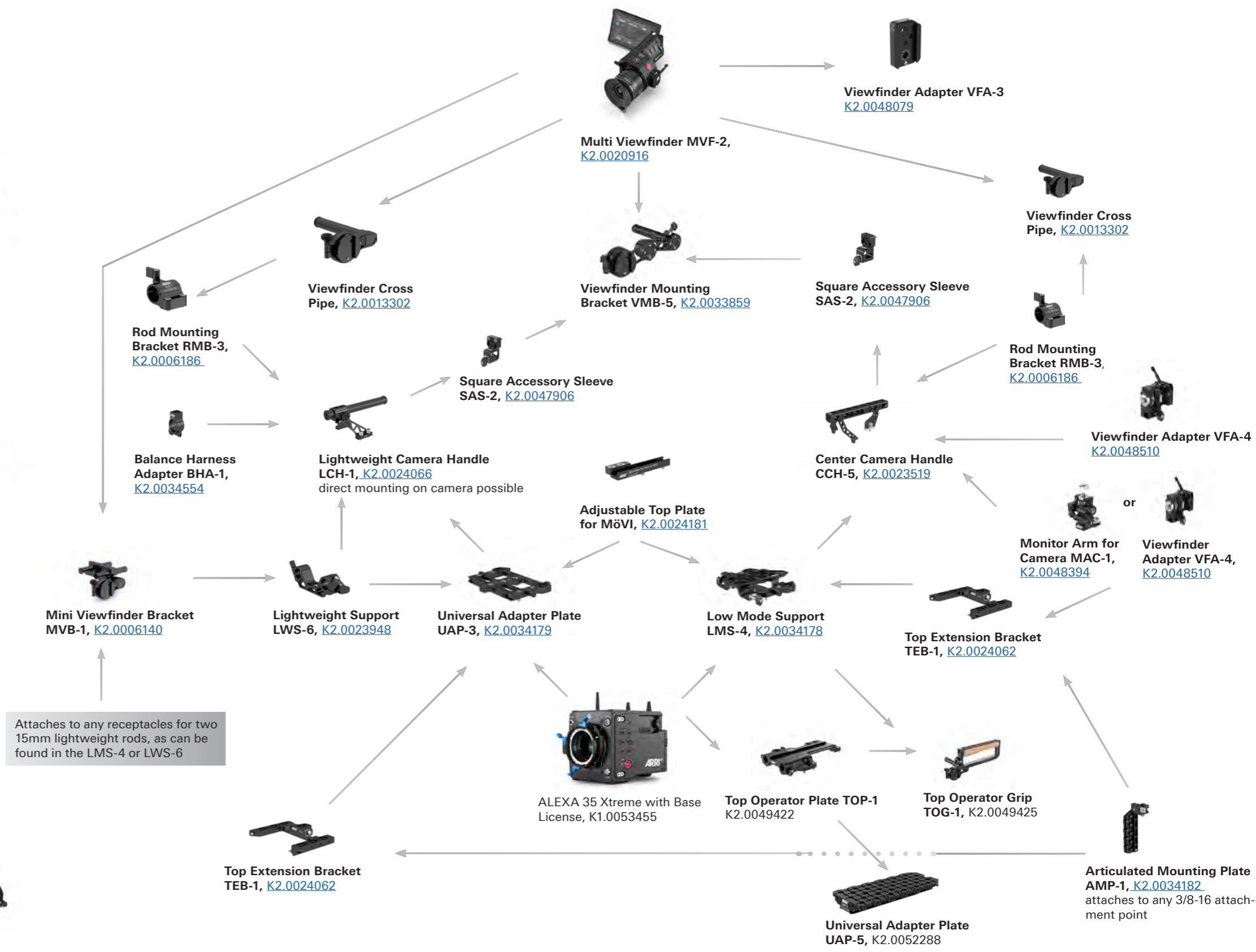

ALEXA 35 Xtreme & ALEXA 265 - Component Options Side & Rear



Configuration Overview | 1.1.6 / 2025.07

Side Components

Production Support Set - Side, [KK.0041534](#) **

- includes:
- K2.0033571 1x Camera Side Bracket CSB-1R
 - K2.0033573 1x Camera Side Bracket CSB-1L
 - K2.0034189 1x Camera Side Bracket CSB-1R Extension
 - K2.0023907 1x Rod Mounting Bracket RMB-7
 - K2.0034182 1x Articulated Mounting Plate AMP-1



Lightweight Support Set - Side, [KK.0041538](#) **

- includes:
- K2.0033571 1x Camera Side Bracket CSB-1R
 - K2.0033573 1x Camera Side Bracket CSB-1L
 - K2.0034189 1x Camera Side Bracket CSB-1R Extension
 - K2.0023907 1x Rod Mounting Bracket RMB-7



Vertical Format Set for ALEXA 35, [KK.0043836](#) **

- includes:
- K2.0019443 1x Vertical Viewfinder Adapter
 - K2.0043666 1x Vertical Top Plate
 - K2.0042610 1x Vertical Format Baseplate

** not compatible with ALEXA 265



Top Extension Bracket
TEB-1, [K2.0024062](#)



ALEXA 35 camera body,
[K1.0039373](#)



Balance Utility Dovetail
BUD-1, [K2.0034180](#)



Rear Accessory Bracket
RAB-2, [K2.0034183](#)



Articulated Mounting Plate
AMP-1, [K2.0034182](#)

A large number of 3/8-16, 1/4-20 and M4 attachment points on a hinged chees plate allow various accessories to be attached



Rod Mounting Bracket
RMB-7, [K2.0023907](#)



Universal Adapter Plate
UAP-4, [K2.0043674](#)



Vertical Format Baseplate,
K2.0042610 **



Camera Side Bracket CSB-1R
Extension, [K2.0034189](#) **



Camera Side Bracket CSB-1R,
[K2.0033571](#) **



** not compatible with ALEXA 265



Vertical Format Set for
ALEXA 35, [KK.0043836](#) **



Camera Side Bracket
CSB-1L, [K2.0033573](#)

ALEXA 35 Xtreme & ALEXA 265 - Component Options Bottom



Configuration Overview | 1.1.7 / 2026.03

Bottom Components

Production Support Set - Bottom (19mm), [KK.0041535](#)

includes:
K2.0023549 1x Compact Bridge Plate CBP-5 (19mm)
K2.0015896 1x Bottom Dovetail Plate 300mm/12in



Production Support Set - Bottom (15mm), [KK.0041536](#)

includes:
K2.0023836 1x Compact Bridge Plate CBP-6 (15mm)
K2.0015896 1x Bottom Dovetail Plate 300mm/12in



Lightweight Support Set - Bottom , [KK.0041539](#)

includes:
K2.0024745 1x Bridge Plate Adapter BPA-6
K2.0024161 1x Compact Shoulder Pad CSP-2



Touchdown Base Plate TBP-1, K2.0049959



Touchdown Receiver Plate TRP-1, K2.0049960



ALEXA 35 Xtreme with Base License, K1.0053455



Balance Utility Dovetail BUD-1, [K2.0034180](#)



Lightweight Support LWS-7, K2.0050467



Universal Adapter Plate UAP-4, K2.0043674



Compact Shoulder Pad CSP-2, [K2.0024161](#)



Stabilizer Adapter Mount SAM-5, [K2.0024572](#)

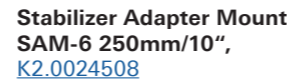

Stabilizer Adapter Mount SAM-6 250mm/10in, [K2.0024508](#)

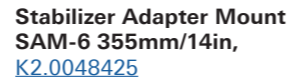

Stabilizer Adapter Mount SAM-6 355mm/14in, [K2.0048425](#)

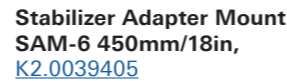

Stabilizer Adapter Mount SAM-6 450mm/18in, [K2.0039405](#)

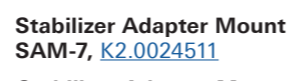

Stabilizer Adapter Mount SAM-7, [K2.0024511](#)

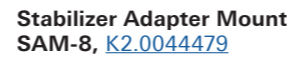

Stabilizer Adapter Mount SAM-8, [K2.0044479](#)

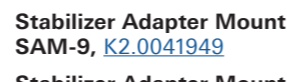

Stabilizer Adapter Mount SAM-9, [K2.0041949](#)

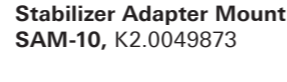

Stabilizer Adapter Mount SAM-10, K2.0049873



Bridge Plate Adapter BPA-6, [K2.0024745](#)



Lightweight Tripod Plate LTP-1, K2.0055367



Compact Bridge Plate CBP-5LW (19mm), K2.0049300



Compact Bridge Plate CBP-6LW (15mm), K2.0049301



Compact Bridge Plate CBP-6 (15mm), [K2.0023836](#)



Compact Bridge Plate CBP-5 (19mm), [K2.0023549](#)

Unscrew Touch 35 bottom to use



Bridge Plate BP-8 19 mm, [K2.0031436](#)



Bridge Plate BP-9 15 mm, [K2.0031435](#)



Bottom Dovetail Plate 300mm/12in, [K2.0015896](#)



Compact Shoulder Pad CSP-2, [K2.0024161](#)

ALEXA 35 Xtreme & ALEXA 265 - Powered Component Options



Configuration Overview | 1.1.8 / 2025.10

Storage Media



CODEX Compact Drive Express 1TB,
K2.0053843
CODEX Compact Dr Exp 1TB+Reader
Bundle, K0.0053933



CODEX Compact Drive 2TB
K2.0023447
CODEX Compact Drive set 3x2TB
K0.0040251
CODEX Compact Drive set 6x2TB
KK.0040353



CODEX Compact Drive 1TB
K2.0024130
CODEX Compact Drive set 3x1TB
K0.0024596
CODEX Compact Drive set 6x1TB
KK.0024370
CODEX Compact Drive set 12x1TB
KK.0048298

Most Compact Drive 1TB need a firmware update, which can be applied by ALEXA 35 in-camera



CODEX Compact Drive Dock (TB3)
K2.0034320 (Codex# CDX.0001007)



CODEX Compact Drive Reader (USB-C)
K2.0024134 (Codex# CDX.0001005)

Powered Components

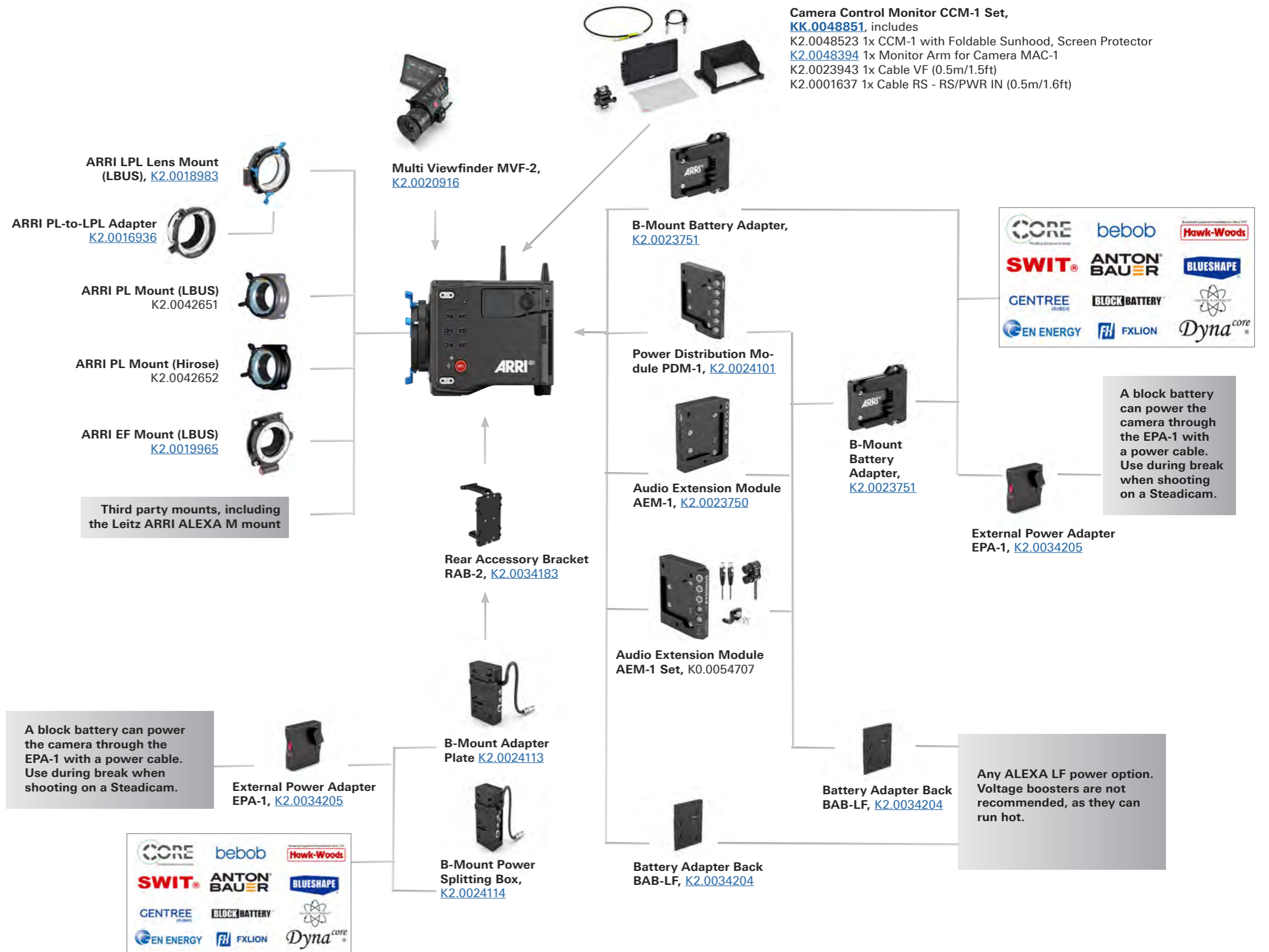

ALEXA 35 Xtreme & ALEXA 265 - Stabilizer Adapter Mount SAM



Configuration Overview | 1.1.9 / 2025.07

The Stabilizer Adapter Mount SAM-10 is not displayed on this page. See page 1.1.7

MöVI M15
MöVI Pro



Adjustable Top Plate
[K2.0024181](#)



Stabilizer Adapter Mount
SAM-5, [K2.0024572](#)

ARRI TRINITY Gen.1/2
ARRI MAXIMA
ARRI ARTEMIS 2



Stabilizer Adapter Mount
SAM-6 250mm/10",
[K2.0024508](#)

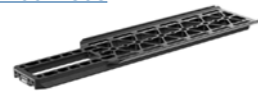

Stabilizer Adapter Mount
SAM-6 355mm/14in,
[K2.0048425](#)

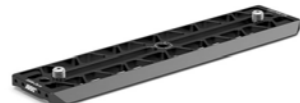

Stabilizer Adapter Mount
SAM-Zero, [K2.0041201](#)



Dovetail Utility Base
DUB-1, [K2.0039861](#)

The SAM-6 450mm/18in fits the ARRI TRINITY 1/2, MAXIMA and Artemis 2 stabilizers, however the 450mm plate is designed to support longer camera builds on SRH-3/360 and may compromise movements on body held stabilizers.

ARRI artemis 1
GPi PRO Stabilizers



Stabilizer Adapter Mount
SAM-7, [K2.0024511](#)

Tiffen Steadicam
M1, M2, Volt



Stabilizer Adapter Mount
SAM-8, [K2.0044479](#)



Dovetail Utility Base
DUB-2, [K2.0044813](#)

SAM-7 and SAM-8 have the same dovetail size. The SAM-8 is longer and features bottom safety stops optimized for Tiffen Steadicam units

ARRI SRH-360
ARRI SRH-3



Stabilizer Adapter Mount
SAM-6 450mm/18in,
[K2.0039405](#)



Rod Mounting Bracket
RMB-9, [K2.0049530](#)



Stabilizer System Bracket
SSB-2 19mm, [K2.0038537](#)

Stabilizer System Bracket
SSB-2 15mm, [K2.0038618](#)



Stabilizer Adapter Mount
SAM-6 250mm/10",
[K2.0024508](#)

The long SAM-6 (450mm) supports long zooms, e.g. Signature Zoom 65-300mm, on the ARRI SRH heads.

Dji Ronin 2



Stabilizer Adapter Mount
SAM-9, [K2.0041949](#)



Adapter Ronin 2 to Camera
Top Plate, [K2.0048854](#)



Adjustable Top Plate
[K2.0024181](#)

ALEXA Mini LF Ready to Shoot Sets



ALEXA Mini LF Ready to Shoot Set V, [K0.0024313](#) ALEXA Mini LF Ready to Shoot Set Gold, [K0.0024312](#) ALEXA Mini LF Ready to Shoot Set B, [K0.0024852](#)

- includes:
- K1.0024074 1x ALEXA Mini LF camera body
 - K2.0018983 1x ARRI LPL Mount (LBUS)
 - K2.0016936 1x ARRI PL-to-LPL Adapter
 - K2.0024130 2x Codex Compact Drive 1TB (CA08-1024)
 - K2.0020916 1x ALEXA Mini LF Multi Viewfinder MVF-2
 - K2.0023915 1x Cable VF (0.35m/1.15ft)
 - K2.0023943 1x Cable VF (0.5m/1.5ft)
 - K2.0023839 1x Mini Adapter Plate MAP-2A
 - K2.0006140 1x Mini Viewfinder Bracket MVB-1
 - K2.73002.0 1x Center Camera Handle CCH-2
 - K2.0023546 1x Mini Side Bracket MSB-3
 - K2.0014957 1x Mini Side Bracket MSB-2
 - K2.0014894 1x Compact Bridge Plate CBP-1 19mm
 - K2.0013937 1x Rear Accessory Bracket RAB-1
 - K2.0023406 1x RAB-1 Clamp 2
 - K2.0006186 1x Rod Mounting Bracket RMB-3
 - K2.66255.0 1x 15mm Reduction Insert
 - K2.0015896 1x Bottom Dovetail Plate 300mm/12in
 - K2.75007.0 1x AMIRA Power Cable Straight 2m/6.6in KC-50
- Set V:** K2.0014530 1x V-mount Power Splitting Box MkII **OR**
Set G: K2.0014532 1x Gold Mount Power Splitting Box Mk II **OR**
Set B: K2.0024114 1x B-Mount Power Splitting Box

for further sets please see current price list

ALEXA Mini LF with MVF-2 Sets



ALEXA Mini LF Production Set 19 - MVF-2, [K0.0049871](#)

- includes:
- 1x K1.0024074 ALEXA Mini LF camera body
 - 1x K2.0018983 ARRI LPL Lens Mount ALEXA Mini/AMIRA
 - 1x K2.0016936 PL-to-LPL-Adapter
 - 3x K2.0024130 Codex Compact Drive 1TB (CA08-1024)
 - 1x K2.0020916 ALEXA Mini LF Multi Viewfinder MVF-2
 - 1x K2.0023915 Cable VF (0.35m/1.15ft)
 - 1x K2.0023943 Cable VF (0.5m/1.5ft)
 - 1x K2.0048463 Balance Utility Dovetail BUD-3
 - 1x K2.0023839 Mini Adapter Plate MAP-2A
 - 1x K2.0033859 Viewfinder Mounting Bracket VMB-5
 - 1x K2.0047906 Square Accessory Sleeve SAS-2
 - 1x K2.0017270 Center Camera Handle CCH-4
 - 1x K2.0019792 Handle Extension HEX-2
 - 1x K2.0019797 Handle Extension HEX-3
 - 1x K2.0012692 Side Accessory Bracket SAB-1
 - 1x K2.0023546 Mini Side Bracket MSB-3
 - 1x K2.0014957 Mini Side Bracket MSB-2
 - 1x K2.0023549 Compact Bridge Plate CBP-5 (19mm)
 - 1x K2.0049215 Rear Accessory Bracket RAB-3
 - 1x K2.0023406 Clamp 2 for RAB-1
 - 1x K2.0015896 Bottom Plate 300mm/12"
 - 1x K2.75007.0 Power Cable Straight KC-50 2m

ALEXA Mini LF Production Set 15 - MVF-2, [K0.0049869](#)

- includes:
- 1x K1.0024074 ALEXA Mini LF camera body
 - 1x K2.0018983 ARRI LPL Lens Mount ALEXA Mini/AMIRA
 - 1x K2.0016936 PL-to-LPL-Adapter
 - 3x K2.0024130 Codex Compact Drive 1TB (CA08-1024)
 - 1x K2.0020916 ALEXA Mini LF Multi Viewfinder MVF-2
 - 1x K2.0023915 Cable VF (0.35m/1.15ft)
 - 1x K2.0023943 Cable VF (0.5m/1.5ft)
 - 1x K2.0048463 Balance Utility Dovetail BUD-3
 - 1x K2.0023839 Mini Adapter Plate MAP-2A
 - 1x K2.0033859 Viewfinder Mounting Bracket VMB-5
 - 1x K2.0047906 Square Accessory Sleeve SAS-2
 - 1x K2.0017270 Center Camera Handle CCH-4
 - 1x K2.0019792 Handle Extension HEX-2
 - 1x K2.0019797 Handle Extension HEX-3
 - 1x K2.0012692 Side Accessory Bracket SAB-1
 - 1x K2.0023546 Mini Side Bracket MSB-3
 - 1x K2.0014957 Mini Side Bracket MSB-2
 - 1x K2.0023836 Compact Bridge Plate CBP-6 (15mm)
 - 1x K2.0049215 Rear Accessory Bracket RAB-3
 - 1x K2.0023406 Clamp 2 for RAB-1
 - 1x K2.0015896 Bottom Plate 300mm/12"
 - 1x K2.75007.0 Power Cable Straight KC-50 2m

ALEXA Mini LF with CCM-1 Sets



ALEXA Mini LF Production Set 19 - CCM-1, [K0.0049870](#)

- includes:
- 1x K1.0024074 ALEXA Mini LF camera body
 - 1x K2.0018983 ARRI LPL Lens Mount ALEXA Mini/AMIRA
 - 1x K2.0016936 PL-to-LPL-Adapter
 - 3x K2.0024130 Codex Compact Drive 1TB (CA08-1024)
 - 1x KK.0048851 Camera Control Monitor CCM-1 set
 - 1x K2.0023915 Cable VF (0.35m/1.15ft)
 - 1x K2.0048463 Balance Utility Dovetail BUD-3
 - 1x K2.0023839 Mini Adapter Plate MAP-2A
 - 1x K2.0017270 Center Camera Handle CCH-4
 - 1x K2.0019792 Handle Extension HEX-2
 - 1x K2.0019797 Handle Extension HEX-3
 - 1x K2.0012692 Side Accessory Bracket SAB-1
 - 1x K2.0023546 Mini Side Bracket MSB-3
 - 1x K2.0014957 Mini Side Bracket MSB-2
 - 1x K2.0023549 Compact Bridge Plate CBP-5 (19mm)
 - 1x K2.0049215 Rear Accessory Bracket RAB-3
 - 1x K2.0023406 Clamp 2 for RAB-1
 - 1x K2.0015896 Bottom Plate 300mm/12"
 - 1x K2.75007.0 Power Cable Straight KC-50 2m

ALEXA Mini LF Production Set 15 - CCM-1, [K0.0049868](#)

- includes:
- 1x K1.0024074 ALEXA Mini LF camera body
 - 1x K2.0018983 ARRI LPL Lens Mount ALEXA Mini/AMIRA
 - 1x K2.0016936 PL-to-LPL-Adapter
 - 3x K2.0024130 Codex Compact Drive 1TB (CA08-1024)
 - 1x KK.0048851 Camera Control Monitor CCM-1 set
 - 1x K2.0023915 Cable VF (0.35m/1.15ft)
 - 1x K2.0048463 Balance Utility Dovetail BUD-3
 - 1x K2.0023839 Mini Adapter Plate MAP-2A
 - 1x K2.0017270 Center Camera Handle CCH-4
 - 1x K2.0019792 Handle Extension HEX-2
 - 1x K2.0019797 Handle Extension HEX-3
 - 1x K2.0012692 Side Accessory Bracket SAB-1
 - 1x K2.0023546 Mini Side Bracket MSB-3
 - 1x K2.0014957 Mini Side Bracket MSB-2
 - 1x K2.0023836 Compact Bridge Plate CBP-6 (15mm)
 - 1x K2.0049215 Rear Accessory Bracket RAB-3
 - 1x K2.0023406 Clamp 2 for RAB-1
 - 1x K2.0015896 Bottom Plate 300mm/12"
 - 1x K2.75007.0 Power Cable Straight KC-50 2m

ALEXA Mini Expansion Sets



ALEXA Mini LF Lightweight Expansion Set, [K0.0049867](#)

- includes:
- 1x K2.0047697 Mini Adapter Plate MAP-4
 - 1x K2.0024066 Lightweight Camera Handle LCH-1
 - 1x K2.0034554 Balance Harness Adapter BHA-1
 - 1x K2.0023948 Lightweight Support LWS-6
 - 1x K2.0024745 Bridge Plate Adapter BPA-6
 - 1x K2.0024161 Compact Shoulder Pad CSP-2
 - 1x K2.0006186 Rod Mounting Bracket RMB-3
 - 1x K2.0013302 Viewfinder Cross Pipe



ALEXA Mini LF Ready to Shoot Expansion Set, [K0.0024684](#)

- includes:
- 1x K2.0014981 Stabilizer Plate for CBP
 - 1x K2.0001017 Handle Extension Block long, HEB-3
 - 1x K2.0023942 Battery Adapter Plate BAP-2A
 - 1x K2.0014960 Single Support Rod 90mm, 3.5in, Ø19mm
 - 1x K2.0014961 Single Support Rod 150mm, 5.9in, Ø19mm
 - 1x K2.0012692 Side Accessory Bracket SAB-1



Antenna Video/ECS, [K2.0014568](#)

Configuration Overview | 1.2.1 / 2024.07

ALEXA Mini LF



ALEXA Mini LF Ready to Shoot Set V, [K0.0024313](#)
ALEXA Mini LF Ready to Shoot Set Gold, [K0.0024312](#)

includes:

- K1.0024074 1x ALEXA Mini LF camera body
- K2.0018983 1x ARRI LPL Mount (LBUS)
- K2.0016936 1x ARRI PL-to-LPL Adapter
- K2.0024130 2x Codex Compact Drive 1TB (CA08-1024)
- K2.0020916 1x ALEXA Mini LF Multi Viewfinder MVF-2
- K2.0023915 1x Cable VF (0.35m/1.15ft)
- K2.0023943 1x Cable VF (0.5m/1.5ft)
- K2.0023839 1x Mini Adapter Plate MAP-2A
- K2.0006140 1x Mini Viewfinder Bracket MVB-1
- K2.73002.0 1x Center Camera Handle CCH-2
- K2.0023546 1x Mini Side Bracket MSB-3
- K2.0014957 1x Mini Side Bracket MSB-2
- K2.0014894 1x Compact Bridge Plate CBP-1 19mm
- K2.0013937 1x Rear Accessory Bracket RAB-1
- K2.0023406 1x RAB-1 Clamp 2
- K2.0006186 1x Rod Mounting Bracket RMB-3
- K2.66255.0 1x 15mm Reduction Insert
- K2.0015896 1x Bottom Dovetail Plate 300mm/12in
- K2.75007.0 1x AMIRA Power Cable Straight 2m/6.6in KC-50
- Set V:** K2.0014530 1x V-mount Power Splitting Box MkII
- Set G:** K2.0014532 1x Gold Mount Power Splitting Box Mk II

OR

for further sets please see current price list

Antenna Video/ECS, [K2.0014568](#)



ALEXA Mini LF Viewfinder

ALEXA Mini LF MVF-2 Set

- K0.0024311, includes:
- K2.0020916 1x Multi Viewfinder MVF-2
- K2.0023915 1x Cable VF (0.35m/1.15ft)
- K2.0023943 1x Cable VF (0.5m/1.5ft)



Heated Eycup, HE-7
 K2.0003898 (below 0°C)

- Cable VF (0.35m/1.15ft),** K2.0023915
- Cable VF (0.5m/1.5ft),** K2.0023943
- Cable VF (2m/6.5ft),** K2.0023944
- Cable VF (10m/33ft),** K2.0023945

ALEXA Mini LF Media and Readers



For details regarding Recording Medias please see Configuration Overview 1.9.0

Lens Mounts and Adapter

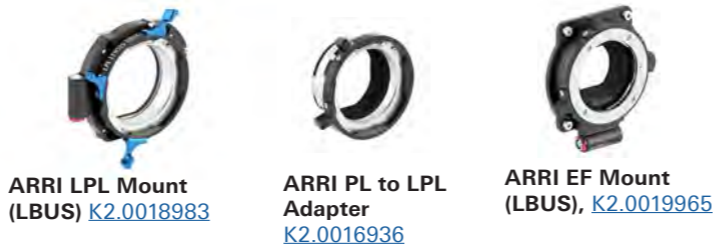

ARRI LPL Mount (LBUS) [K2.0018983](#)

ARRI PL to LPL Adapter
[K2.0016936](#)

ARRI EF Mount (LBUS), [K2.0019965](#)

CCM-1 Camera Control Monitor



Camera Control Monitor CCM-1 Set, [KK.0048851](#), includes
 K2.0048523 1x CCM-1 with Foldable Sunhood, Screen Protector
[K2.0048394](#) 1x Monitor Arm for Camera MAC-1
 K2.0023943 1x Cable VF (0.5m/1.5ft)
 K2.0001637 1x Cable RS - RS/PWR IN (0.5m/1.6ft)

CCM-1 Ethernet Adapter
 K2.0048980

Viewfinder Adapter VFA-4
 K2.0048510

Electronic Accessories

Transvideo Starlite HD5-ARRI 5" OLED Monitor [K2.0006960](#)

Starlite HD5 ARRI Ext cable angled, [K2.0008662](#)
Starlite HD5 ARRI Ext cable straight, [K2.0008663](#)

Transvideo Starlite ARRI-WVS
[K2.0015243](#)

General Purpose IO Box GPB-1, [K2.0007642](#) (cable incl.)

GPB-1 Mounting Bracket, K2.0008533

Cable ALEXA Mini/AMIRA EXT to GPB-1, [K2.0007736](#)

Splitting Boxes and Adapter Plates

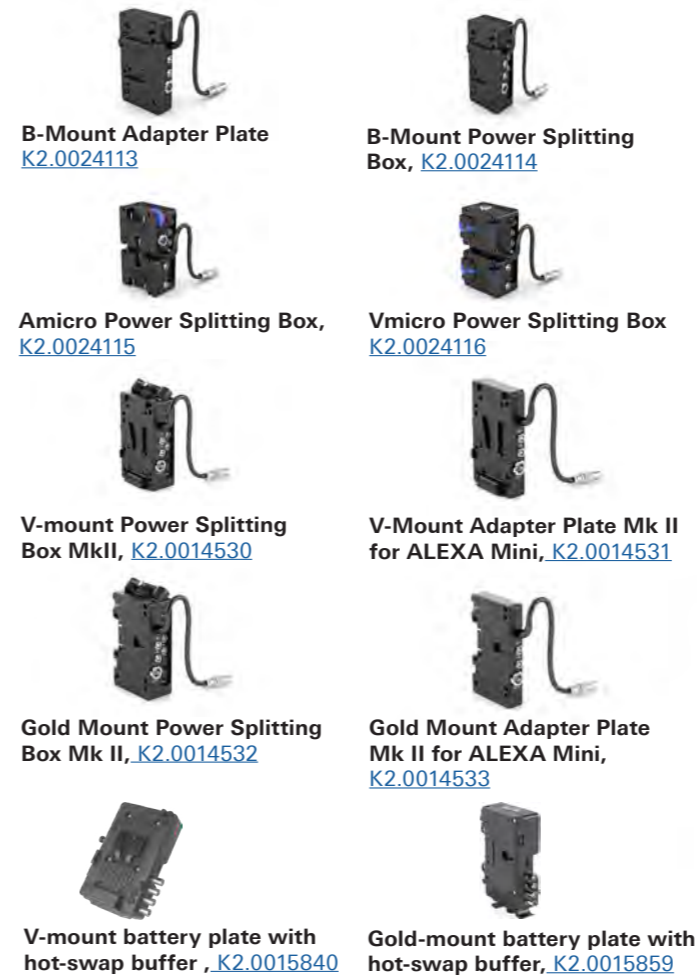

B-Mount Adapter Plate
[K2.0024113](#)

B-Mount Power Splitting Box, [K2.0024114](#)

Amicro Power Splitting Box, [K2.0024115](#)

Vmicro Power Splitting Box
[K2.0024116](#)

V-mount Power Splitting Box MkII, [K2.0014530](#)

V-Mount Adapter Plate Mk II for ALEXA Mini, [K2.0014531](#)

Gold Mount Power Splitting Box Mk II, [K2.0014532](#)

Gold Mount Adapter Plate Mk II for ALEXA Mini, [K2.0014533](#)

V-mount battery plate with hot-swap buffer, [K2.0015840](#)

Gold-mount battery plate with hot-swap buffer, [K2.0015859](#)

Power Cable Smart APU to ALEXA Mini 6' (1.85m), K2.0015861
Power Cable Smart APU to ALEXA Mini 2.6' (0.80m), K2.0015862
Power Cable Smart APU to ALEXA Mini (0.25m), K2.0015863

no pic available yet **Top support rod bracket 15mm LWS**
 K2.0015865

Cables & Power Supply

ARRI Power Supply Light 24V K2.0034493

Power Cable Straight KC-50 (2m, 6.6 feet), [K2.75007.0](#)

Ethernet Cable 3m KC 153-S, [K2.72021.0](#)
ALEXA Mini LF Audio connector with cable, K2.0023988
ALEXA Mini EXT to LCS, [K2.0007624](#)
ALEXA Mini EXT to EXT cable 1,5m (59 inch), K2.0009051

EXT-RS Adapter, [K2.0006170](#)

Electronic Control System

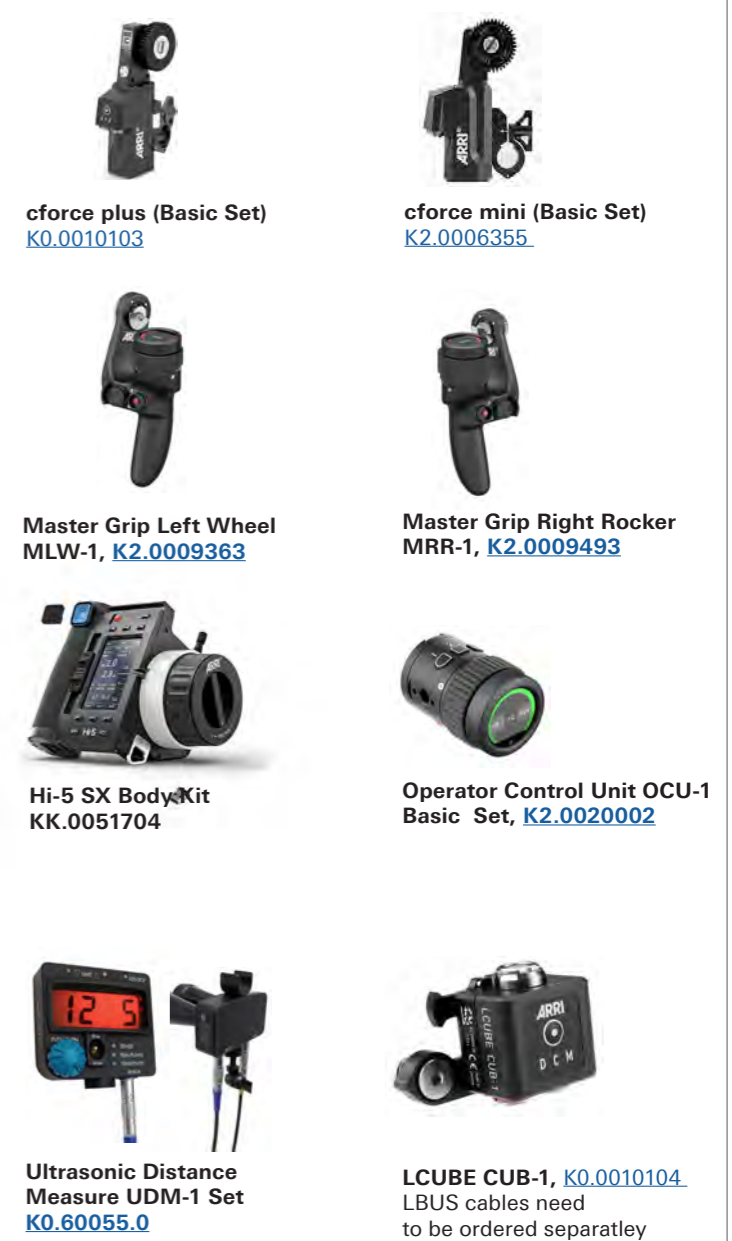

cforce plus (Basic Set)
[K0.0010103](#)

cforce mini (Basic Set)
[K2.0006355](#)

Master Grip Left Wheel MLW-1, [K2.0009363](#)

Master Grip Right Rocker MRR-1, [K2.0009493](#)

Hi-5 SX Body Kit
 KK.0051704

Operator Control Unit OCU-1 Basic Set, [K2.0020002](#)

Ultrasonic Distance Measure UDM-1 Set
[K0.60055.0](#)

LCUBE CUB-1, [K0.0010104](#)
 LBUS cables need to be ordered separately

- LBUS 0.2m/8",** [K2.0006749](#)
- LBUS 0.3m/1ft,** [K2.0006750](#)
- LBUS 0.5m/1.5ft,** [K2.0006751](#)
- LBUS 0.8m/2.5ft,** [K2.0006752](#)
- LBUS 1.5m/5ft,** [K2.0006753](#)
- LBUS 3m/10ft,** [K2.0006754](#)
- LBUS 6m/20ft,** [K2.0006755](#)
- LBUS 15m/49ft,** [K2.0006756](#)

- Cable LBUS to D-Tap 1.2m/4ft,** [K2.0006757](#)
- Cable LBUS to D-Tap 0.8m/2.5ft,** [K2.0006758](#)
- Cable LBUS to RS 0.8m/2.5ft,** [K2.0006759](#)
- Cable LBUS to XLR-4 0.8m/2.5ft,** [K2.0006760](#)

ALEXA Mini LF - Mechanical Accessories



Configuration Overview | 1.2.2 / 2024.01

ALEXA Mini LF



ALEXA Mini LF & Lens Mount Set, [K0.0024310](#)
Includes:
K1.0024074 1x ALEXA Mini LF camera body
K2.0018983 1x ARRI LPL Mount (LBUS)
K2.0016936 1x ARRI PL-to-LPL Adapter

Accessories



Vertical Adapter Set for ALEXA Mini LF [KK.0024136](#) Includes:
K2.0024165 1x Vertical Top Plate for ALEXA Mini LF
K2.0019442 1x Vertical Format Adapters (4x brackets)
K2.0019443 1x Vertical Viewfinder Adapter



15 mm Reduction Insert [K2.66255.0](#)



LBS-2 Handgrip Set without on/off [K0.0000465](#)



Camera and Accessory Case, [K2.0001241](#)



Wetsuit for ALEXA Mini, [K2.0010053](#)

ALEXA Mini LF Mechanical Accessories

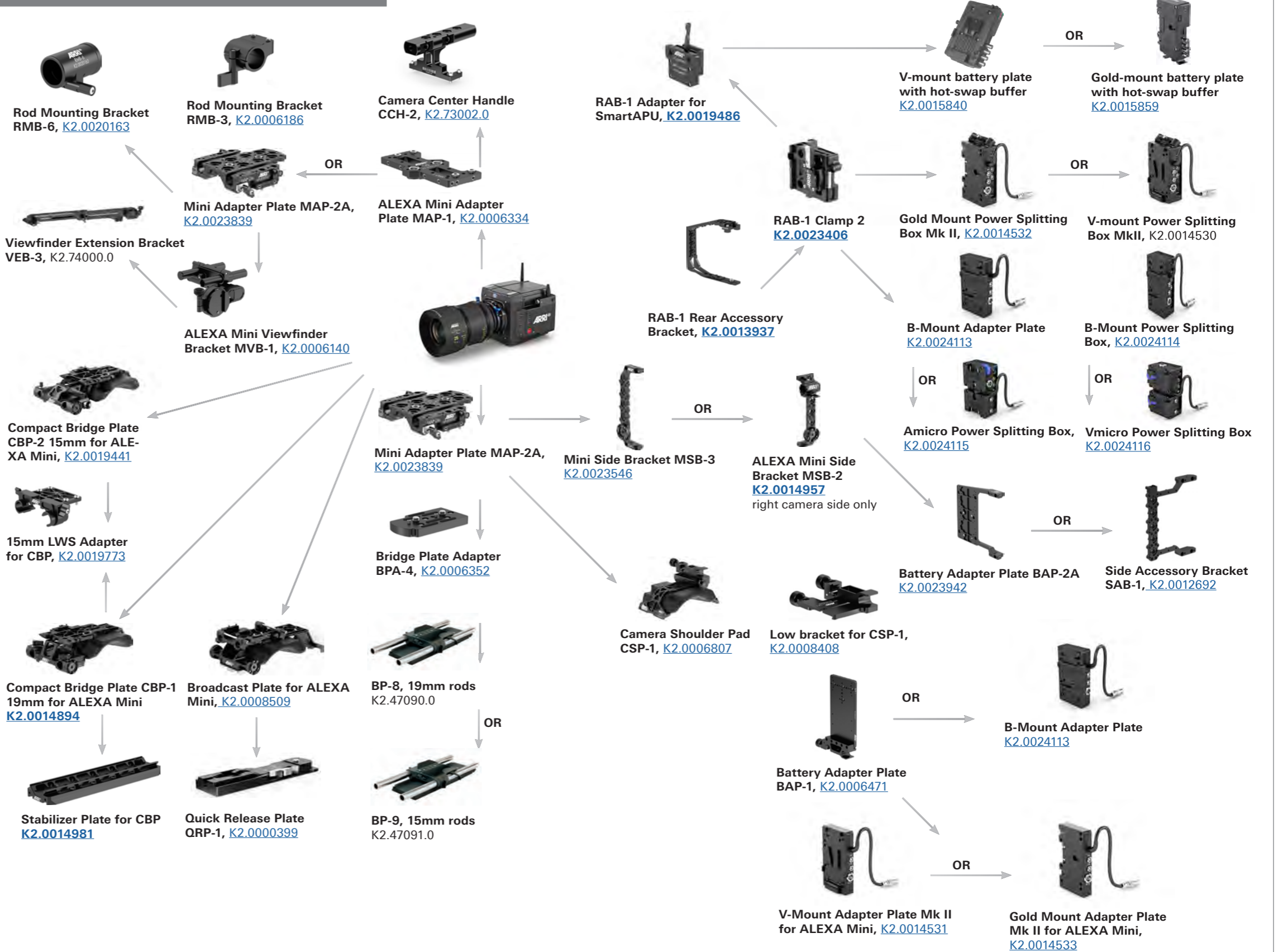

ALEXA Mini LF - compatible Mechanical Accessories for ALEXA 35



Configuration Overview | 1.2.3 / 2024.11

ALEXA Mini LF



ALEXA Mini LF & Lens Mount Set, [K0.0024310](#)

Includes:
 K1.0024074 1x ALEXA Mini LF camera body
 K2.0018983 1x ARRI LPL Mount (LBUS)
 K2.0016936 1x ARRI PL-to-LPL Adapter

Accessories



Vertical Adapter Set for ALEXA Mini LF

[KK.0024136](#) Includes:
 K2.0024165 1x Vertical Top Plate for ALEXA Mini LF
 K2.0019442 1x Vertical Format Adapters (4x brackets)
 K2.0019443 1x Vertical Viewfinder Adapter



15 mm Reduction Insert
[K2.66255.0](#)



LBS-2 Handgrip Set
 without on/off
 K0.0000465



Camera and Accessory
 Case, [K2.0001241](#)



Wetsuit for ALEXA Mini LF,
[K2.0036013](#)

ALEXA Mini LF & Mechanical Accessories for ALEXA 35

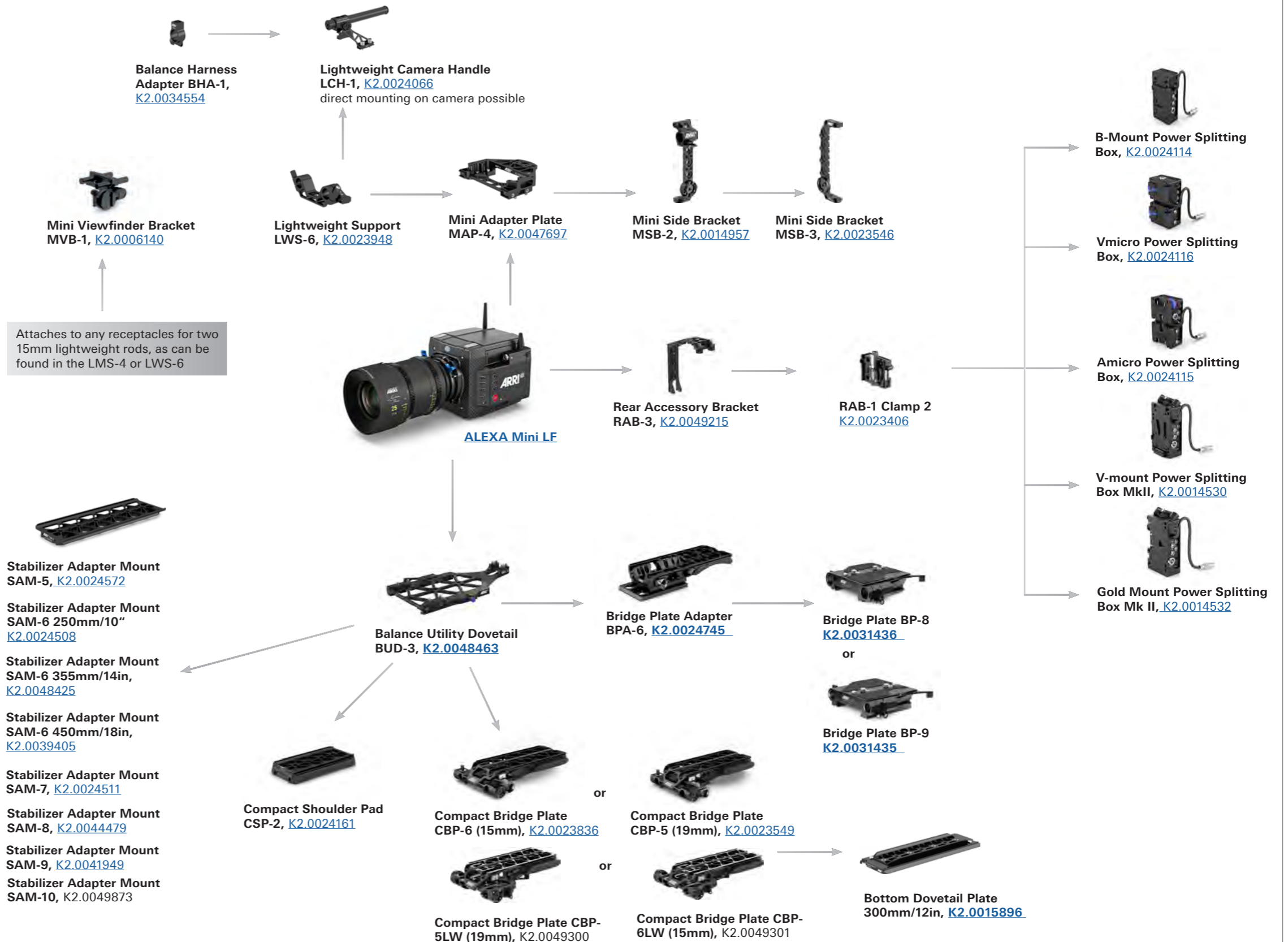

Configuration Overview | 1.3.0 / 2024.01

ALEXA LF Camera Sets



ALEXA Pro Camera Sets contain an ALEXA camera, sufficient media and a number of must-have accessories to get you up and shooting quickly.

ALEXA LF Basic Camera Set, [K0.0019228](#)

- Includes:
- K1.0014861 1x ALEXA LF camera body
 - K2.0008429 1x Codex SXR Capture Drive Adapter
 - K2.0006338 1x Codex SxS to SXR Adapter
 - K2.72018.0 1x Transcend SD card
 - K2.72008.0 1x ALEXA Electronic Viewfinder EVF-1
 - K2.74001.0 1x Viewfinder Mounting Bracket VMB-3
 - K2.72012.0 1x Viewfinder Cable Short (0.35m/1.2ft) KC 150-S
 - K2.72007.0 1x Center Camera Handle (CCH-1)
 - K2.0016936 1x ARRI PL-to-LPL Adapter
 - KK.0015010 1x Wireless Video Receiver WVR-1, Basic Set

ALEXA LF Pro Camera Set, 1 TB, [KB.72010.D](#)

- Includes:
- K0.0018830 1x ALEXA LF Basic Camera Set for Pro Set (1 TB)
 - K2.0006942 4x SXR Capture Drive 1TB
 - K2.0018790 1x ALEXA LPL LF FSND Filter Set, Full
 - K0.71030.0 1x ALEXA Bundle Accessory Set (EV/Plus/W/LF)

ALEXA LF Pro Camera Set, 2 TB, [KB.72020.D](#)

- Includes:
- K0.0018832 1x ALEXA LF Basic Camera Set for Pro Set (2 TB)
 - K2.0006157 4x Codex SXR Capture Drive 2TB
 - K2.0018790 1x ALEXA LPL LF FSND Filter Set, Full
 - K0.71030.0 1x ALEXA Bundle Accessory Set (EV/Plus/W/LF)

ALEXA LF Pro Camera Set (SxS Pro+ 256 GB), [KB.72030.D](#)

- Includes:
- K0.0018833 1x ALEXA LF Basic Camera Set for Pro Set, SxS Pro+ 256 GB
 - K2.0014951 5x Sony SxS PRO+ Card 256GB
 - K2.0018790 1x ALEXA LPL LF FSND Filter Set, Full
 - K0.71030.0 1x ALEXA Bundle Accessory Set (EV/Plus/W/LF)

ALEXA Bundle Accessory Set (EV/Plus/W/LF), [K0.71030.0](#)

- Includes:
- K2.72021.0 1x Cable ALEXA ETH/RJ45 (3.0m/9.8ft) KC 153-S
 - K2.72017.0 1x Leveling Block LB-1
 - K2.74000.0 1x Viewfinder Extension Bracket VEB-3
 - K2.66172.0 1x Bridge Plate Adapter BPA-2
 - K2.72031.0 1x ALEXA 12V Accessory Cable KC 154-SP-S
 - K2.72083.0 1x Shoulder Pad SP-4
 - K2.72013.0 1x Viewfinder Cable Medium (0.65m/2.1ft) KC 151-S
 - K2.72015.0 1x Handle Extension Block HEB-2

Note 1: Docks or on-board battery adapters are not included and can be ordered separately.
 Note 2: For use with LF FSND filters, the included FSND shim has to be installed to assure proper flange focal depth.

Viewfinder System



ALEXA Electronic Viewfinder EVF-2, K2.008397

- Viewfinder Cable
 35 cm, KC 150-S [K2.72012.0](#)
 65 cm, KC 151-S [K2.72013.0](#)



Viewfinder Extension Bracket VEB-3, [K2.74000.0](#)



Viewfinder Mounting Bracket, VMB-3 [K2.74001.0](#)



Heated Eycup, HE-7
 K2.0003898

LPL Mounts



ARRI LPL Mount ALEXA
[K2.0019072](#)



ARRI PL to LPL Adapter
[K2.0016936](#)

Media & Adapters



For details regarding Recording Medias please see Configuration Overview 1.9.0

Accessories



Remote Control Unit RCU-4, K2.72036.0 (incl. ALEXA Ethernet Remote Cable (2m/6.6ft) KC 157-S K2.72040.0)



Transvideo Starlite ARRI-WVS
[K2.0015243](#)



Bridge Plate Set BP-8, 19mm rods, K2.47090.0
 BP-9, 15mm rods, K2.47091.0
 BPA-2 needed



Bridge Plate Adapter BPA-2 (for BP-3, 5, 8 or 9)
[K2.66172.0](#)



Universal Adapter Plate UAP-1
[K2.72102.0](#)



Wedge Adapter, WA-1 (for Quick Release HD-Baseplate) [K2.72002.0](#) (spare)



Quick Release HD Baseplate
[K2.47796.0](#)



Shoulder Pad SP-4
[K2.72083.0](#)



Rod Mounting Bracket RMB-2, [KK.0005807](#)



Centre Camera Handle CCH-1, [K2.72007.0](#) (spare)



Side Camera Handle, SCH-1 [K2.72016.0](#)



Adjustable Center Grip tall, ACG-2, [K2.72022.0](#)



Handle Extension Block HEB-1 (without tape hook)
[K2.0001016](#)



Handle Extension Block HEB-2 (with tape hock)
[K2.72015.0](#)



ALEXA Handgrip Set
 K0.71033.0

Cables

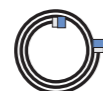

- Cable LCS (5p) - LBUS (0.8m/2.6ft) - [K2.0007318](#)
- ALEXA 12V Accessory Cable KC 154-SP-S, [K2.72031.0](#) (coiled)
- ALEXA Ethernet Cable 3m KC 153-S, [K2.72021.0](#)
- ALEXA EXT - EXT Cable 2m KC 155-S, [K2.72032.0](#)
- ALEXA Ethernet-Ethernet Cable 2M KC 156-S, [K2.72033.0](#)
- ALEXA Ethernet Remote Cable (1m/3.3ft) KC 158-S, [K2.72041.0](#)
- ALEXA Ethernet Remote Cable (2m/6.6ft) KC 157-S, [K2.72040.0](#)

- ALEXA Ethernet Extension Cable (15m/50ft) for RCU-4 KC 159-S, [K2.72043.0](#) (up to three KC-159-S for total length of 47m/154ft with [K2.72040.0](#) or 46m/151ft with [K2.72041.0](#))

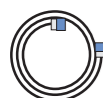

- Power Cable KC-20 [K2.41966.0](#)
- KC-29 [K2.44693.0](#) (coiled)

Power Supply & Battery Adapter



Battery Adapter Back Hi-Load BAB-HV V-mount for ALEXA LF
[K2.0019453](#)



Battery Adapter Back Hi-Load BAB-HG Gold-Mount for ALEXA LF,
[K2.0019456](#)



Hawk-Woods RP-CFA1 Battery Adapter
[K2.0019383](#)



B-Mount Adapter ALEXA BMM-24-ALEX
[K2.0038613](#)



ARRI Power Supply Light 24V
[K2.0034493](#)



Camera Handgrip Right, [K2.45886.0](#)



Extension for Handgrip
[K2.47136.0](#)



Leveling Block LB-1, [K2.72017.0](#)



Ultrasonic Distance Measure UDM-1 Set [K0.60055.0](#)
 Cable UDM-ALEXA K2.65261.0



Ext Distribution Box EDB-1
 K2.72038.0



ALEXA LF/ALEXA SXT W Case
[K2.0015098](#)

Configuration Overview | 1.4.0 / 2024.01

AMIRA Camera Sets

AMIRA Camera Set Eco: [K0.0001090](#)

Features include HD 1080i & 1080p recording at 0.75 - 100 fps to QuickTime ProRes 422 LT or 422 files with Rec 709 encoding; 3 Looks with image parameters for knee, gamma, saturation & other adjustable in the camera, focus and exposure control tools; Intervalometer; Multicam interface; S16 lens mode.

AMIRA Camera Set with Advanced License: [K0.0001091](#)

Advanced license key provides HD 1080i & 1080p recording at 0.75 - 200 fps to QuickTime ProRes 422 LT, 422, or 422 HQ files with Rec 709 or Log C encoding; Complete CDL and video look functions; import looks without 3D LUT; focus and exposure control tools; dynamic auto tracking white balance; remote control; Bluetooth audio monitoring; Features additional to basic AMIRA set: 100 - 200 fps recording; ProRes 422 HQ codec; Log C encoding; more look functions including import/export and ASC CDL in-camera grading; dynamic auto tracking white balance; remote control; Bluetooth audio monitoring; pre-recording function.

AMIRA Camera Set with Premium License - All Included: [K0.0014798](#)

Premium license key provides HD 1080i & 1080p or 2K (2048 x 1152) recording at 0.75 - 200 fps to QuickTime ProRes 422 LT, 422, 422 HQ, or 4444 files with Rec 709 or Log C encoding; Complete CDL and video look functions; import looks with or without custom 3D LUTs; focus and exposure control tools; dynamic auto tracking white balance; remote control; Bluetooth audio monitoring; Pre-recording function; Intervalometer; Multicam interface; S16 lens mode. Features additional to Advanced AMIRA set: 2K (2048 x 1152) recording; ProRes 4444 codec, Support for Looks including a custom 3D LUT.

includes new:

10.0014641 1x ARRI AMIRA Look Library License

10.0003723 1x AMIRA UHD License Key

K2.75004.0 1x AMIRA Viewfinder MVF-1

K1.71700.0 1x AMIRA camera body, camera handle, viewfinder mount, viewfinder cables, USB stick

Note: CFast 2.0 cards, lens mount, battery adapter and camera base mount are not included need to be ordered separately or as part of an accessories bundle and/or lens mount bundle.

available in the ARRI license shop: [10.0003723](#) - 4K UHD support



Mechanical Accessories



Viewfinder Attachment Bracket VAB-1, [K2.0001297](#)



Viewfinder Adapter VFA-2, [K2.0001222](#)



Viewfinder Extension Bracket VEB-3, [K2.74000.0](#)



Shoulder Belt Adapters SBA-1, [K2.0001223](#)



Side Accessory Bracket SAB-2, [K2.0014088](#)



AMIRA Microphone Holder Bracket MHB-2, [K2.75005.0](#)



Heated Eycup, HE-7
K2.0003898



GPB-1 Mounting Bracket,
K2.0008533
(clamp console CLM-5/c-force
K2.0006176 NOT incl.)



Handgrip Set right
K0.0001249



Rod Mounting Bracket RMB-4, [K2.0013007](#)



Camrader Raincover for AMIRA, [K2.0004025](#)



AMIRA Camera Case, [K2.0001239](#)



Accessories/
Camera Case,
[K2.0001241](#)



AMIRA Camera Bag Portabrace, [K2.0001240](#)

AMIRA Camera Support



Wedge Plate Adapter WPA-1, [K2.75000.0](#)



Bridge Plate Adapter BPA-3, [K2.75006.0](#)
(compatible with BP-8)



Compact Bridge Plate CBP-3 19mm for AMIRA, [K2.0019580](#)



Compact Bridge Plate CBP-4 15mm for AMIRA, [K2.0019582](#)



BP-8, 19mm rods
[K2.47090.0](#)



BP-9, 15mm rods
[K2.47091.0](#)



Quick Release Plate QRP-1, [K2.0000399](#)



Universal Adapter Plate UAP-2 Set, [K0.0001280](#)



Universal Adapter Plate UAP-2, [K2.0001221](#)

AMIRA Power Option



B-Mount Adapter BMM-AMIRA
[K2.0038614](#)



Gold Mount Battery Adapter
[K2.75001.0](#)



V-lock Battery Adapter
[K2.75002.0](#)



Ambient Power slot for AMIRA (for Gold Mount AB batteries), [K2.0008762](#)



Ambient Power slot for AMIRA (for V-lock batteries), [K2.0008763](#)



ARRI Power Supply Light 24V, [K2.0034493](#)

Lens Mounts and Adapter



ARRI LPL Mount (LBUS)
[K2.0018983](#)



ARRI PL to LPL Adapter
[K2.0016936](#)



Titanium PL LDS mount with LBUS connector, [K2.0003216](#)
LBUS connector not working on Amira



PL LDS Lens Mount
[K2.0001107](#)



B4 Lens Mount
[K2.0001237](#)



EF Lens Mount
[K2.0001103](#)



PL to B4 Lens Adapter
[K2.0001238](#)

Cables

AMIRA Power Cable Straight KC-50 (2m, 6.6 feet), [K2.75007.0](#)

AMIRA Viewfinder Cable Short (0.5m, 1.64 feet), [K2.0007750](#)

AMIRA Viewfinder Cable Medium (1m, 3,28 feet), [K2.0007751](#)

AMIRA Viewfinder Cable Long (3m, 9,84 feet), [K2.0009003](#)

AMIRA 12/20pin Hirose ENG Lense Cable Short (0.25m, 0.8 feet), [K2.0001268](#)



AMIRA Audio XLR Cable

5pin Male to 5pin Female Short (0.4m, 1.3 feet), [K2.0001269](#)

5pin Male to 3pin Female Short (0.4m, 1.3 feet), [K2.0001270](#)

3pin Male to 3pin Female Short (0.4m, 1.3 feet), [K2.0001271](#)

Electronic Accessories



Camera Control Panel CCP-1 for ALEXA Mini, K0.00010096 (cable set and L-bracket incl.)



General Purpose IO Box GPB-1, [K2.0007642](#)
(cable K2.000773)



AMIRA Onboard Microphone Set
[K2.0004024](#)

AMIRA Accessory Bundles

Accessory Bundle 1: [K0.0001244](#)

includes:
[K2.0001223](#) 1x Shoulder Belt Adapters
[K2.0001240](#) 1x AMIRA Camera Bag Portabrace
[K2.75005.0](#) 1x Micro. Holder Bracket MHB-2
[K2.0024245](#) 1x Angelbird CFast 2.0 Card Reader
[K2.0015640](#) 2x SanDisk CFast2.0 card 256GB
[K2.75000.0](#) 1x Wedge Plate Adapter WPA-1

Accessory Bundle 2: [K0.0001245](#)

Includes:
[K2.75000.0](#) 1x Wedge Plate Adapter WPA-1
[K2.0016648](#) 2x SanDisk CFast2.0 card 512GB
[K2.0024245](#) 1x Angelbird CFast 2.0 Card Reader
[K2.75005.0](#) 1x Microphone Holder Bracket MHB-2
[K2.0001223](#) 1x Shoulder Belt Adapters
[K2.0000399](#) 1x QRP-1-Baseplate
[K2.0001240](#) 1x AMIRA Camera Bag Portabrace

Accessory Bundle 3: [K0.0001246](#)

Includes:
[K2.75000.0](#) 1x Wedge Plate Adapter WPA-1
[K2.75006.0](#) 1x Bridge Plate Adapter BPA-3
[K2.0016648](#) 2x SanDisk CFast2.0 card 512GB
[K2.0024245](#) 1x Angelbird CFast 2.0 Card Reader
[K2.75005.0](#) 1x Microphone Holder Bracket MHB-2
[K2.0001221](#) 1x Universal Adapter Plate UAP-2
[K2.0001297](#) 1x Viewfinder Attachment Bracket VAB-1
[K2.72007.0](#) 1x Center Camera Handle CCH-1
[K2.0001222](#) 1x Viewfinder Adapter VFA-2
[K2.0000399](#) 1x QRP-1-Baseplate
[K2.0001239](#) 1x AMIRA Camera Case

Lens Mount Bundle: K0.0001247

Includes:
[K2.0001103](#) 1x EF lens mount
[K2.0001237](#) 1x B4 Lens Mount
[K2.0001107](#) 1x PL LDS Lens Mount

Configuration Overview | 1.4.1 / 2024.01

Amira, License & Media

AMIRA Camera Set Eco: [K0.0001090](#)
 AMIRA Camera Set Advanced: [K0.0001091](#)
 AMIRA Camera Set Premium: [K0.0014798](#)

AMIRA UHD License Key
[10.0003723](#)

ARRI AMIRA Look Library License
[10.0014641](#)

Extended Warranty for AMIRA
 10.0006375

For Recording Media please see Config 1.9.0

Electronic Accessories



Camera Control Panel CCP-1 Set for AMIRA, [K0.0010097](#) (cable set and L-bracket incl.)



AMIRA Onboard Microphone Set, [K2.0004024](#)



General Purpose IO Box GPB-1, [K2.0007642](#) (cable K2.0007736 incl.)



GPB-1 Mounting Bracket, K2.0008533 (clamp console CLM-5/c-force K2.0006176 NOT incl.)

Accessories



AMIRA Camera Case, [K2.0001239](#)



Camera and Accessories Case [K2.0001241](#)



AMIRA Camera Bag Portabrace, [K2.0001240](#)



AMIRA Raincover [K2.0004025](#)



AMIRA Power Cable Straight KC-50 (2m, 6.6 feet), [K2.75007.0](#)

Amira Mechanical Accessories

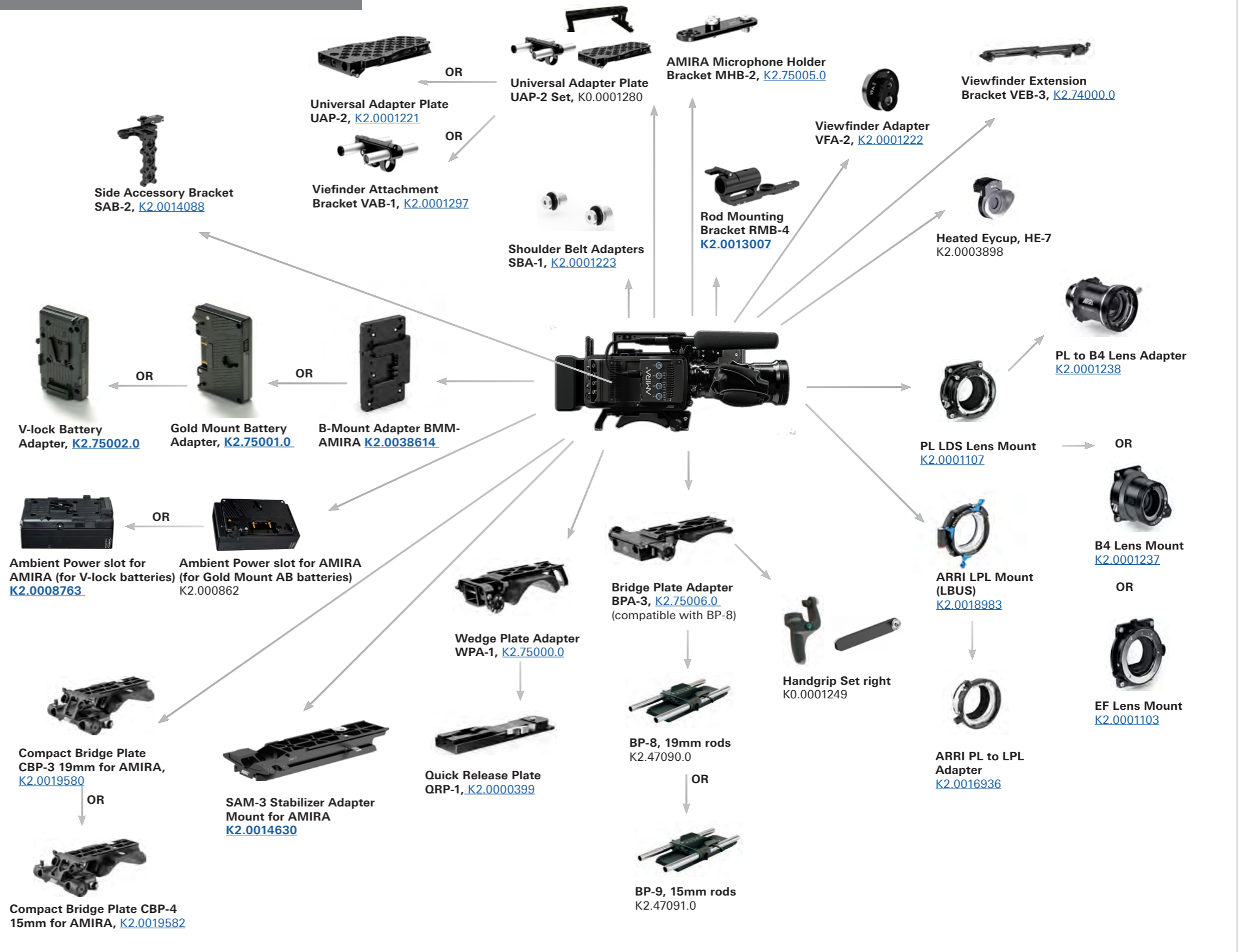

Configuration Overview | 1.5.0 / 2024.07

ALEXA Mini*



ALEXA Mini Body, [K0.0014799*](#)

includes:
K1.0003873 1x ALEXA Mini Body*
10.0014640 1x ALEXA Mini ARRI Look Library License Key

ALEXA Mini Body with 4:3 and ARRIRAW, [K0.0014797*](#)

includes:
K1.0003873 1x ALEXA Mini Body*
10.0008148 1x ALEXA Mini ARRIRAW License Key
10.0008147 1x ALEXA Mini 4:3 License Key
10.0014640 1x ALEXA Mini ARRI Look Library License Key

ALEXA Mini ARRIRAW License Key

[10.0008148](#)

ALEXA Mini 4:3 License Key

[10.0008147](#)

ALEXA Mini ARRI Look Library License Key

10.0014640

Extended Warranty for ALEXA Mini

[10.0007223](#)

* discontinued items
no stock available
anymore

ALEXA Mini Viewfinder



ALEXA Mini Viewfinder
MVF-1, [K2.0005861](#)
(cable K2.0008135 0,75m incl.)

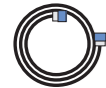

ALEXA Mini Viewfinder Cable 0.5m, [K2.0009367](#)
ALEXA Mini Viewfinder Cable 0.75m, [K2.0008135](#)
ALEXA Mini Viewfinder Cable 1.5m, [K2.0009169](#)

Lens Mounts and Adapter



ARRI LPL Mount
(LBUS)
[K2.0018983](#)

ARRI PL-to-
LPL Adapter
[K2.0016936](#)

ARRI EF
Mount
(LBUS)
[K2.0019965](#)

Titanium PL LDS
mount with LBUS
[K2.0003216](#)



PL LDS Lens
Mount
[K2.0001107](#)



B4 Lens
Mount
[K2.0001237](#)



EF Lens
Mount
[K2.0001103](#)



PL to B4 Lens
Adapter
[K2.0001238](#)

ALEXA Mini Viewfinder



Camera Control Panel CCP-1
for ALEXA Mini, K0.00010096
(cable set and L-bracket incl.)



ALEXA Mini to CCP-1 cable set, K0.0010044
ALEXA Mini to CCP-1 cable 0,5m (19"), K2.0009337
ALEXA Mini to CCP-1 cable 1,0m (29"), K2.0009336
ALEXA Mini to CCP-1 cable 1,5m (59"), K2.0009181

Monitor



Transvideo Starlite
HD5-ARRI 5" OLED Monitor [K2.0006960](#)



Starlite HD5 ARRI Ext cable angled, [K2.0008662](#)
Starlite HD5 ARRI Ext cable straight, [K2.0008663](#)



Transvideo Starlite ARRI-WVS
[K2.0015243](#)

General Purpose IO Box



General Purpose IO Box
GPB-1, [K2.0007642](#) (cable incl.)



GPB-1 Mounting Bracket,
K2.0008533

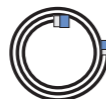

Cable ALEXA Mini/AMIRA EXT to GPB-1,
[K2.0007736](#)

ALEXA Mini Media and Readers



For details regarding
Recording Medias please see
Configuration Overview 1.9.0

EXT SYNC



EXT Distribution Box 2
(EDB-2) for ALEXA Mini [K2.0013145](#)



ALEXA Mini EXT to EXT cable 1,5m (59 inch)
[K2.0009051](#)

Splitting Boxes and Adapter Plates



V-mount Power Splitting
Box MkII, [K2.0014530](#)



V-Mount Adapter Plate Mk II
for ALEXA Mini, [K2.0014531](#)



Gold Mount Power Splitting
Box Mk II, [K2.0014532](#)



Gold Mount Adapter Plate
Mk II for ALEXA Mini,
[K2.0014533](#)



V-mount battery plate with
hot-swap buffer, [K2.0015840](#)



Gold-mount battery plate with
hot-swap buffer, [K2.0015859](#)

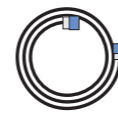

Power Cable Smart APU to ALEXA Mini
6' (1.85m), K2.0015861
Power Cable Smart APU to ALEXA Mini
2.6' (0.80m), K2.0015862
Power Cable Smart APU to ALEXA Mini
(0.25m), K2.0015863

no pic available yet

Top support rod bracket 15mm LWS
K2.0015865

Cables & Power Supply

ARRI Power Supply Light 24V K2.0034493

Power Cable Straight KC-50 (2m, 6.6 feet), [K2.75007.0](#)

Ethernet Cable 3m KC 153-S, [K2.72021.0](#)

ALEXA Mini Audio connector with cable, [K2.0006171](#)

ALEXA Mini EXT to LCS, [K2.0007624](#)

ALEXA Mini EXT to EXT cable 1,5m (59 inch), [K2.0009051](#)

EXT-RS Adapter, [K2.0006170](#)

Electronic Control System



cforce plus (Basic Set)
[K0.0010103](#)



cforce mini (Basic Set)
[K2.0006355](#)



Master Grip Left Wheel
MLW-1, [K2.0009363](#)



Master Grip Right Rocker
MRR-1, [K2.0009493](#)



Hi-5 SX Body Kit
KK.0051704



Operator Control Unit OCU-1
Basic Set, [K2.0020002](#)



Ultrasonic Distance
Measure UDM-1 Set
[K0.60055.0](#)



LCUBE CUB-1, [K0.0010104](#)
LBUS cables need
to be ordered separatley

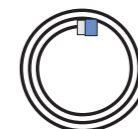

LBUS 0.2m/8", [K2.0006749](#)
LBUS 0.3m/1ft, [K2.0006750](#)
LBUS 0.5m/1.5ft, [K2.0006751](#)
LBUS 0.8m/2.5ft, [K2.0006752](#)
LBUS 1.5m/5ft, [K2.0006753](#)
LBUS 3m/10ft, [K2.0006754](#)
LBUS 6m/20ft, [K2.0006755](#)
LBUS 15m/49ft, [K2.0006756](#)

Cable LBUS to D-Tap 1.2m/4ft, [K2.0006757](#)
Cable LBUS to D-Tap 0.8m/2.5ft, [K2.0006758](#)
Cable LBUS to RS 0.8m/2.5ft, [K2.0006759](#)
Cable LBUS to XLR-4 0.8m/2.5ft, [K2.0006760](#)

ALEXA Mini* - Mechanical Accessories



Configuration Overview | 1.5.1 / 2024.01

ALEXA Mini



ALEXA Mini Body, [K0.0014799*](#)

includes:
K1.0003873 1x ALEXA Mini Body*
10.0014640 1x ALEXA Mini ARRI Look Library License Key

ALEXA Mini Body with 4:3 and ARRIRAW, [K0.0014797*](#)

includes:
K1.0003873 1x ALEXA Mini Body*
10.0008148 1x ALEXA Mini ARRIRAW License Key
10.0008147 1x ALEXA Mini 4:3 License Key
10.0014640 1x ALEXA Mini ARRI Look Library License Key

ALEXA Mini ARRIRAW License Key

10.0008148

ALEXA Mini 4:3 License Key

10.0008147

ALEXA Mini ARRI Look Library License Key

[10.0014640](#)

Extended Warranty for ALEXA Mini

10.0006955

Accessories



Vertical Format Adapter Set for ALEXA Mini, [KK.0019829](#)

includes:
K2.0019443 1x Vertical Viewfinder Adapter for ALEXA Mini
K2.0019442 1x Vertical Format Adapter for ALEXA Mini



15 mm Reduction Insert
[K2.66255.0](#)

LBS-2 Handgrip Set
without on/off
K0.0000465



Camera and Accessory
Case, [K2.0001241](#)

Wetsuit for ALEXA Mini,
[K2.0010053](#)

ALEXA Mini Mechanical Accessories

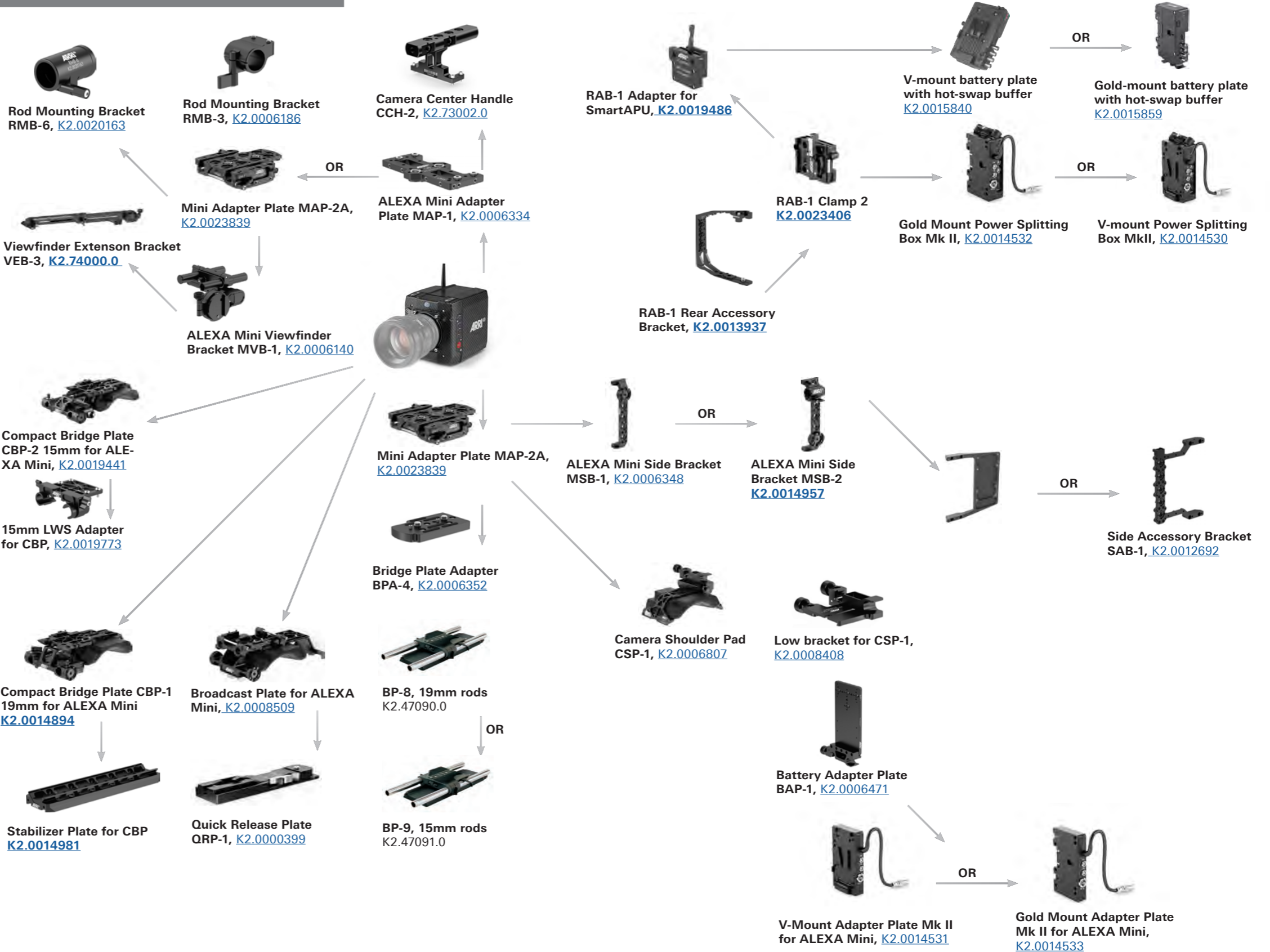

Recording Media - CODEX Compact & Capture Drives



Configuration Overview | 1.6.0 / 2025.10

CODEX Compact Drive



ALEXA 35



ALEXA Mini LF



CODEX Compact Drive 2TB ***
[K2.0023447](#)
CODEX Compact Drive set 3x2TB
[K0.0040251](#)
CODEX Compact Drive set 6x2TB
[KK.0040353](#)



CODEX Compact Drive Express 1TB,
[K2.0053843](#)



CODEX Compact Drive 1TB **
[K2.0024130](#)
CODEX Compact Drive set 3x1TB
[K0.0024596](#)
CODEX Compact Drive set 6x1TB
[KK.0024370](#)
CODEX Compact Drive set 12x1TB
[K0.0048298](#)



CODEX Compact Drive Reader (USB-C)
[K2.0024134](#) (Codex# CDX.0001005)



CODEX Compact Drive Dock (TB3)
[K2.0034320](#) (Codex# CDX.0001007)



CODEX Compact Drive Adapter
[K2.0024131](#) (Codex# CDX.0001009)



CODEX SXR Capture Drive Dock (TB3)
[K2.0019728](#) (CODEX# CDX-75013-2)

** Most Compact Drive 1TB need a firmware update, which can be applied by ALEXA 35 in-camera. Updated drives will also be supported starting with Mini LF SUP 7.1.1.
 *** Mini LF supports Compact Drive 2TB starting with Mini LF SUP 7.1.1

CODEX Capture Drive



ALEXA LF



ALEXA SXT W

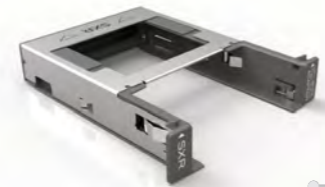

CODEX SXR Capture Drive Adapter
[K2.0008429](#) (Codex# CDX-37097)



CODEX SXR Capture Drive 1TB
[K2.0006942](#) (CODEX# CDX-37019/18)

CODEX SXR Capture Drive set 4x1TB
[K0.0006946](#)



CODEX SXR Capture Drive 2TB
[K2.0006157](#) (CODEX# CDX-37021/20)

CODEX SXR Capture Drive set 4x2TB
[K0.0015012](#)



CODEX SXR Capture Drive Dock (TB3)
[K2.0019728](#) (CODEX# CDX-75013-2)

Recording Media - CFast 2.0 & SxS PRO+ Cards



Configuration Overview | 1.6.1 / 2025.10

CFast 2.0 Cards



ALEXA Mini



Amira



ARRI Angelbird CFast2.0 card 256GB*
K2.0021432 (Angelbird# AVproAR256)



SanDisk CFast2.0 card 128GB
K2.0003623

SanDisk CFast2.0 card set 3x128GB
K0.0019005



SanDisk CFast2.0 card 256GB
K2.0015640

SanDisk CFast2.0 card set 3x256GB
K0.0019006



ARRI SanDisk CFast2.0 card 512GB
K2.0016648

ARRI SanDisk CFast2.0 card set 3x512GB
K0.0019007



Angelbird CFast 2.0 Card Reader (USB-C)*
K2.0024245



* Angelbird Products:

purchase and sales directly via
sales@angelbird.com
www.angelbird.com
no further distribution via ARRI

SxS PRO+ Cards



ALEXA LF



ALEXA SXT W



CODEX SxS to SXR adapter
K2.0006338 (CODEX# CDX-37098)



Sony SxS PRO+ card 256GB
K2.0014951

Sony SxS PRO+ card set 3x256GB
K0.0015004

Available from various resellers



Sony SBAC-UT100
or other SxS card reader

End of Support

The last version of SxS PRO+ cards (E-Series) unfortunately also is the final chapter for ARRI and SxS. With SxS PRO X, Sony introduced a new generation of these cards, which brought some technical requirements that cannot be met in our range of ALEXA cameras.

Configuration Overview | 2.0.0 / 2025.08

Model	ALEXA 35 Live SUP 4.1.0 	ALEXA 35 Xtreme with Premium License SUP 5.0.0 	
Frame Rate	0.75 - 60fps	0 - 660 fps	
Recording Modes	Standard	Standard Pre-Recording	
Recording Codecs	Apple ProRes	Apple ProRes ARRICORE ARRIRAW	
Sensor Modes	4K 16:9 4K 2:1 3.8K 16:9 HD 16:9	4.6K 3.2 Open Gate 4.6K 16:9 4K 16:9 3.8K 16:9	3.8K 2.39:1 3.3K 6:5 2K 16:9 S16 HD 16:9 S16
Licenses	Multicam License	Premium License	
Anamorphic Desqueeze	YES	Recording Monitoring	NO YES
Color Management	ARRI	ARRI Custom	

ALEXA 35 Live - Licenses Upgrade Scenario

To upgrade an ALEXA 35 Live to full ALEXA 35 features, a Cine Plus License has to be purchased. The ALEXA 35 Live then has all the features of the ALEXA 35 and of the ALEXA 35 Live.

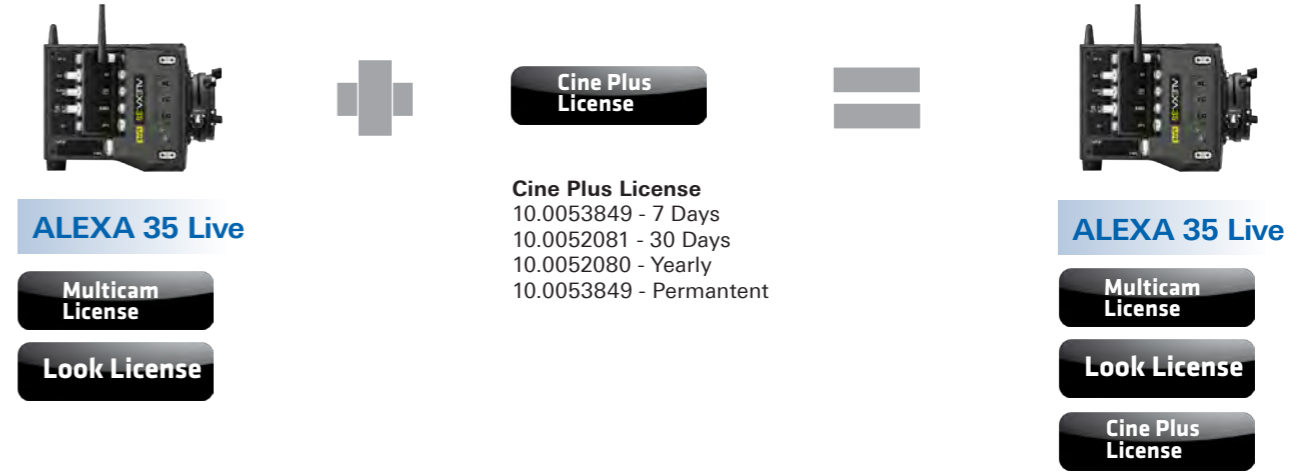

ALEXA 35/ALEXA 35 Xtreme - Licenses Upgrade Scenario 1

As long as the FCA is attached to any ALEXA 35/ALEXA 35 Xtreme, it enables the Multicam license features in that camera. The camera then has all the features of the ALEXA 35/ALEXA 35 Xtreme and of the ALEXA 35 Live.



ALEXA 35/ALEXA 35 Xtreme - Licenses Upgrade Scenario 2

To use an ALEXA 35/ALEXA 35 Xtreme in a multicam production without an FCA (for instance for ARTEMIS, TRINITY or Spidercam), a Multicam license has to be purchased. Each ALEXA 35 - Multicam Extension Set includes a 40% discount voucher for a permanent Multicam license.

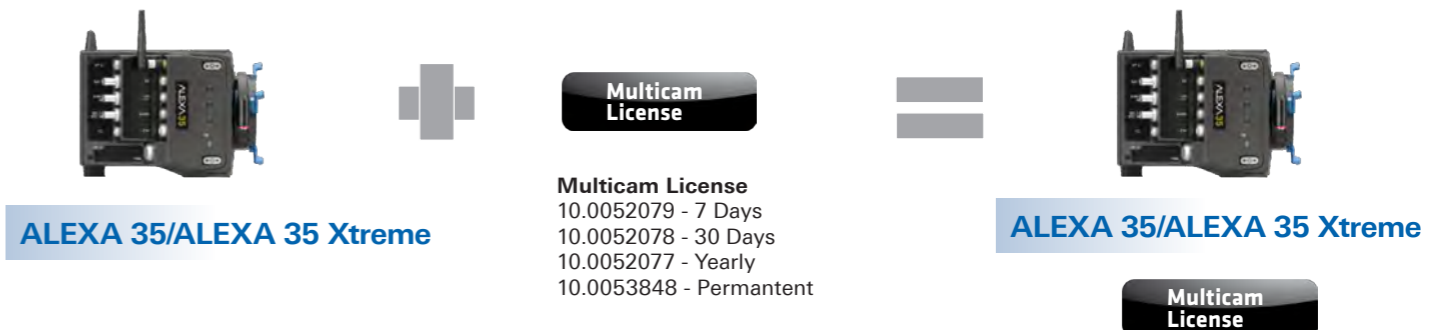

ALEXA 35 Live - Feature Licenses



Configuration Overview | 2.0.1 / 2025.01

	pre-installed licenses when ordering an ALEXA 35 Live	Licences for individual purchase				
		Cine Plus	120 fps	ARRIRAW	Open Gate / Anamorphic	Pre-record
Permanent	pre-installed	10.0053849	10.0052056	10.0052061	10.0052065	10.0052069
Temporary - 1 Year	-	10.0052080	10.0052058	10.0052062	10.0052066	10.0052070
Temporary - 30 days	-	10.0052081	10.0052059	10.0052063	10.0052067	10.0052071
Temporary - 7 days	-	10.0052082	10.0052060	10.0052064	10.0052068	10.0052072
0.75 - 60 fps	✓					
ProRes Recording	✓					
Enhanced Sensitivity	✓					
ARRI Color Management (in-camera SDR & HDR DRTs)	✓					
Basic 16:9 & 2:1 Spherical Recording Formats	✓					
ARRI Look File (CDL & 3D LUTs)	✓					
60 - 120 fps (for selected formats)		✓	✓			
ARRIRAW		✓		✓		
Open Gate Recording Formats		✓			✓	
Anamorphic Recording Formats		✓			✓	
Anamorphic De-squeeze in Monitor Path		✓			✓	
Pre-recording		✓				✓
ARRI Textures	✓					
Look Library	✓					
Custom Color Management	✓					
Live painting	✓					
Multicam Looks	✓					
Multicam Textures	✓					
Remote Tally	✓					

ALEXA 35 Live - Multicam System - Sets Overview



Configuration Overview | 2.0.2 / 2026.04

ALEXA 35 Live - Multicam System Sets



ALEXA 35 Live - Entry System (XR), K0.0056174
includes:
KK.0056171 1x ALEXA 35 Live Camera Body (XR)
K2.0042652 1x ARRI PL Mount (Hirose)
K2.0034180 1x Balance Utility Dovetail BUD-1
K2.0051089 1x LPS-1 Fiber Camera Adapter FCA-1
K2.0051088 1x LPS-1 Fiber Base Station FBS-1
K2.0051067 1x Camera to FCA Ethernet Cable



ALEXA 35 Live - Standard System (XR), K0.0056176
includes:
KK.0056171 1x ALEXA 35 Live Camera Body (XR)
K2.0042652 1x ARRI PL Mount (Hirose)
K2.0034180 1x Balance Utility Dovetail BUD-1
K2.0051089 1x LPS-1 Fiber Camera Adapter FCA-1
K2.0051088 1x LPS-1 Fiber Base Station FBS-1
K2.0051067 1x Camera to FCA Ethernet Cable
KK.0055173 1x ALEXA 35 Multicam Support Set 2



ALEXA 35 Live - Pro System (XR), K0.0056175
includes:
KK.0056171 1x ALEXA 35 Live Camera Body (XR)
K2.0042652 1x ARRI PL Mount (Hirose)
K2.0034180 1x Balance Utility Dovetail BUD-1
K2.0051089 1x LPS-1 Fiber Camera Adapter FCA-1
K2.0051088 1x LPS-1 Fiber Base Station FBS-1
K2.0051067 1x Camera to FCA Ethernet Cable
KK.0055173 1x ALEXA 35 Multicam Support Set 2
K2.0013042 1x Cable LBUS (angled) - LBUS (straight) (0.35m/1.15ft)
K2.0050774 1x Large Lens Adapter LLA-1
K2.0055339 1x LLA-1/BUD Slider Plate
K2.0051099 1x LLA-1 Control Module
K2.0050125 1x Cable Hirose to Box Lens
K2.0050793 1x Case for LLA-1

ALEXA 35 - Multicam Extension Sets

For owners of existing ALEXA 35 cameras. PL Mount (Hirose) recommended.

As long as the FCA is attached to any ALEXA 35 or ALEXA 35 Xtreme, it enables the Multicam license features in that camera. The ALEXA 35 or ALEXA 35 Xtreme then has all the features of the ALEXA 35 or ALEXA 35 Xtreme and of the ALEXA 35 Live. To use an ALEXA 35 or ALEXA 35 Xtreme in a multicam production without an FCA (for instance for ARTEMIS, TRINITY or Spidercam), a Multicam license has to be purchased. Each ALEXA 35 - Multicam Extension Set includes a 40% discount voucher for a Multicam license.



ALEXA 35 - Multicam Extension Set Entry, K0.0051278
includes:
KK.0051644 1x LPS-1 Fiber Camera Adapter FCA-1 4ExtSet (enables Multicam licence-features)
K2.0051088 1x LPS-1 Fiber Base Station FBS-1
K2.0051067 1x Camera to FCA Ethernet Cable



ALEXA 35 - Multicam Extension Set Std., K0.0056227
includes:
KK.0051644 1x LPS-1 Fiber Camera Adapter FCA-1 4ExtSet
K2.0051088 1x LPS-1 Fiber Base Station FBS-1
K2.0051067 1x Camera to FCA Ethernet Cable
KK.0055173 1x ALEXA 35 Multicam Support Set 2



ALEXA 35 - Multicam Extension Set Pro, K0.0056226
includes:
KK.0051644 1x LPS-1 Fiber Camera Adapter FCA-1 4ExtSet
K2.0051088 1x LPS-1 Fiber Base Station FBS-1
K2.0051067 1x Camera to FCA Ethernet Cable
KK.0055173 1x ALEXA 35 Multicam Support Set 2
K2.0013042 1x Cable LBUS (angled) - LBUS (straight) (0.35m/1.15ft)
K2.0050774 1x Large Lens Adapter LLA-1
K2.0055339 1x LLA-1/BUD Slider Plate
K2.0051099 1x LLA-1 Control Module
K2.0050125 1x Cable Hirose to Box Lens
K2.0050793 1x Case for LLA-1



Multicam Accessory Sets

ALEXA 35 Multicam Support Set, KK.0051232
includes:
K2.0049959 1x Touchdown Base Plate TBP-1
K2.0049960 1x Touchdown Receiver Plate TRP-1
K2.0050634 1x Live Production Handle LPH-1

Operator Set, KK.0051696
includes:
K2.0049425 1x Top Operator Grip TOG-1
K2.0049422 1x Top Operator Plate TOP-1
K2.0049959 1x Touchdown Base Plate TBP-1
K2.0049960 1x Touchdown Receiver Plate TRP-1

Large Lens Adapter LLA-1 Set Entry, KK.0056559
Inclusive:
K2.0050774 1x Large Lens Adapter LLA-1
K2.0055339 1x LLA-1/BUD Slider Plate
K2.0050125 1x Cable Hirose to Box Lens

ALEXA 35 Live RAB-4 V-Mount Set, KK.0055419
includes:
K2.0055159 1x Rear Accessory Bracket RAB-4
K2.0048324 1x NATO Rail Clamp NRC-2

Large Lens Adapter LLA-1 Set Standard, KK.0056558
inclusive:
K2.0050774 1x Large Lens Adapter LLA-1
K2.0055339 1x LLA-1/BUD Slider Plate
K2.0051099 1x LLA-1 Control Module
K2.0013042 1x Cable LBUS (angled) - LBUS (straight) (0.35m/1.15ft)
K2.0050125 1x Cable Hirose to Box Lens
K2.0050817 1x camRade rainCover OB/EFP Large
K2.0050793 1x Case for LLA-1

Monitor Sets for Live Productions

CCM-1 for Live Production Set, KK.0051229
includes:
K2.0048523 1x CCM-1 with Foldable Sunhood, Screen Protector
K2.0051078 1x Monitor Yoke Support MYS-1L (for CCM-1)
K2.0023943 2x Cable VF (0.5m/1.5ft)
K2.0001637 1x Cable RS - RS/PWR IN (0.5m/1.6ft)

Live Production Monitor LPM-1 Basic Set, KK.0055403, includes:
K2.0055129 1x Live Production Monitor LPM-1 Unit
K2.0054648 1x LPM-1 Short Foldable Sunhood
K2.0054647 1x LPM-1 Front Handle

Live Production Monitor LPM-1 Pro Set, KK.0054652
includes:
KK.0055403 1x Live Production Monitor LPM-1 Basic Set
K2.0054147 1x Monitor Yoke Support MYS-2 (for LPM-1)
K2.0023943 1x Cable VF (0.5m/1.5ft)
K2.0001637 1x Cable RS - RS/PWR IN (0.5m/1.6ft)

ALEXA 35 Live - Multicam System- Single Components



Configuration Overview | 2.0.3 / 2026.04



Cables



Cable Hirose to Box Lens, [K2.0050125](#)



Camera to FCA Ethernet Cable, [K2.0051067](#)



Cable LENS/ENG (12p) - Hi (12p) analog [K2.0022328](#)



LPS-1 FBS Intercom/Tally/PGM Cable, K2.0051808

Cable LBUS (straight) to LBUS (straight) Length: 0.2m/8", [K2.0006749](#)
 Cable LBUS (straight) to LBUS (straight) Length: 0.3m/1ft, [K2.0006750](#)
 Cable LBUS (straight) to LBUS (straight) Length: 0.5m/1.5ft, [K2.0006751](#)
 Cable LBUS (straight) to LBUS (straight) Length: 0.8m/2.5ft, [K2.0006752](#)
 Cable LBUS (straight) to LBUS (straight) Length: 1.5m/5ft, [K2.0006753](#)
 Cable LBUS (straight) to LBUS (straight) Length: 3m/10ft, [K2.0006754](#)
 Cable LBUS (straight) to LBUS (straight) Length: 6m/20ft, [K2.0006755](#)
 Cable LBUS (straight) to LBUS (straight) Length: 15m/49ft, [K2.0006756](#)
 Cable LCS (5p) - LBUS (0.8m/2.6ft): [K2.0007318](#)

Cable LBUS (angled) to LBUS (straight) Length: 0.35m/1.1ft, [K2.0013042](#)
 Cable LBUS (angled) to LBUS (straight) Length: 0.80m/2.3ft, [K2.0013043](#)
 Cable LBUS (angled) to LBUS (straight) Length: 1m/3.3ft, [K2.0013041](#)
 Cable LBUS (angled) to LBUS (angled) Length: 0.2m/8", [K2.0012785](#)
 Cable LBUS (angled) to LBUS (angled) Length: 0.3m/1ft, [K2.0023823](#)
 Cable LBUS (angled) to LBUS (angled) Length: 0.6m/2ft, [K2.0013040](#)
 Cable LBUS (angled) to LBUS (angled) Length: 0.8m/2.6ft, [K2.0012630](#)

LBUS Star (0.2m/8in). K2.0023823

ALEXA 35 Live - Multicam System - Components



LPS-1 Fiber Camera Adapter FCA-1, [K2.0051089](#)
(only available in Sets)



LPS-1 Fiber Base Station FBS-1, [K2.0051088](#)
(only available in Sets)



Skaarhoj RCP Pro ARRI V2B, [K2.0044481](#)



Tally Light Module TLM-1, [K2.0050656](#)
LBUS cable needed



MVF-2 Viewfinder Set, [K0.0042899](#)



Live Production Monitor LPM-1 Pro Set, KK.0054652



RIA-1 Bracket [K2.0039465](#)



Viewfinder Mounting Bracket VMB-5, K2.0033859



Square Accessory Sleeve SAS-2, K2.0047906



Viewfinder Mounting Set VMB-5, [KK.0034527](#)



LLA-1 Control Module, K2.0051099



Cine License Upgrade for ALEXA 35 Live, 10.0051274



Large Lens Adapter LLA-1, [K2.0050774](#)



LLA-1/BUD Slider Plate, K2.0055339



LLA-1 Plate for AMIRA [K2.0050775](#)



LLA-1 Plate for ALEXA Mini/LF, [K2.0050776](#)



Balance Utility Dovetail BUD-1, [K2.0034180](#)



Monitor Yoke Support MYS-1L (for CCM-1) [K2.0051078](#)



Touchdown Base Plate TBP-1, [K2.0049959](#)



Touchdown Receiver Plate TRP-1, [K2.0049960](#)



Live Production Handle LPH-1, [K2.0050634](#)



camRade rainCover OB/EPF Large, [K2.0050817](#)



Case for LLA-1, [K2.0050793](#)



LPS-1 Fiber Base Station & RCP Case, K2.0051794



ALEXA 35 Live & Accessories Case, K2.0051793



FBS to LC-TAC Adaptor K2.0053874



FBS to ST-TAC Adaptor K2.0053875



LC-TAC to FCA Adaptor K2.0053876



ST-TAC to FCA Adaptor K2.0053877



Shotgun Microphone Holder SMH-1, K2.0055061



Live Production Handle LPH-2, K2.0054985



Monitor Yoke Support MYS-2 (for LPM-1) K2.0054147



Rear Accessory Bracket RAB-4, K2.0055159



Top Soft Pad TSP-1, K2.0055229

ALEXA 35 Live - Multicam System - Setup Classical



Configuration Overview | 2.1.0 / 2024.05

Multicam Setup

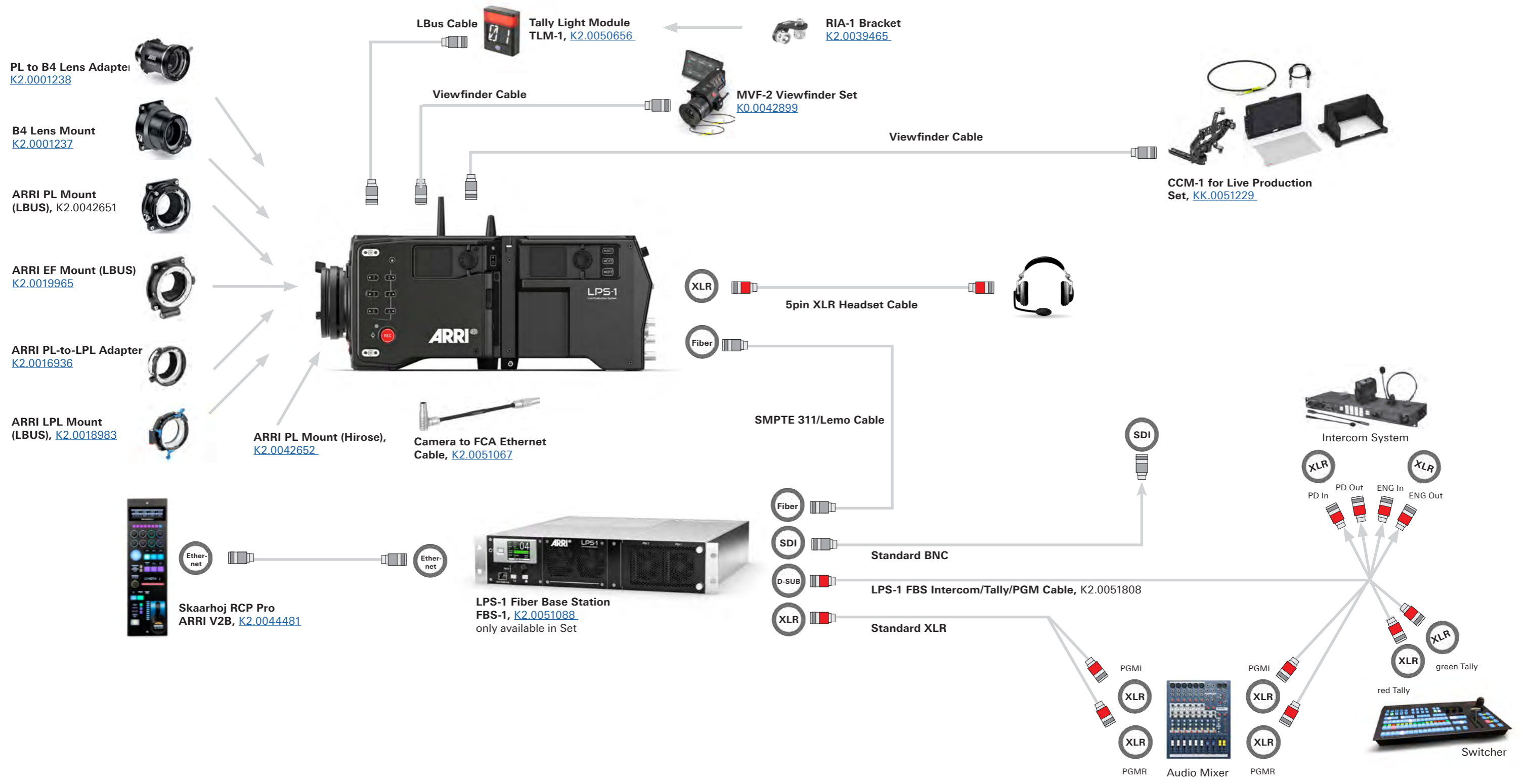

ALEXA 35 Live - Multicam System - Setup Tactical Fiber



Configuration Overview | 2.1.1 / 2025.07

Multicam Setup

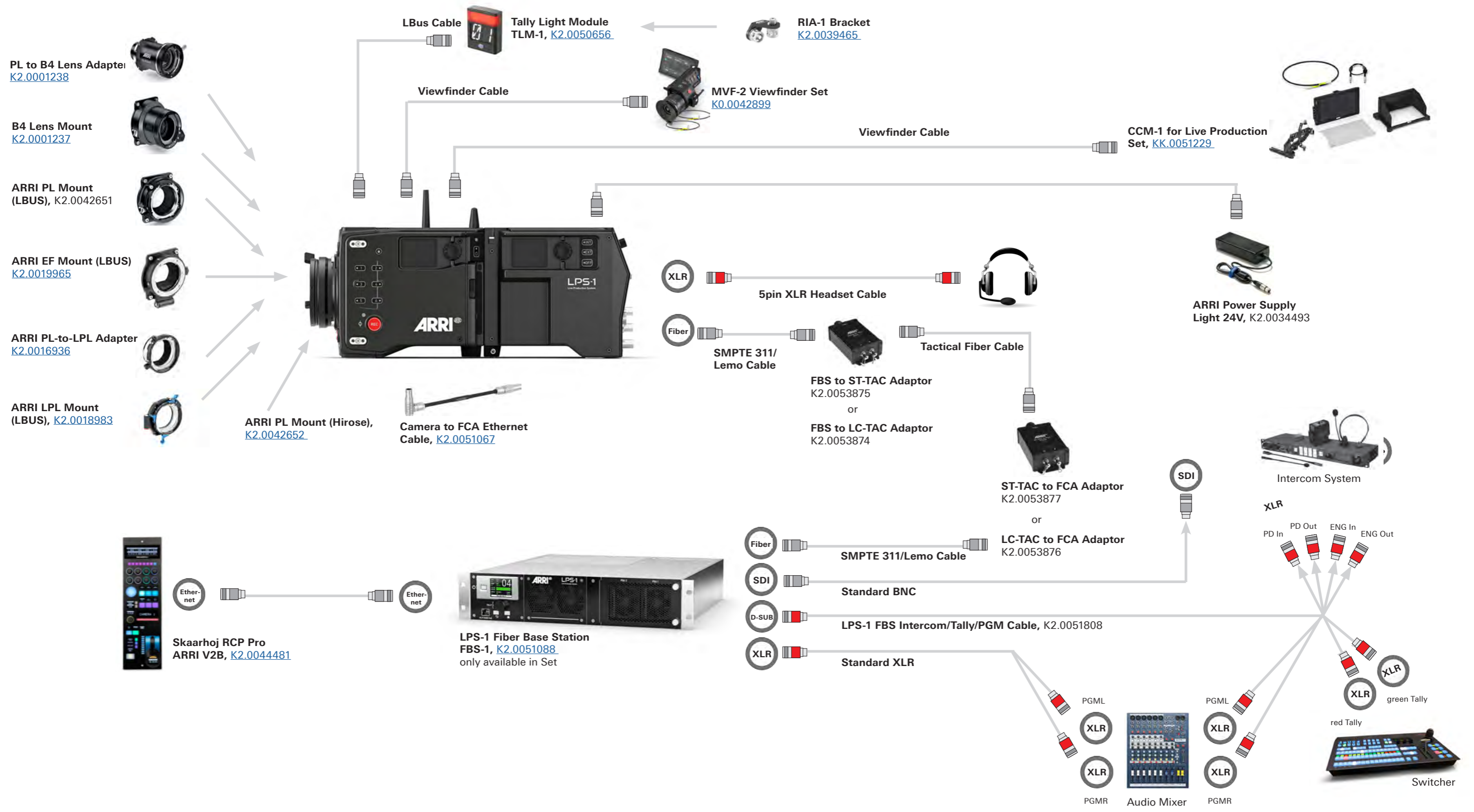

ALEXA 35 Live - Multicam System - Handheld Accessories Setup



Configuration Overview | 2.1.2 / 2024.05

Handheld Accessories Setup

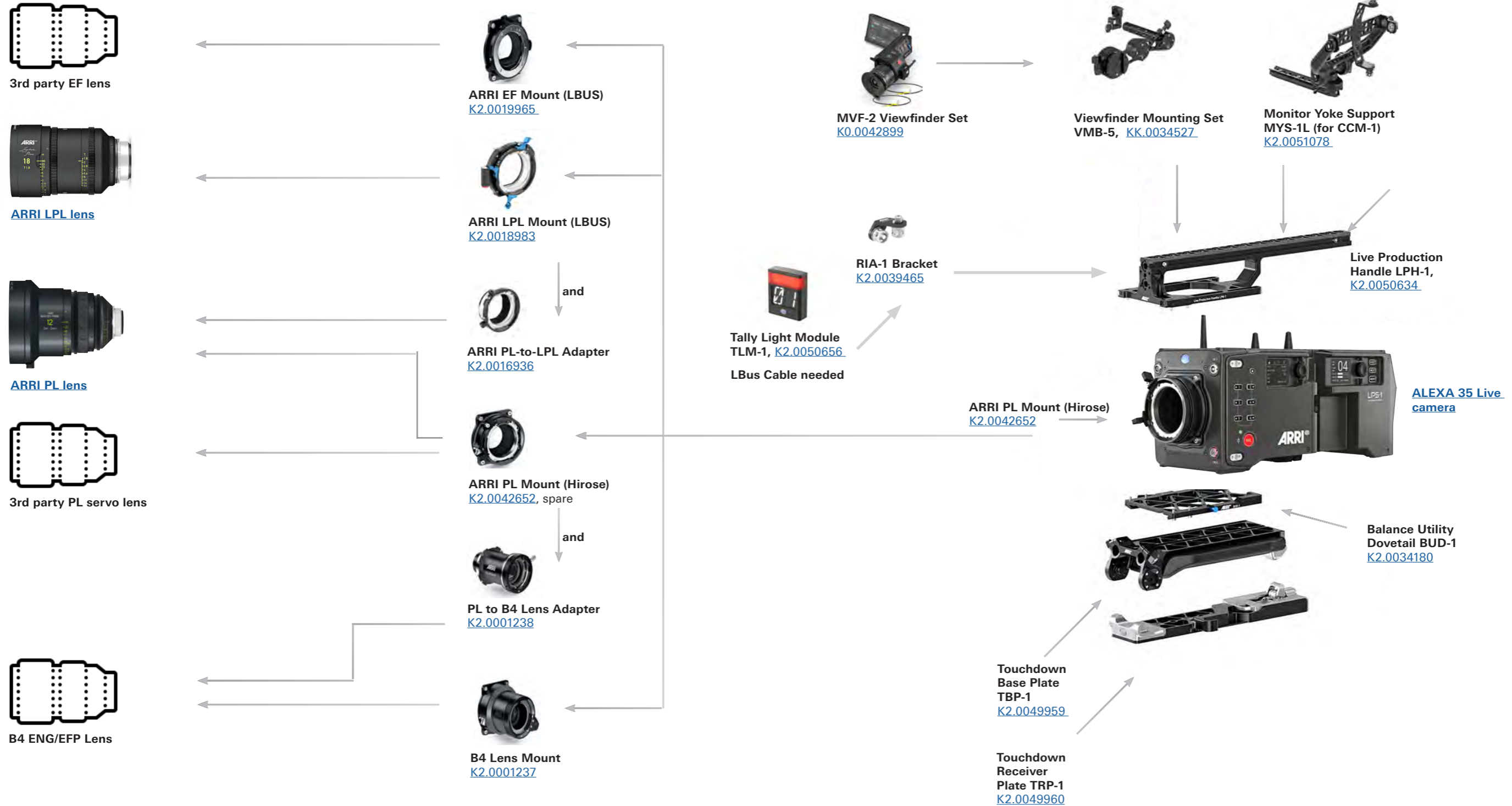

ALEXA 35 Live - Multicam System - Studio Accessories Setup



Configuration Overview | 2.1.3 / 2024.05

Studio Accessories Setup

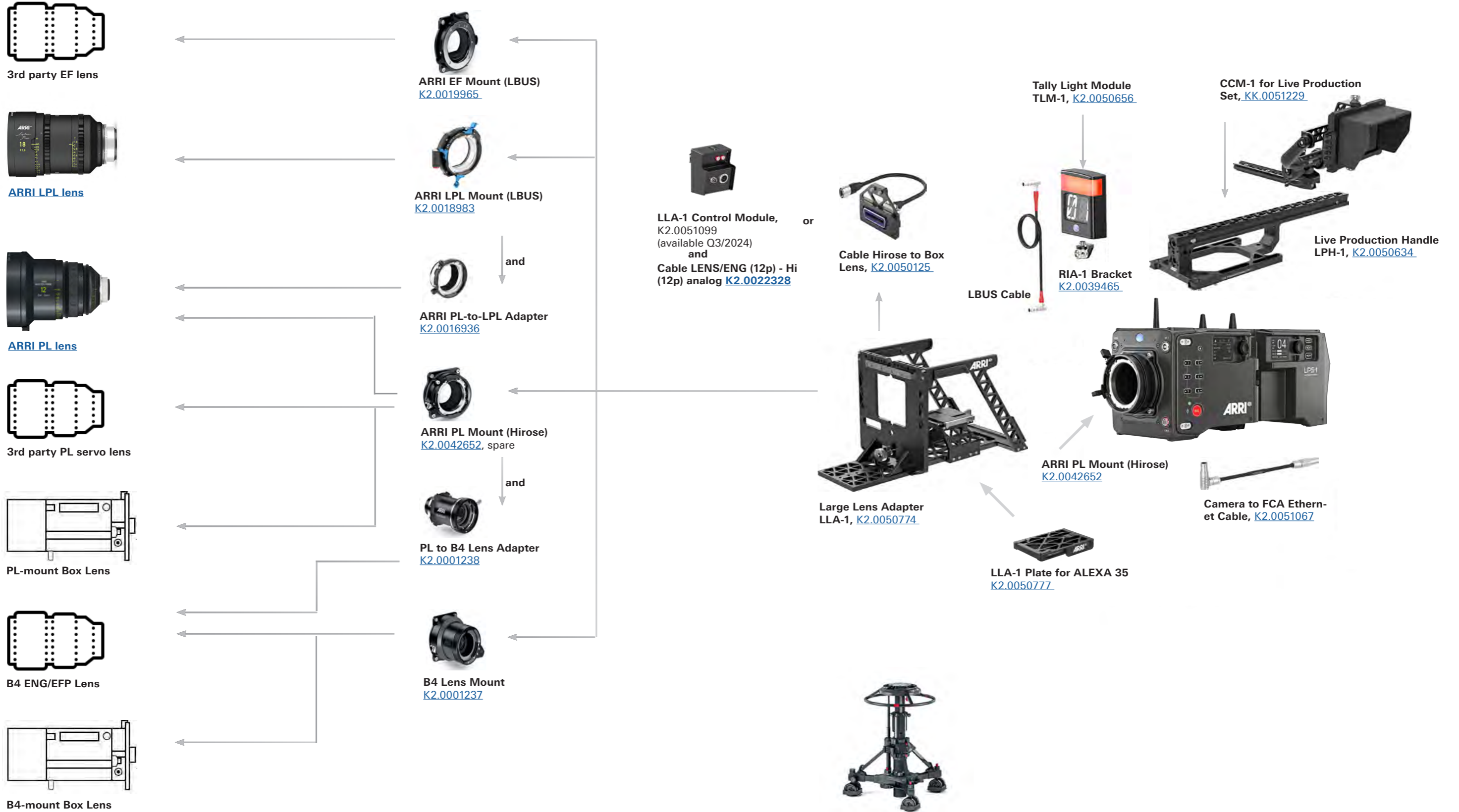

Controls	
CALL	Signals camera operator wants to talk
PROD	Volume of production intercom
ENG	Volume of engineering intercom
PMG	Volume of program audio on intercom
TRACKER	Volume of tracker intercom
PRD	Enables intercom production channel microphone
ENG	Enables intercom engineering channel microphone
REL	Push release button to make a change with A OUT button
A OUT	Switches between AES or analog line level for A OUT when REL is pushed

Controls	
REL	Push release button to make a change with A1 IN button
A1 IN	Switches between MIC 48V/MIC/LINE/AES for A1 IN when REL is pushed
REL	Unlocks (releases) the A2 IN button
A2 IN	Switches between MIC 48V/MIC/LINE/AES for A2 IN once unlocked
SEL	Selects one of the four return in channels for allocation to RET2 button
RT2	Switches from PGM video to the selected return in channel
SEL	Selects one of the four return in channels for allocation to RET1 button
RT1	Switches from PGM video to the selected return in channel



ALEXA 35 Live - Multicam System - LPS-1 Fiber Camera Adapter - Connectors



Configuration Overview | 2.2.1 / 2024.05

Connectors	
HEADSET	XLR 5-pin socket for intercom headset
A OUT	XLR 3-pin plug for AES or analog line audio out
A1 IN	XLR 3-pin socket for audio input 1 (MIC 48V/MIC/LINE/AES)
A2 IN	XLR 3-pin socket for audio input 2 (MIC 48V/MIC/LINE/AES)
FIBER	Lemo 3K SMPTE 311M fiber connector (socket)
AUX FIBER	Neutrik Opticon connector for auxiliary fiber tunnel
12V/4A	Lemo EGG socket for 12V accessory power output*
12V/2A	Lemo EGG socket for 12V accessory power output
12V/2A	Lemo EGG socket for 12V accessory power output
24V/4A	ARRI RS Lemo socket for 24V accessory power output*

Connectors	
GPIO	Hirose 10-pin HR10A connector
TRACKER	Hirose 20-pin HR10A connector
SDI1 OUT	BNC Monitor out (= ALEXA 35 SDI 1 out)
RET OUT	BNC Monitor output of return video in from Fiber Base Station
RCP PoE	RJ45 Ethernet for direct RCP connection
ETH	RJ45 for auxiliary 1 Gbit/s Ethernet tunnel
LLA PoE	RJ45 Ethernet for Large Lens Adapter interface module for future use
REF OUT	BNC Genlock out
AUX	BNC Auxiliary/Teleprompter SDI out



ALEXA 35 Live - Multicam System - LPS-1 Fiber base station



Configuration Overview | 2.2.2 / 2024.06

Connectors	(backside)
PSU 1	IEC 320 Universal AC mains power input (100 – 240V, 50/60Hz)
PSU 2	IEC 320 Universal AC mains power input (100 – 240V, 50/60Hz)
AUX FIBER	Neutrik Opticon connector for auxiliary fiber tunnel
CAMERA	Lemo 3K SMPTE 311M fiber connector (plug)
AUX TP IN	BNC input auxiliary/teleprompter (SDI up to 12G)
MON	BNC output with status overlay (SDI up to 3G)
HD OUT 1/2	2x BNC outputs for down converted HD signal (SDI up to 3G), progressive or interlaced
3G-SDI OUT (1) 1-4	4x BNC outputs for 4x single link 3G or 1x quad link 12G
3G-SDI OUT (2) 1-4	4x BNC outputs for 4x single link 3G or 1x quad link 12G
12G-SDI	4x BNC outputs for up to 4x single link 12G or 2x dual link 6G
RETURN IN 1-4	4x BNC inputs for return video (up to 3G)
GPIO	D-sub 15-pin for general purpose I/O
INTERCOM/TALLY/PGM	D-sub 25-pin for Intercom audio in/out, PGM audio in and Tally control (SONY style connector and pin-assignments)
REF OUT	1x BNC output for active genlock (black burst or tri-level sync) derived from PTP or analog REF IN

Connectors	(backside)
TC IN	1x BNC input for linear timecode
REF LOOP	1x BNC loop output of genlock input signal (black burst or tri-level sync)
REF IN	1x BNC input for genlock signal (black burst or tri-level sync)
AUDIO1 OUT	XLR 3-pin plug (line level or AES) for balanced analog or digital audio
AUDIO2 OUT	XLR 3-pin plug (line level or AES) for balanced analog or digital audio
AUDIO1 IN	XLR 3-pin socket (line level or AES) for balanced analog or digital audio
AUDIO2 IN	XLR 3-pin socket (line level or AES) for balanced analog or digital audio
LBUS	ARRI LBUS connector for future use
ST2110/SFP28	SFP28 transceiver modules with LC fiber connector (up to 25G) for SMPTE 2110, primary or redundant
ST2110/SFP28	SFP28 transceiver modules with LC fiber connector (up to 25G) for SMPTE 2110, primary or redundant
ETH TUNNEL	RJ45 for auxiliary 1 Gbit/s Ethernet tunnel
MGM PORT 2	RJ45 for multicam web interface
RCP PoE	RJ45 for remote control panels (with power)
MGM PORT 1	RJ45 for multicam web interface

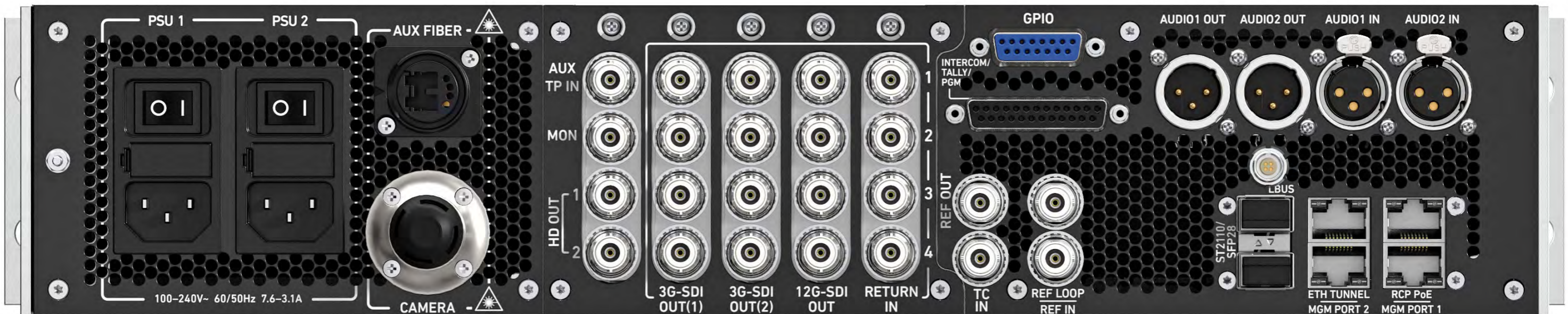

Configuration Overview | 2.2.3 / 2026.02

BASIC SYSTEM SETUP:

Four IP addresses must be assigned for one camera chain, each for the camera, the Fiber Camera Adapter, the Fiber Base Station and the Remote-Control Panel.

All components must be in the same subnet and use the same subnet and gateway settings in order to establish a connection. **The IP addresses shown are the defaults used on the Demo System.**

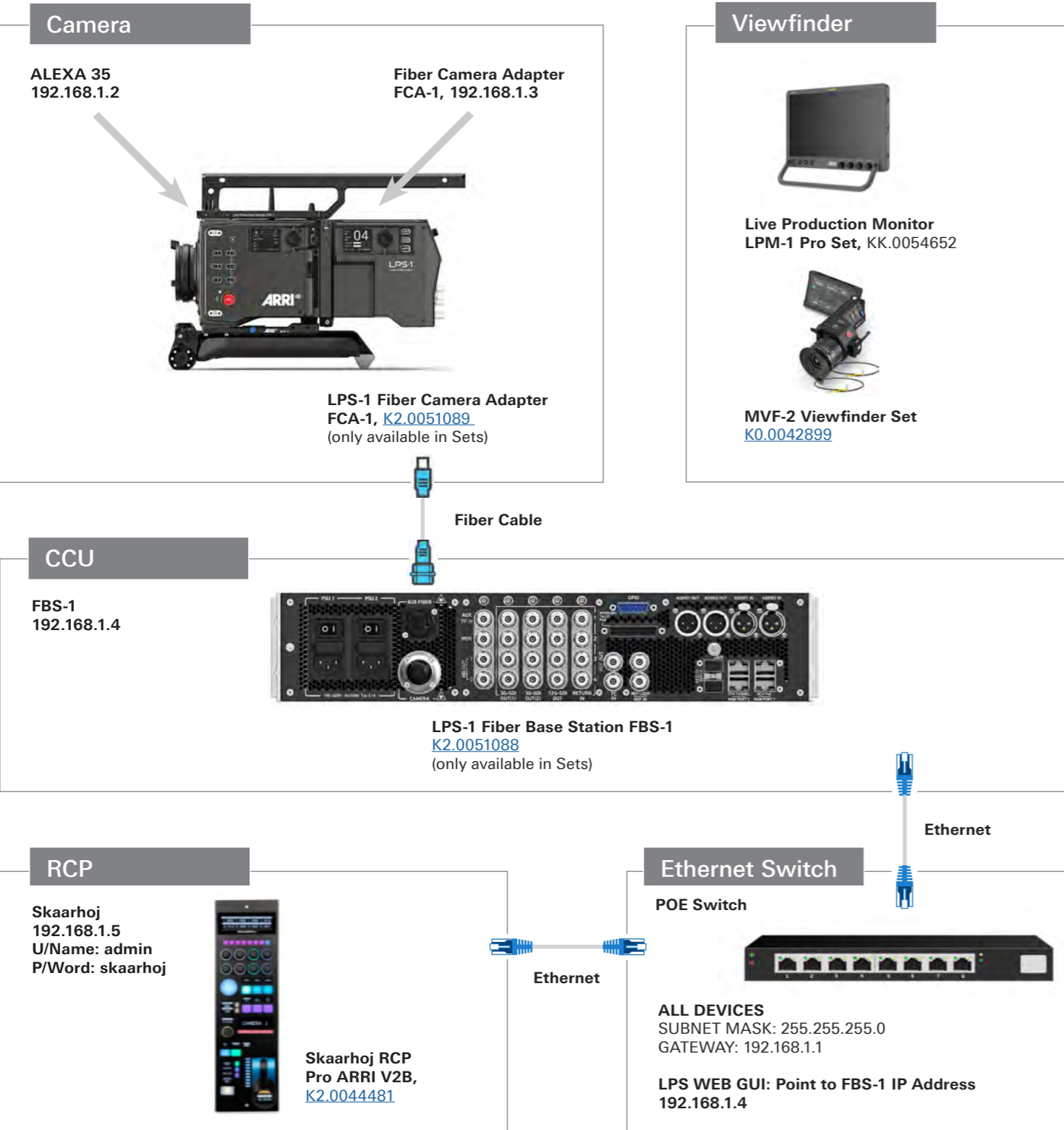

CAMERA NETWORK SETUP: Menu Path	Setting	Description
MENU > System > Network > LAN IP Mode	Static	Set the LAN IP Mode to Static to assign the camera a fixed IP address
MENU > System > Network > LAN Static IP	192.168.1.1	Set the IP address of the camera
MENU > System > Network > LAN Static Subnet	255.255.255.0	Set the subnet mask
MENU > System > Network > LAN Static Gateway	192.168.1.1	Set the default gateway
MENU > System > Camera Access Protocol > CAP Server Password	arri	Set a password for the CAP server, default = arri

FBS NETWORK SETUP: Menu Path	Setting	Description
MENU > Network > FBS ID	1	Set the ID of the Fiber Base Station
MENU > Network > Cam Channel	1	Set the camera channel number (1-99)
MENU > Network > IP Mode	Static	Set the IP Mode to STATIC to assign the FBS a fixed IP
MENU > Network > FBS IP	192.168.1.4	Set the IP address of the Fiber Base Station
MENU > Network > LAN Static Subnet	255.255.255.0	Set the subnet mask
MENU > Network > LAN Static Gateway	192.168.1.1	Set the default gateway

LPS-1 WEB UP SETTINGS: Menu Path	Setting	Description
Open the LPS-1 Web UI by entering the IP address of the Fiber Base Station in the address bar of a web browser. The IP address of the FBS is shown on the display of the Fiber Base Station.		
NETWORK > Camera IP Address	192.168.1.2	Enter the IP address of the camera connected to FBS
NETWORK > Camera Password	arri	Enter the CAP Password for the connected Camera

SKAARHOJ RCP NETWORK SETUP: Menu Path	Setting	Description
Open the Skaarhoj Web UI by entering the IP address of the RCP in the address bar of a web browser. The IP address of the RCP is shown on the display during start-up or can be called up by pressing the SETUP button twice on the RCP. The default user name is: admin, password: skaarhoj		
SETTINGS > IP Configuration > IP Address	192.168.1.5	Set the IP address of the RCP
SETTINGS > IP Configuration > Subnet Mask	255.255.255.0	Set the subnet mask
SETTINGS > IP Configuration > Gateway	192.168.1.1	Set the default gateway
HOME > Devices > Add Device > Add Manually		Add a camera to the devices list. Select ALEXA35 enter the IP address and the CAP password of the camera to be controlled. E.g. 192.168.1.2, arri

ALEXA 35 Live - ECS Wireless Cine Application



Configuration Overview | 2.2.4 / 2025.09

ALEXA 35 Live & cforce mini Motor Wireless Application



ALEXA 35 Live - Iris control via RCP & Zoom and Focus control via Hand Units

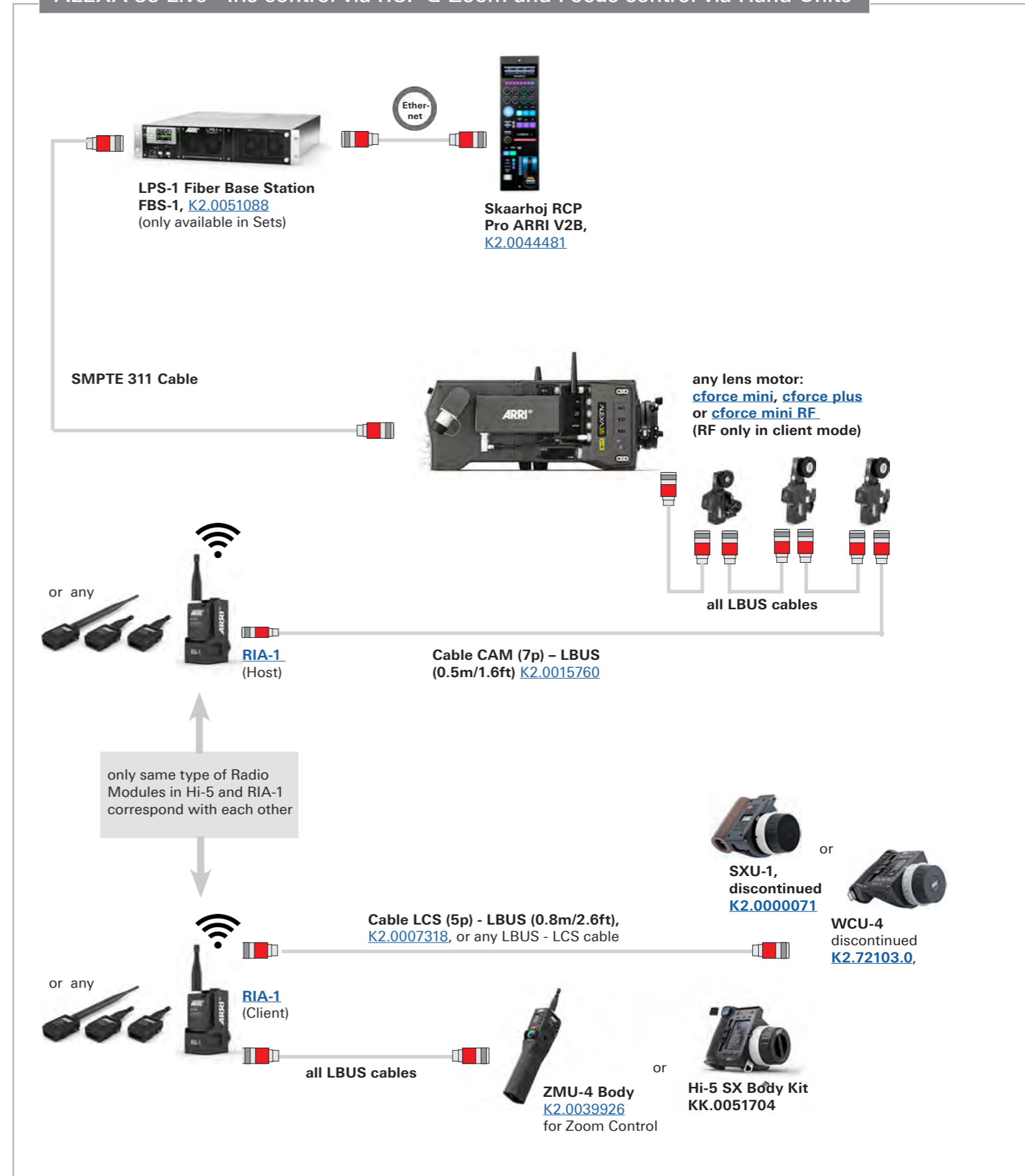

ALEXA 35 Live & RIA-1 & OCU-1 or Master Grips and LBUS Control Units

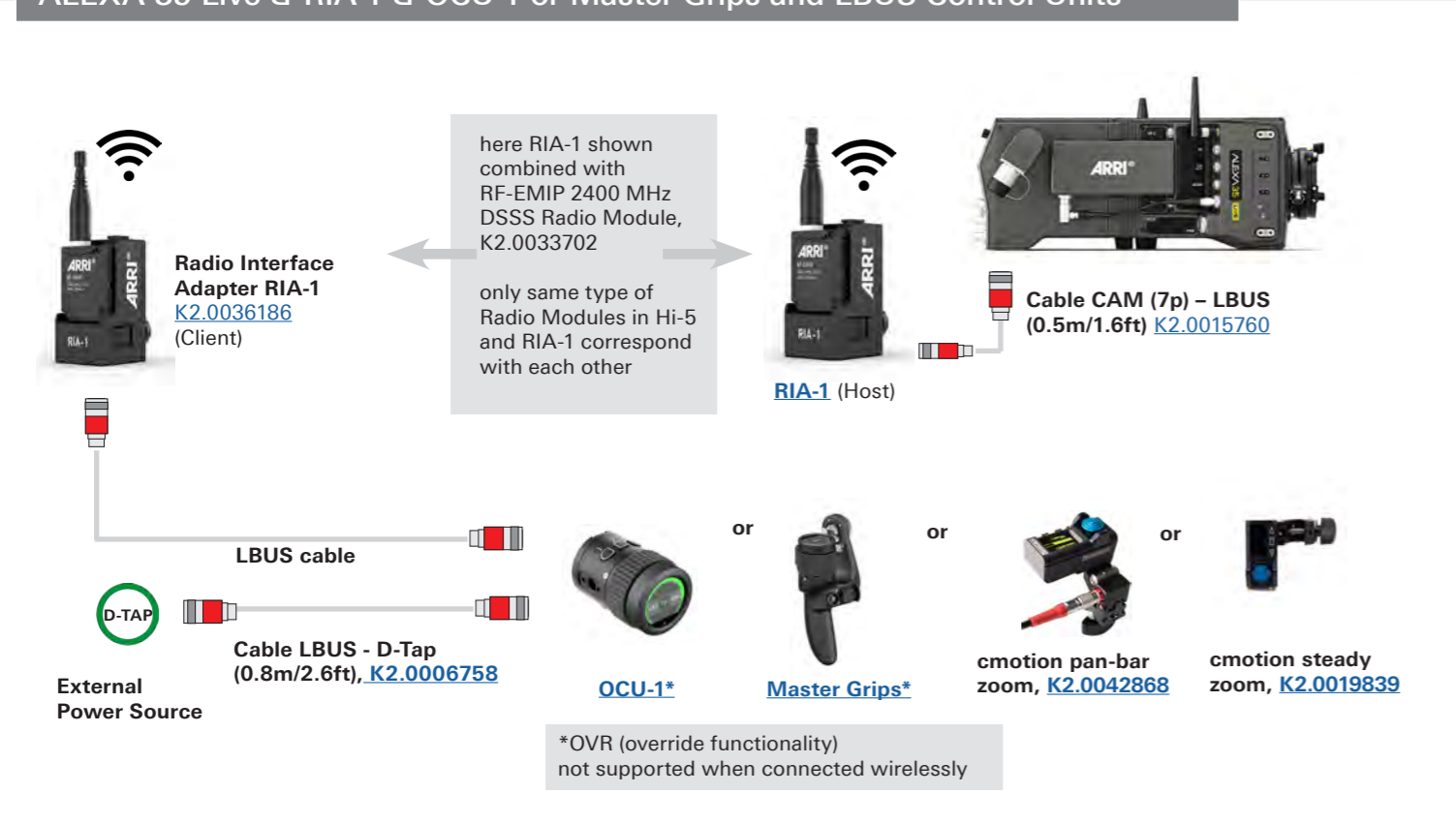

ALEXA 35 Live - ECS Box Lens Application



Configuration Overview | 2.2.5 / 2025.04

ALEXA 35 Live & Box Lenses - Wireless Zoom/Focus

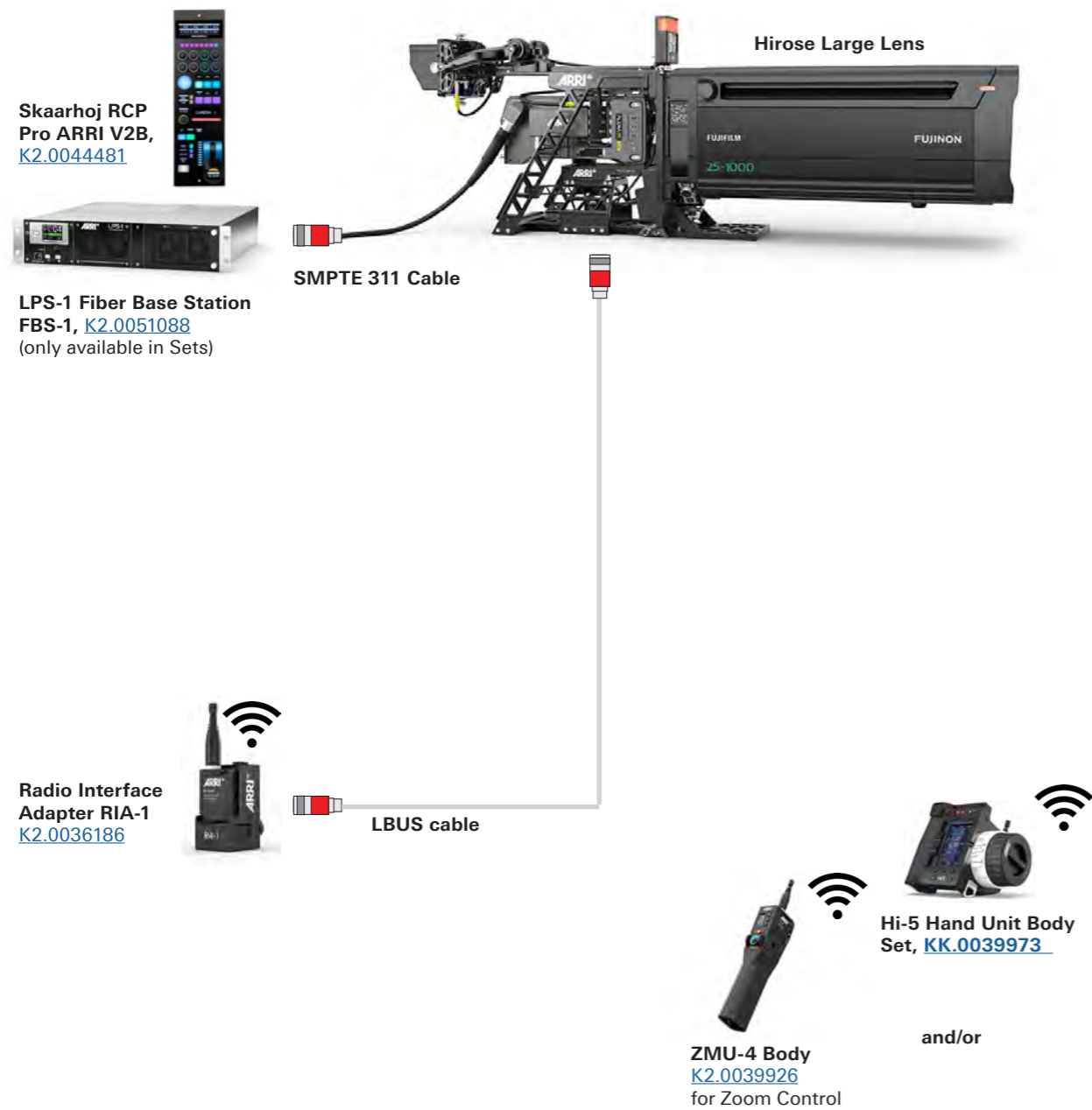

ALEXA 35 Live & Box Lenses - Hard Wired

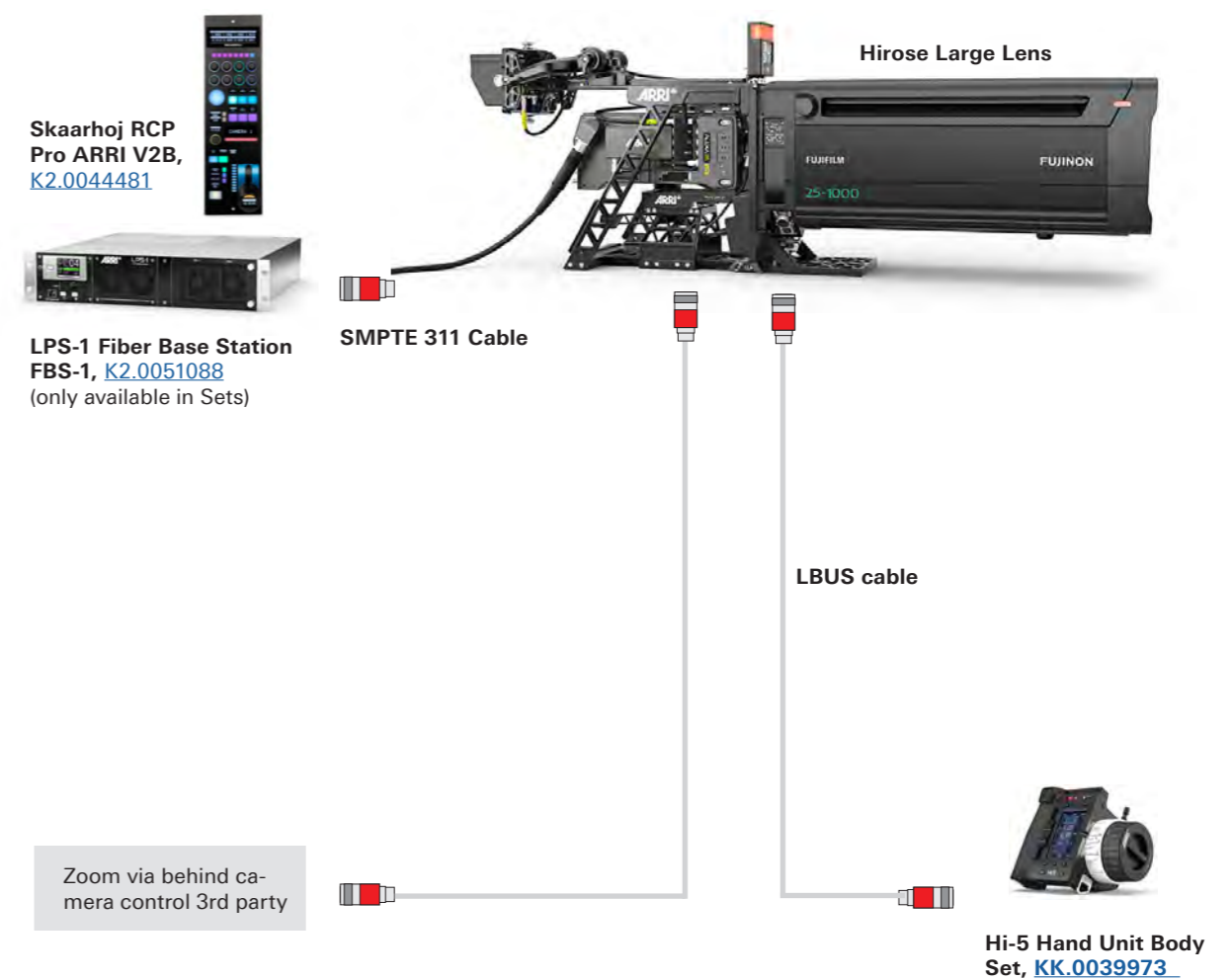

ALEXA 35 Live - ECS General Control Application



Configuration Overview | 2.2.6 / 2025.04

ALEXA 35 Live & Mastergrip - Servo Zoom Lens

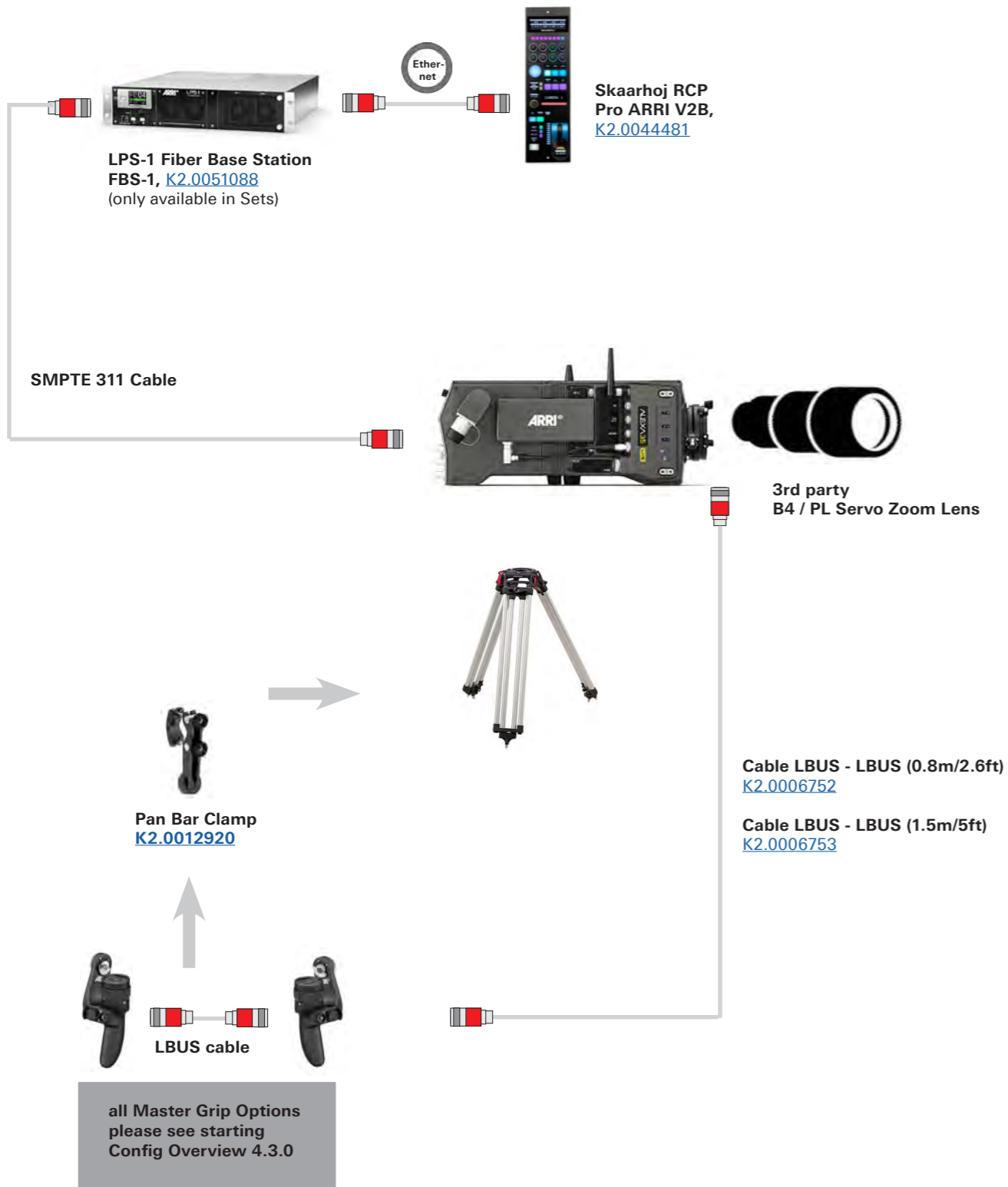

ALEXA 35 Live & Mastergrip - Cine Lens

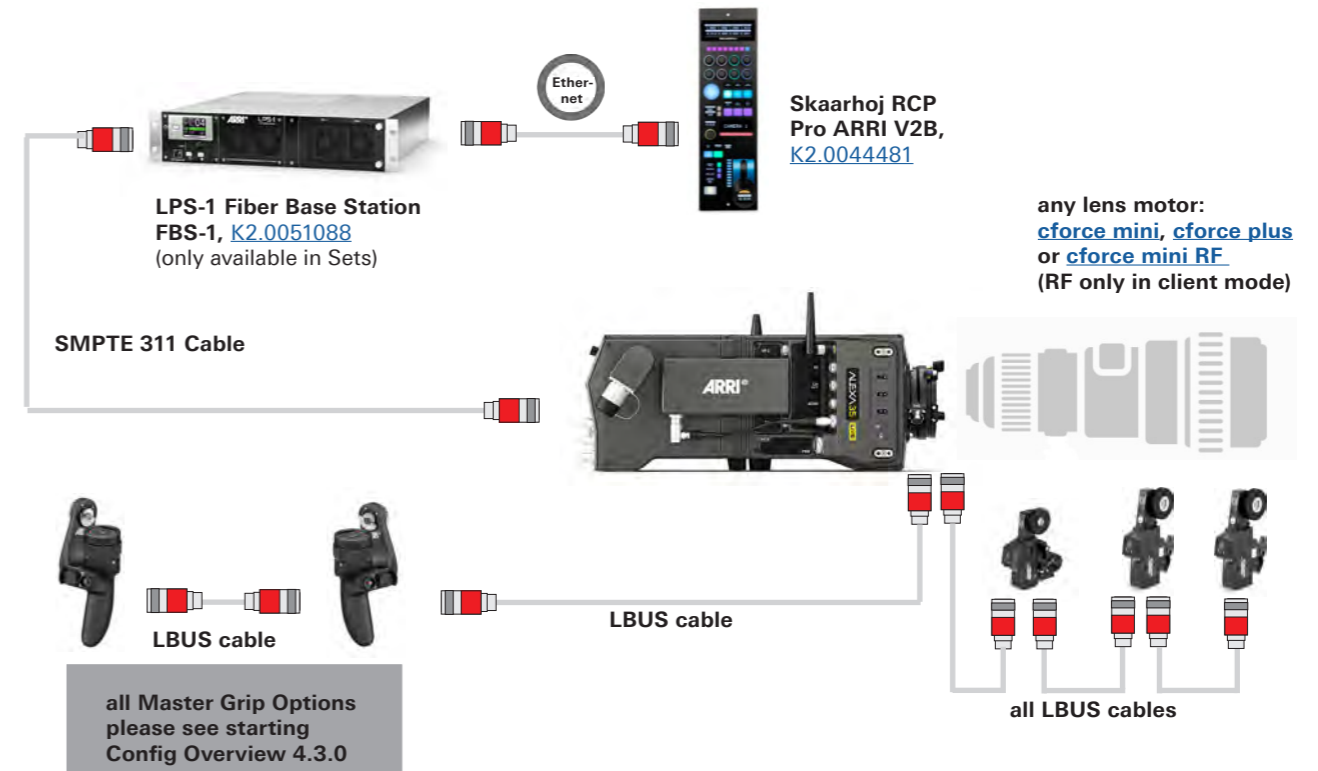

ALEXA 35 Live & UDM-1



AMIRA Live - Setup & Cable Configuration



Configuration Overview | 2.3.0 / 2023.11

Multicam Setup

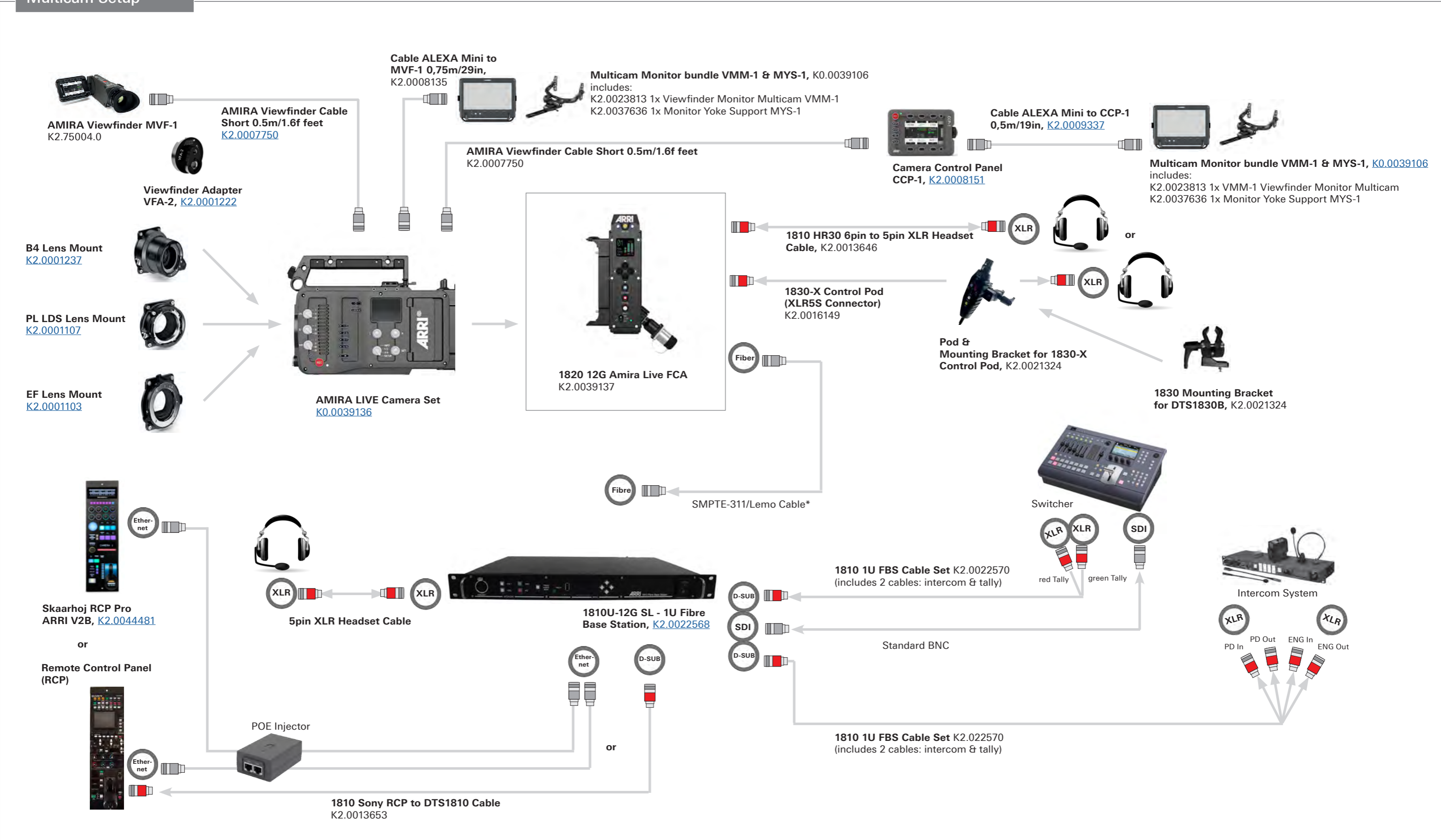

AMIRA Live - Mechanical Accessories Setup



Configuration Overview | 2.3.1 / 2023.11

Mechanical Accessories Setup

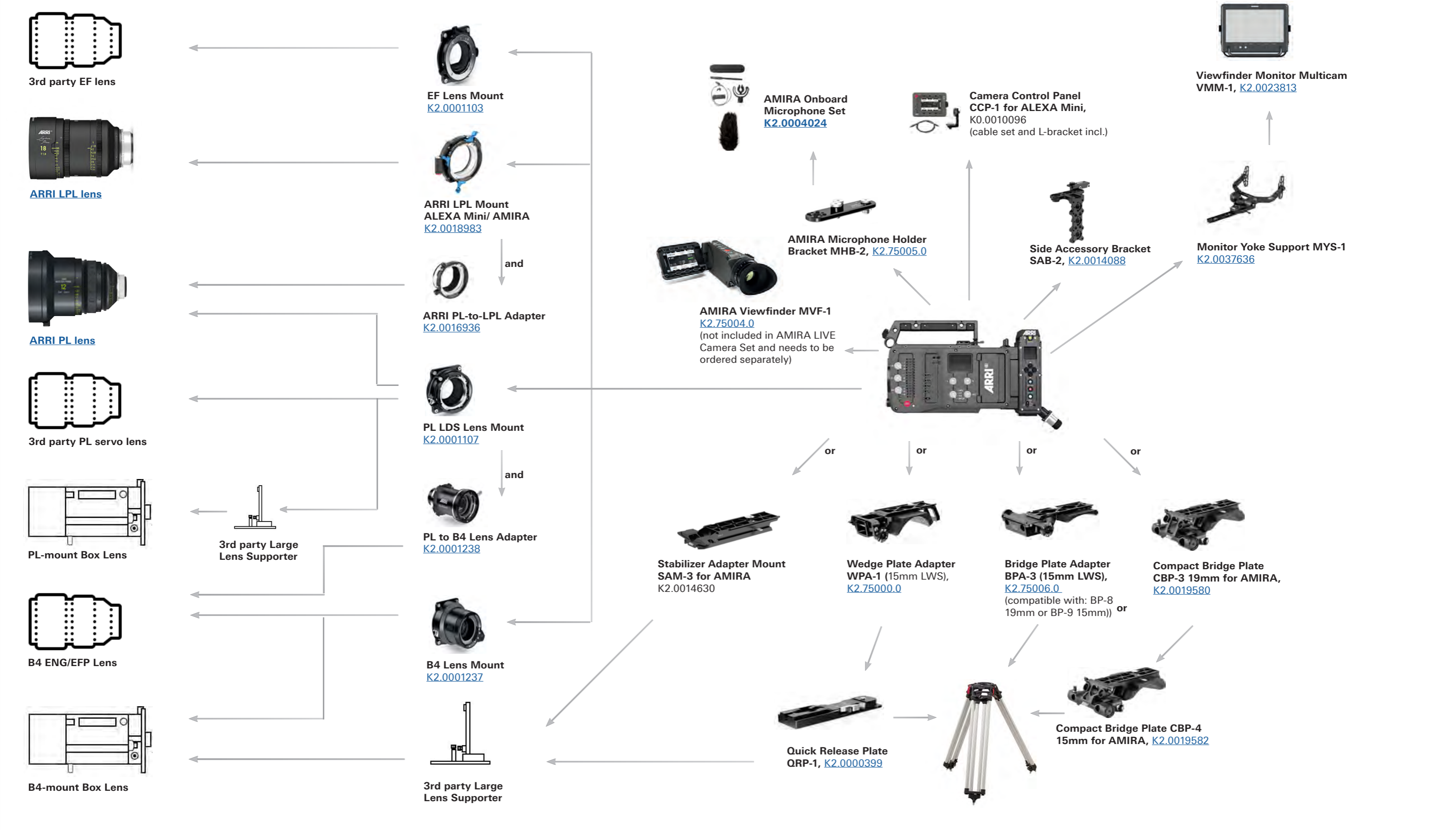

AMIRA Live Sets



AMIRA LIVE Camera Set, K0.0039136
includes:
KK.0038511 1x AMIRA LIVE camera body (incl. CL kit K2.0023813)
10.0001093 1x AMIRA Advanced License Key
10.0003723 1x AMIRA 4K UHD License Key
10.0014641 1x AMIRA ARRI Look Library License Key

Note: viewfinder & lensmount not included and need to be ordered separately



AMIRA LIVE 1800 Camera Chain Set, K0.0039163
includes:
K2.0039137 1x 1820 12G Amira Live FCA
K2.0038531 1x 1800 AMIRA Live Frame Mount
K2.0022568 1x 1810U-12G SL - 1U Fibre Base Station
K2.0022570 1x 1810 1U FBS Cable Set
K2.0016149 1x 1830-X Control Pod (XLR5S Connector)
K2.0021324 1x Mounting Bracket for 1830-X Control Pod

1820 12G Amira Live FCA, K2.0039137



1800 Multicam Sets for ARRI Camera



for ALEXA Mini / Mini LF

for Amira



1800 Set 1U FBS (4x3G&SL12G), K0.0022756
includes:
K2.0013648 1x 1820-12G FCA Fibre CameraAdaptor 12G
K2.0014813 1x 1820 FCA Lemo assembly
K2.0014814 1x 1820 FCA Cable set for AMIRA
K2.0014659 1x 1835 Dual Link 6G Video Input Option
K2.0022568 1x 1810U-12G SL - 1U Fibre Base Station
K2.0022570 1x 1810 1U FBS Cable Set

Cable Set

1820 FCA Cable set for ALEXA Mini/Mini LF, K2.0048472
includes:
ALEXA MINI/LF-ETH 0,36m Cable
ALEXA MINI/LF-GL 0,19m Cable
ALEXA MINI/LF-SDI1 0,19m Cable
ALEXA MINI/LF-SDI2 0,2m Cable
ALEXA MINI/LF-Monitor 0,45m Cable



Monitor

Multicam Monitor bundle VMM-1 & MYS-1, K0.0039106
includes:
K2.0037636 1x Monitor Yoke Support MYS-1
K2.0023813 1x Viewfinder Monitor Multicam VMM-1
includes: 1x standard sunshade plus
K2.0012223 1x AMIRA to CCP-1 Cable 0,75m/29in
K2.0009336 1x ALEXA Mini to CCP-1 Cable 0,75m/29in
K2.0037711 1x VMM-1 Power Cable 0.4m/16in

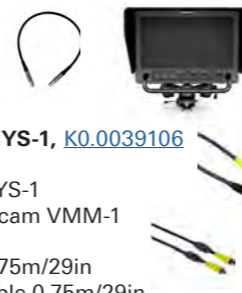

Multicam Single Components

1820-12G FCA Fiber Camera Adaptor K2.0013648

1820 FCA Lemo assembly, K2.0014813



1835 Dual Link 6G Video Input Option K2.0014659 (board built in)



1820 FCA Cable set for AMIRA K2.0014814



1810U-12G SL - 1U Fibre Base Station, K2.0022568



1810 1U FBS Cable Set, K2.0022570



Skaarhoj RCP Pro ARRI V2B K2.0044481



Skaarhoj RCP Tally PVW Cable, K2.0041503



1810 HR30 6pin to 5pin XLR Headset Cable, K2.0013646



1800 2071A Tally Box, K2.0013652



1820 Cord Control Pod with XLR5S connect, K2.0016149



1830 Mounting Bracket for DTS1830B, K2.0021324



FBS 1810 Remote Tally Cable, K2.0041502



AMIRA Viewfinder MVF-1 K2.75004.0
(not included in AMIRA LIVE Camera Set and needs to be ordered separately)



SMPTE 311 Cable (20 m/65 ft), K2.72087.0

Microphone



AMIRA Onboard Mikrophone Set, K2.0004024



Microphone Holder Bracket MHB-2, K2.75005.0

AMIRA / ALEXA Mini / ALEXA Mini LF Multicam - Setup



Configuration Overview | 2.3.3 / 2023.11

Multicam Setup

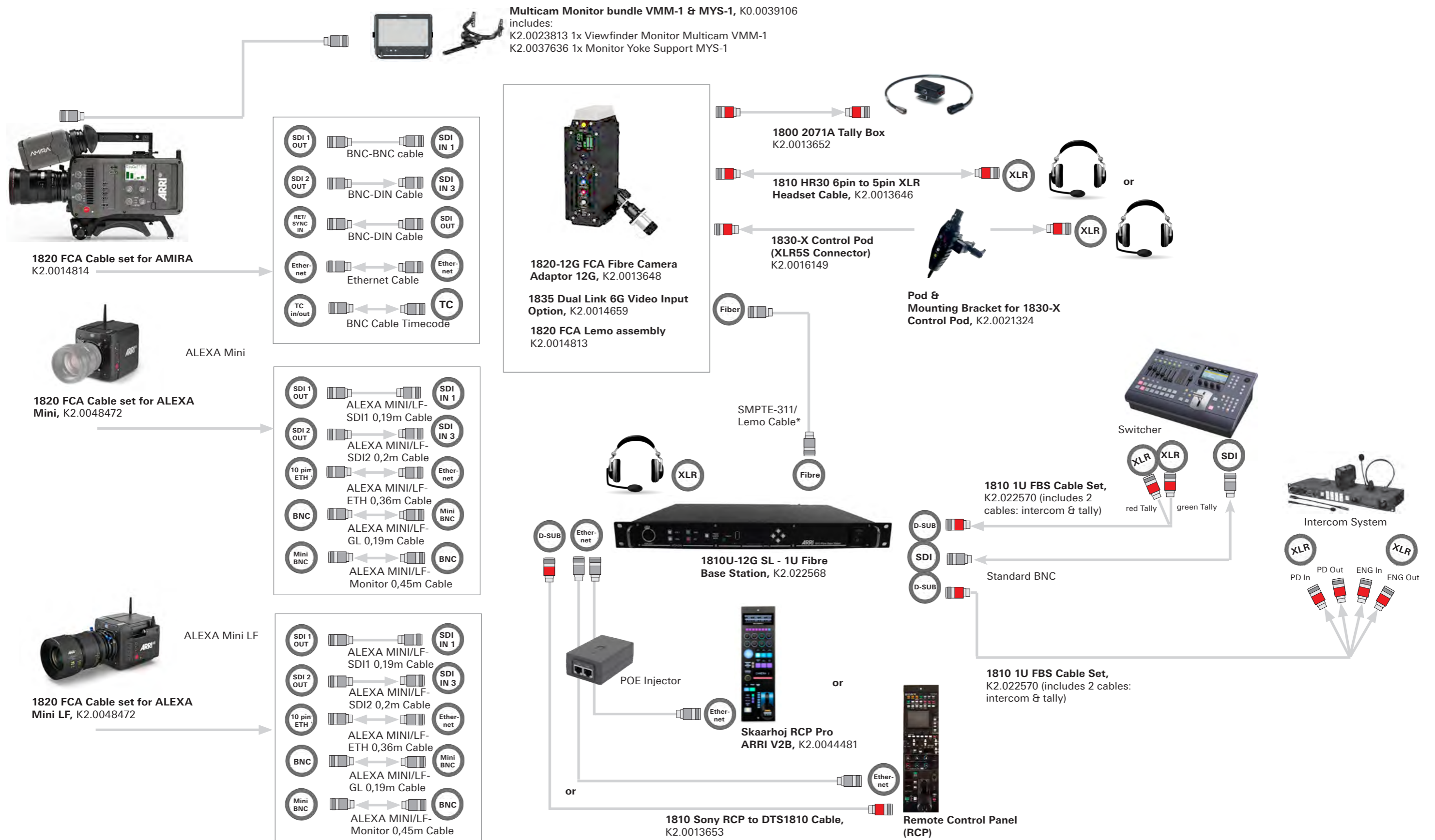

AMIRA Multicam - Mechanical Accessories Setup



Configuration Overview | 2.4.0 / 2024.1

Mechanical Accessories Setup

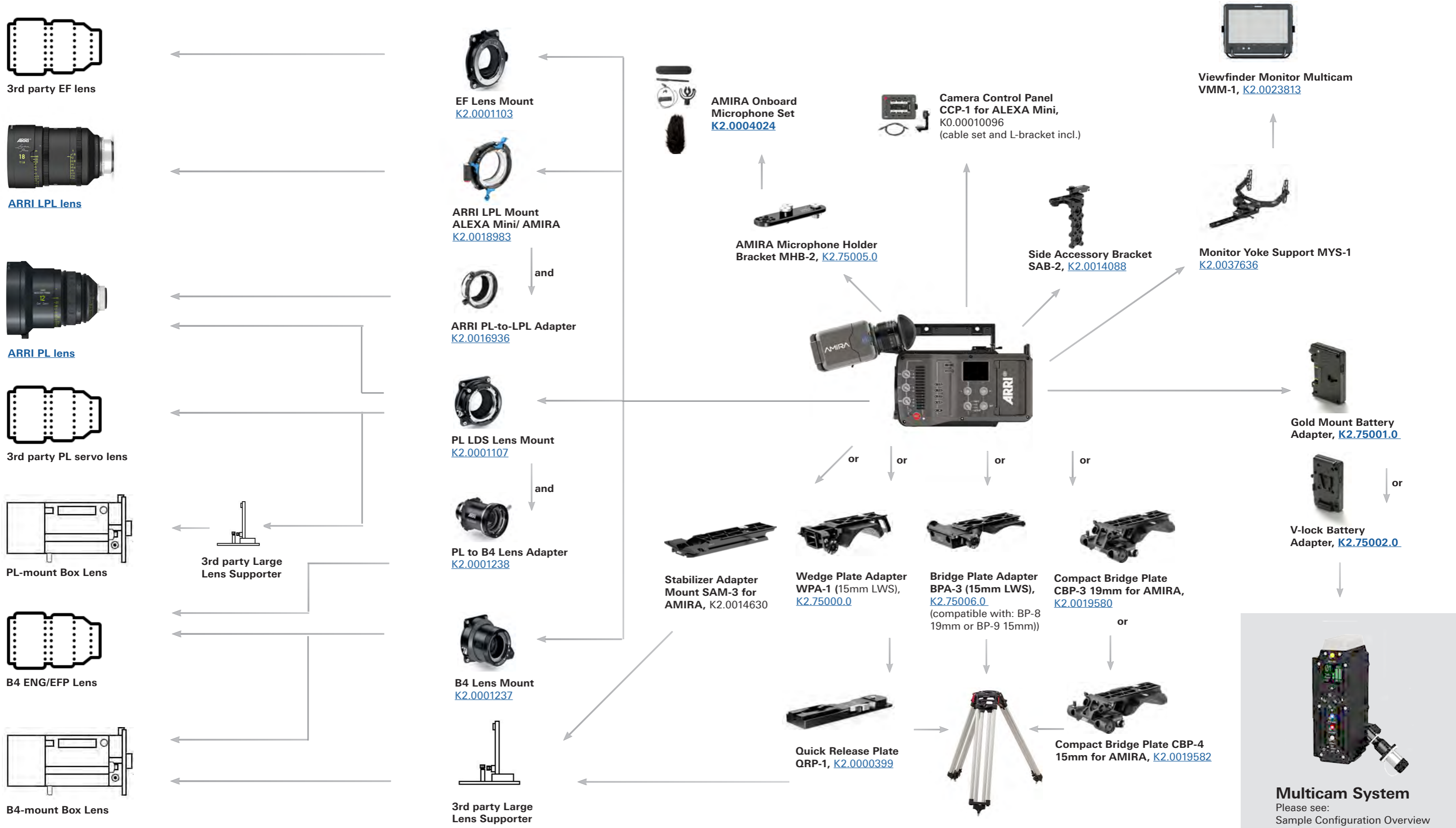

Amira Multicam Cine Style Lens Setup - ECS Sample Configuration



Configuration Overview | 2.4.1 / 2023.11

AMIRA - Cine Style Lens

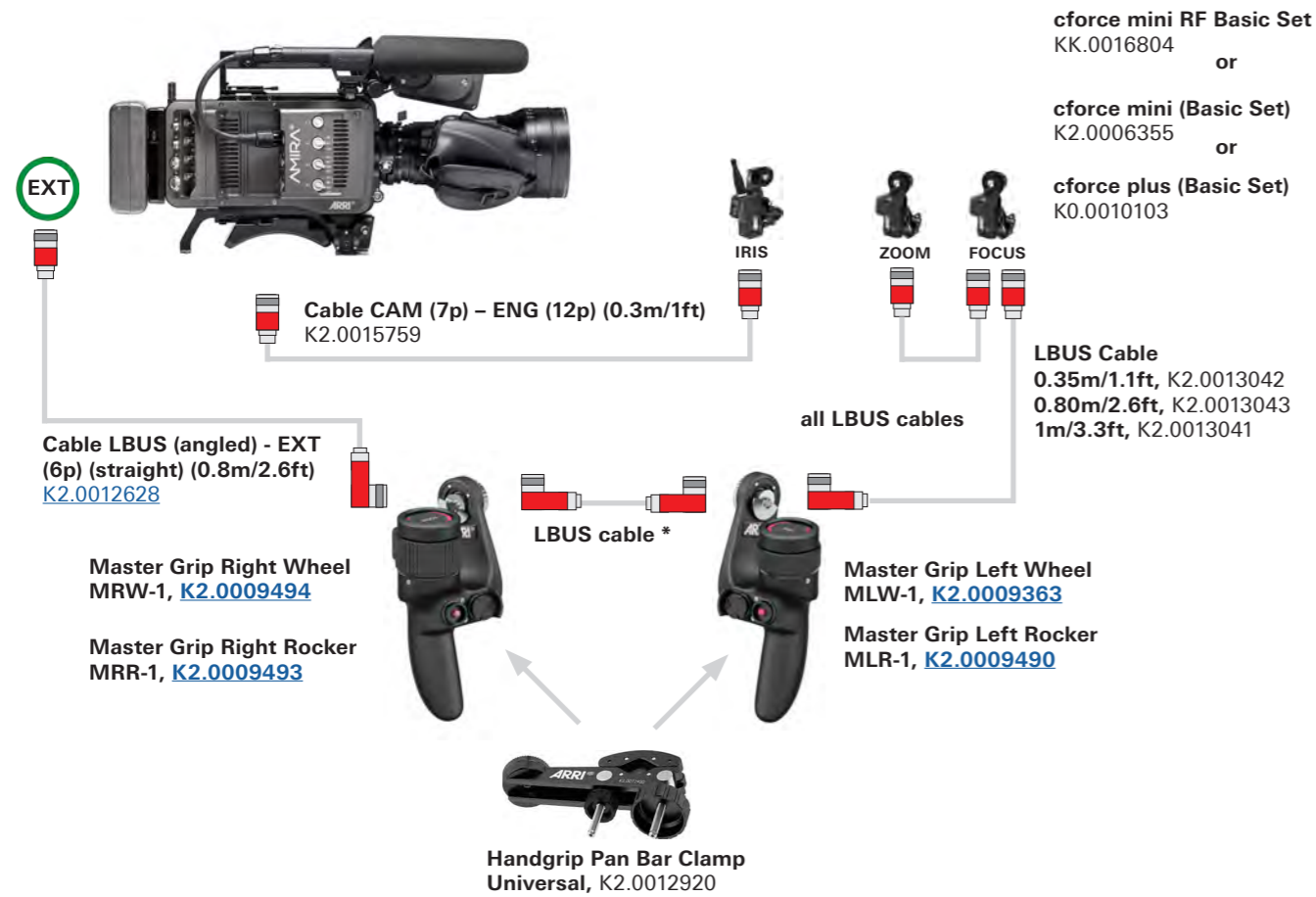

cforce mini



cforce plus

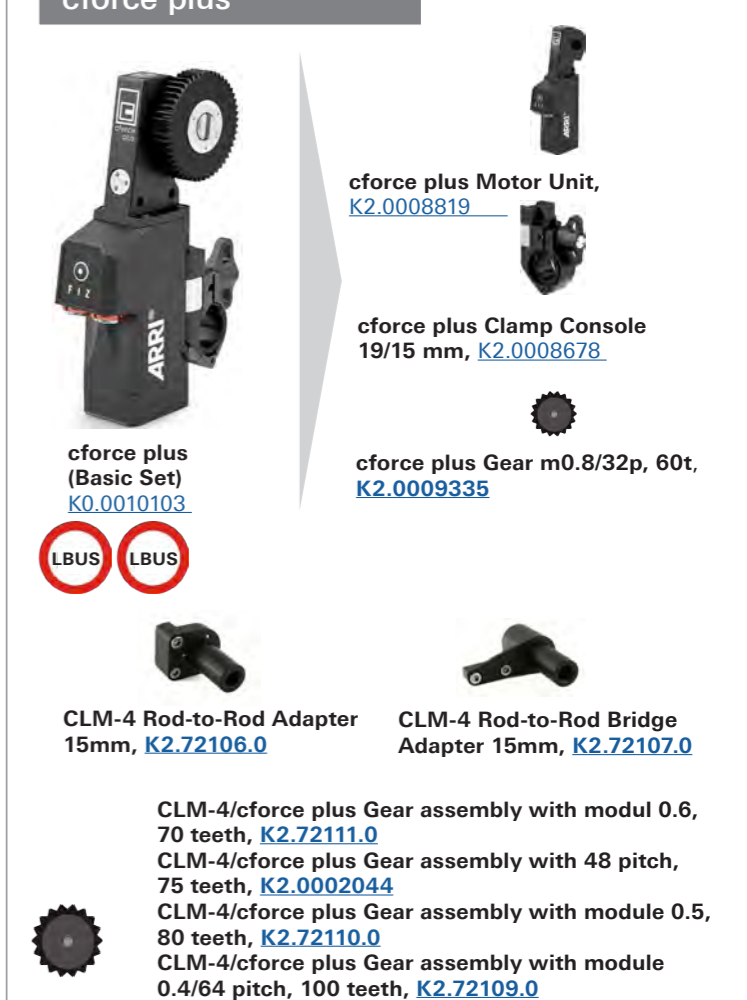

LBUS Cables

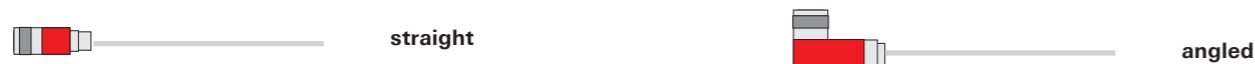

Cable LBUS (straight) to LBUS (straight)
Length: 0.2m/8", K2.0006749
Cable LBUS (straight) to LBUS (straight)
Length: 0.3m/1ft, K2.0006750
Cable LBUS (straight) to LBUS (straight)
Length: 0.5m/1.5ft, K2.0006751
Cable LBUS (straight) to LBUS (straight)
Length: 0.8m/2.5ft, K2.0006752
Cable LBUS (straight) to LBUS (straight)
Length: 1.5m/5ft, K2.0006753
Cable LBUS (straight) to LBUS (straight)
Length: 3m/10ft, K2.0006754
Cable LBUS (straight) to LBUS (straight)
Length: 6m/20ft, K2.0006755
Cable LBUS (straight) to LBUS (straight)
Length: 15m/49ft, K2.0006756
Cable LBUS (straight) to LBUS (straight)
Length to LCS: K2.0007318

Cable LBUS (angled) to LBUS (straight)
Length: 0.35m/1.1ft, K2.0013042
Cable LBUS (angled) to LBUS (straight)
Length: 0.80m/2.6ft, K2.0013043
Cable LBUS (angled) to LBUS (straight)
Length: 1m/3.3ft, K2.0013041
Cable LBUS (angled) to LBUS (angled)
Length: 0.2m/8", K2.0012785
Cable LBUS (angled) to LBUS (angled)
Length: 0.6m/2ft, K2.0013040
Cable LBUS (angled) to LBUS (angled)
Length: 0.8m/2.6ft, K2.0012630

Cable LBUS Star (0.2m/8in). K2.0023823

cforce mini RF

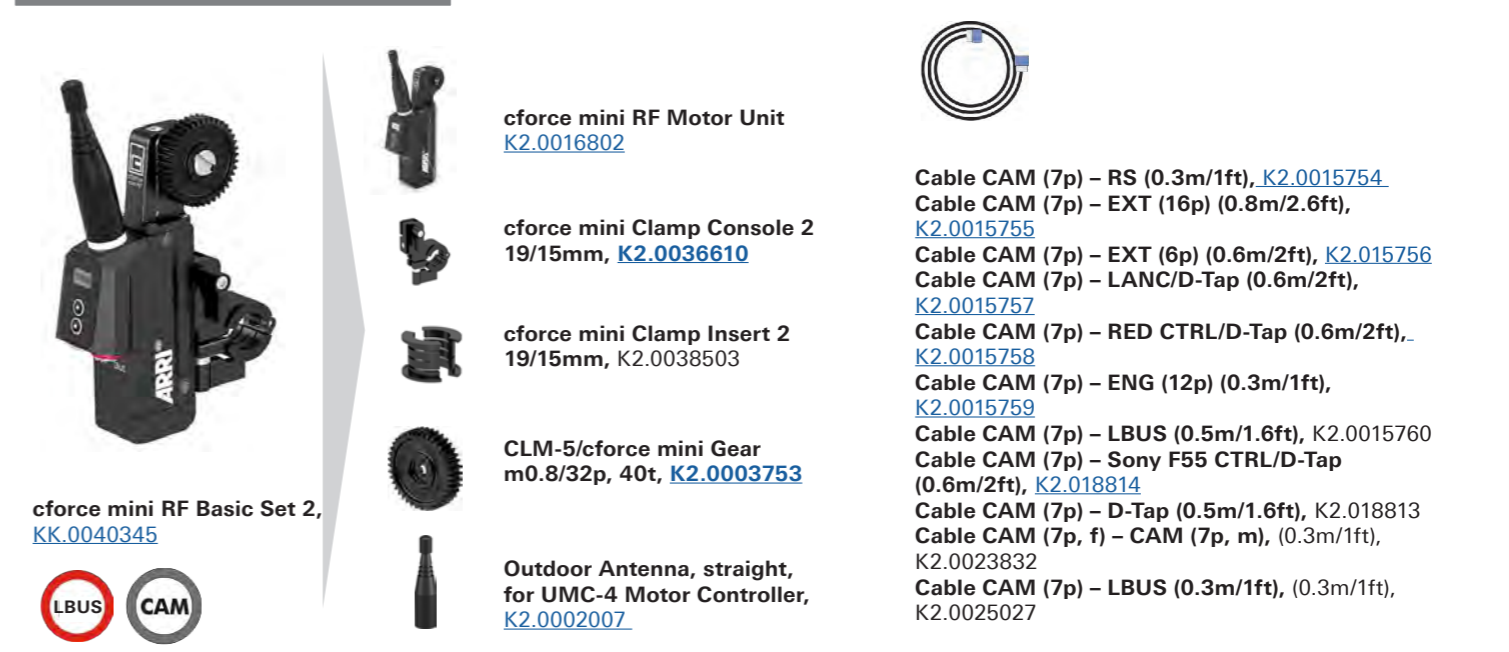

ALEXA Mini LF Multicam - Mechanical Accessories Setup



Configuration Overview | 2.5.0 / 2023.11

Mechanical Accessories Setup

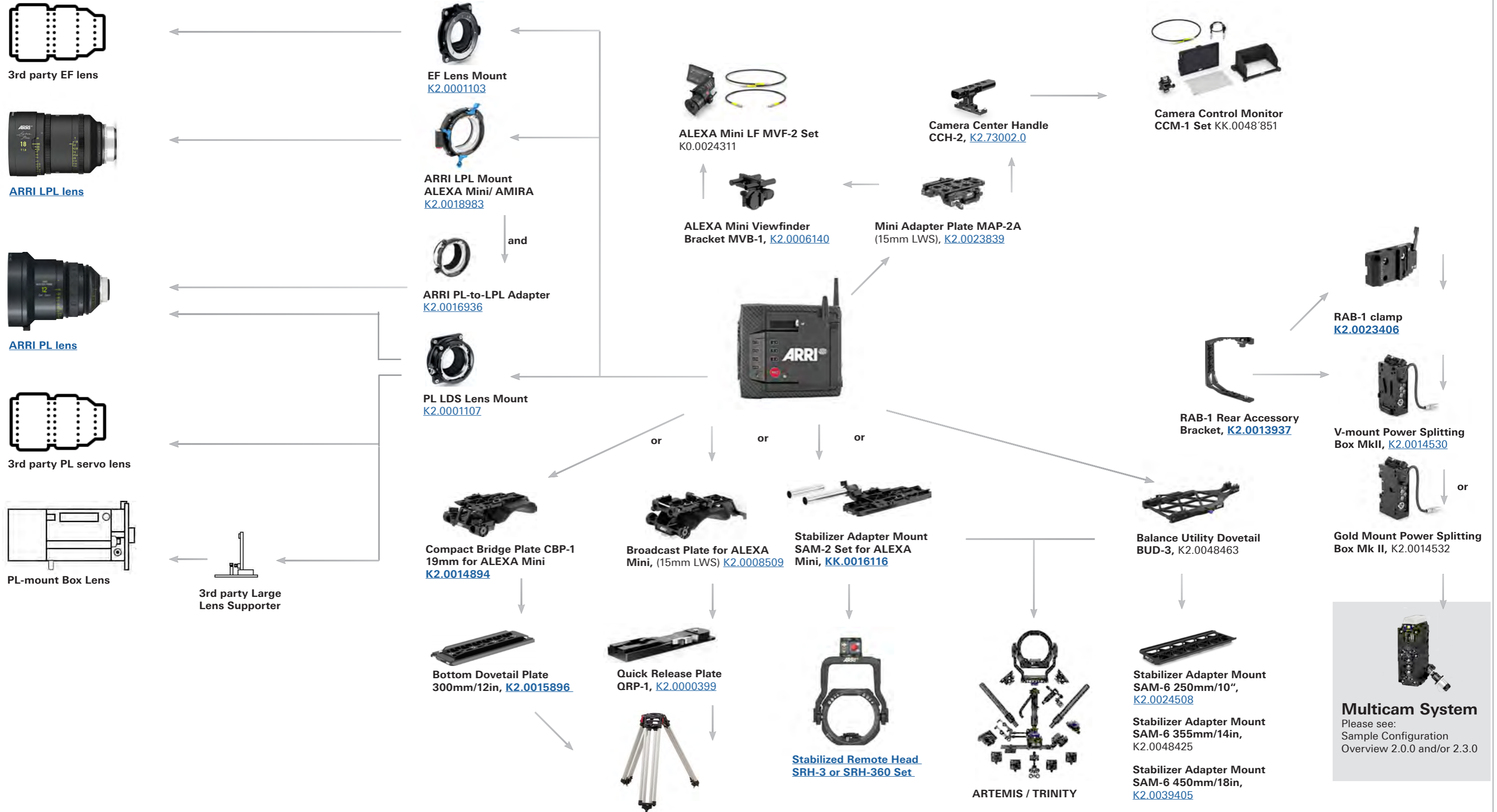

Multicam System
 Please see:
 Sample Configuration
 Overview 2.0.0 and/or 2.3.0

Multicam Alexa Mini LF and Artemis Mechanical - Sample Configuration



Configuration Overview | 2.5.1 / 2023.11

Broadcast Configuration



ALEXA Mini Multicam - Mechanical Accessories Setup



Configuration Overview | 2.6.0 / 2023.11

Mechanical Accessories Setup



3rd party EF lens



ARRI LPL lens



ARRI PL lens



3rd party PL servo lens



B4 ENG/EFP Lens



EF Lens Mount
K2.0001103



ARRI LPL Mount
ALEXA Mini/ AMIRA
K2.0018983



ARRI PL-to-LPL Adapter
K2.0016936



PL LDS Lens Mount
K2.0001107



PL to B4 Lens Adapter
K2.0001238



B4 Lens Mount
K2.0001237



Camera Control Panel
CCP-1 for ALEXA Mini,
K0.00010096
(cable set and L-bracket incl.)



ALEXA Mini Viewfinder
MVF-1, K2.0005861



ALEXA Mini Viewfinder
Bracket MVB-1, K2.0006140

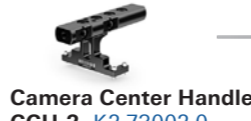

Camera Center Handle
CCH-2, K2.73002.0



Mini Adapter Plate MAP-2A
(15mm LWS), K2.0023839



or



Broadcast Plate for ALEXA
Mini, (15mm LWS) K2.0008509



Stabilizer Adapter Mount
SAM-2 Set for ALEXA
Mini, KK.0016116



Quick Release Plate
QRP-1, K2.0000399



Stabilized Remote Head
SRH-3 or SRH-360 Set



Viewfinder Monitor Multicam
VMM-1, K2.0023813



Monitor Yoke Support MYS-1
K2.0037636



CCP-Live Camera Control
Panel Live Upgrade Set,
KK.0047924

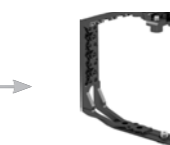

RAB-1 Rear Accessory
Bracket, K2.0013937



RAB-1 clamp
K2.0023406



V-mount Power Splitting
Box MkII, K2.0014530



Gold Mount Power Splitting
Box Mk II, K2.0014532



Multicam System
Please see:
Sample Configuration
Overview 2.0.0 and/or 2.3.0

Multicam ALEXA Mini and Artemis Mechanical - Sample Configuration



Configuration Overview | 2.6.1 / 2023.11

Broadcast Configuration

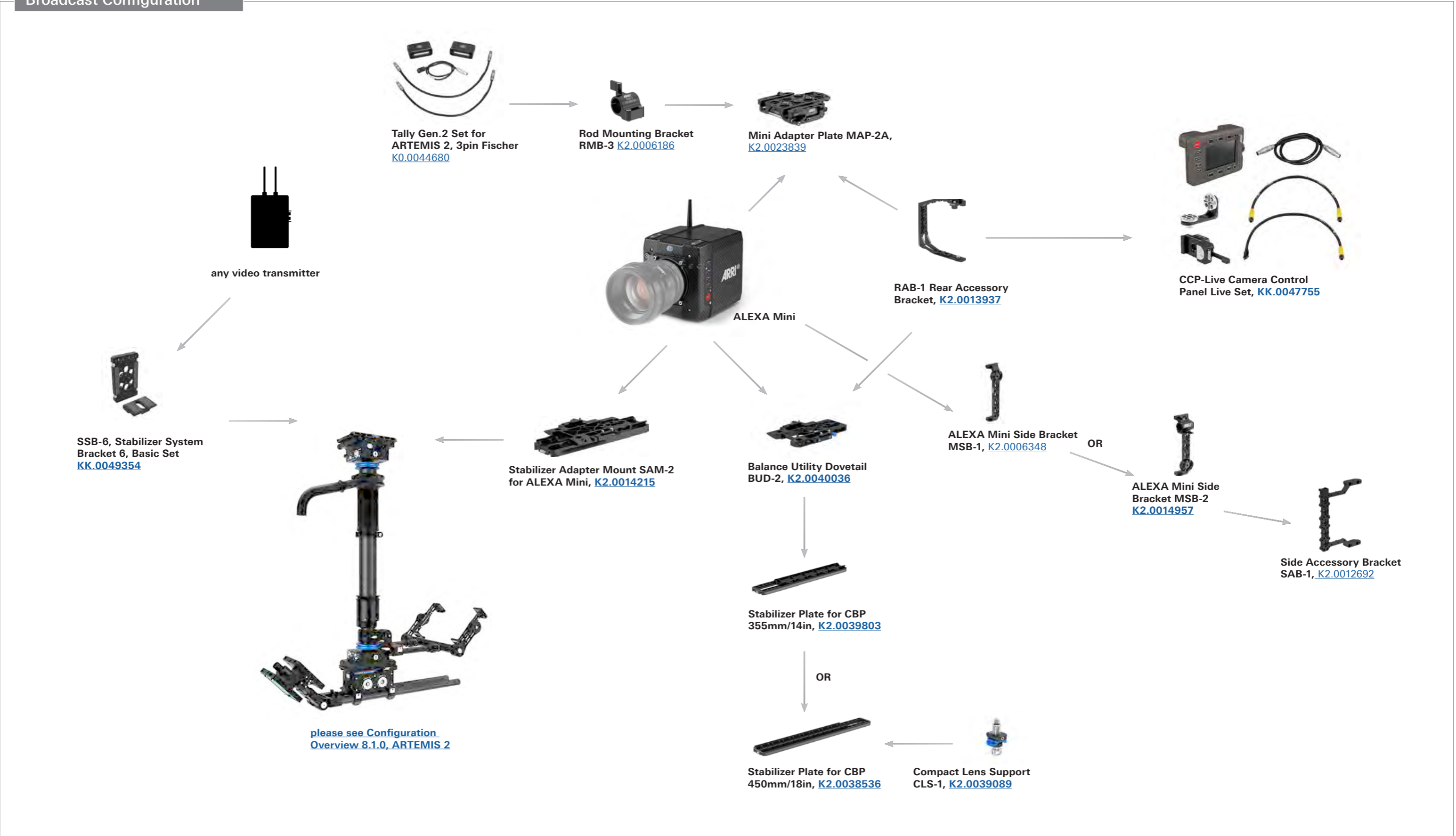

Multicam & Stabilized Remote Heads - Sample Configuration



Configuration Overview | 2.7.0 / 2024.01

Broadcast Configuration

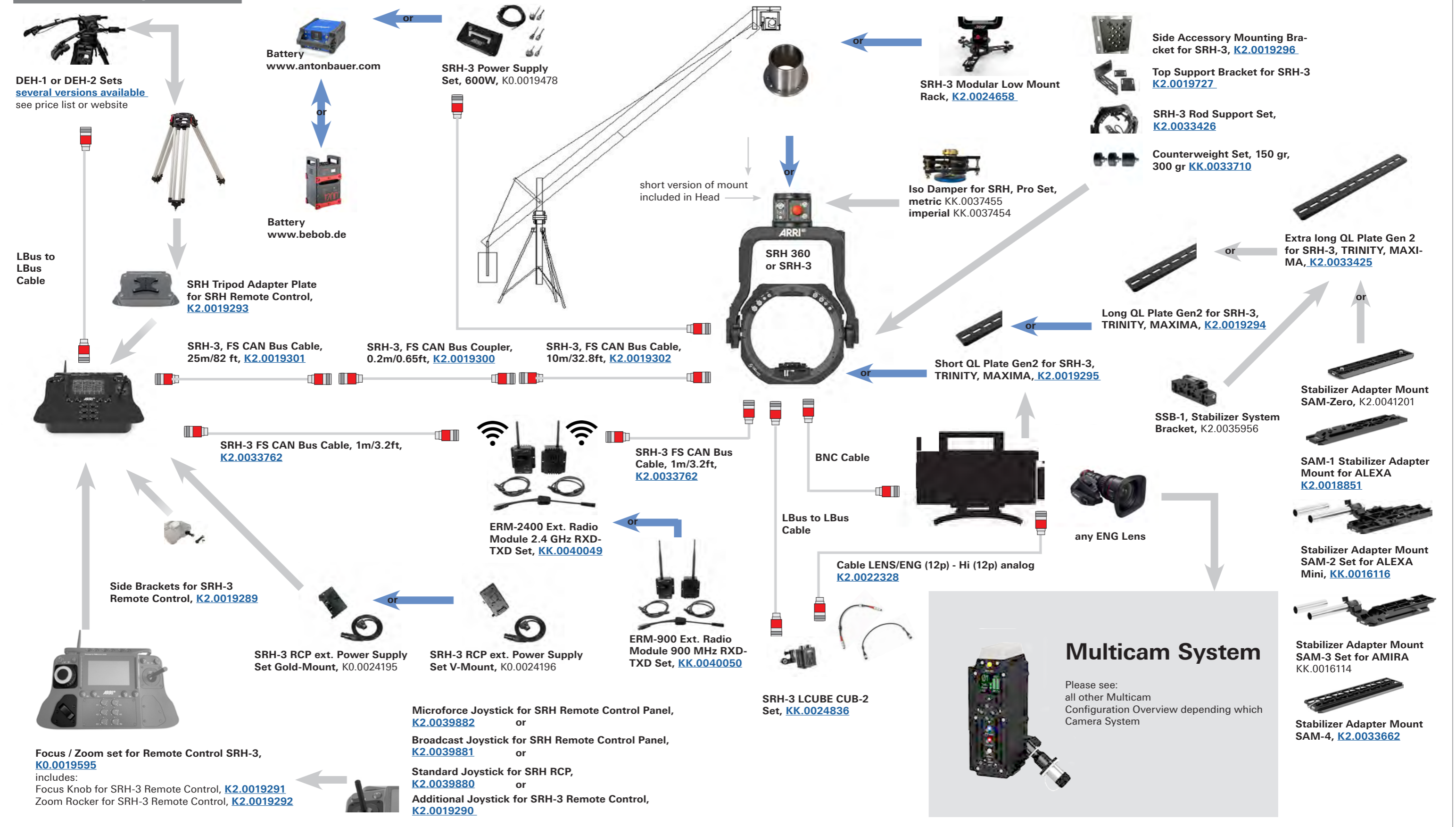

Configuration Overview | 3.1.0 / 2025.09

ARRI Signature Primes

Format: Large Format & SUPER 35

 12 mm T1.8 Ø 134 mm KK.0019185 (m) KK.0019183 (ft)	 15 mm T1.8 Ø 156 mm KK.0019188 (m) KK.0019187 (ft)	 18 mm T1.8 Ø 114 mm KK.0019191 (m) KK.0019189 (ft)	 21 mm T1.8 Ø 114 mm KK.0019193 (m) KK.0019192 (ft)	 25 mm T1.8 Ø 114 mm KK.0019196 (m) KK.0019194 (ft)	 29 mm T1.8 Ø 114 mm KK.0019199 (m) KK.0019197 (ft)
 35 mm T1.8 Ø 114 mm KK.0019102 (m) KK.0019099 (ft)	 40 mm T1.8 Ø 114 mm KK.0019201 (m) KK.0019200 (ft)	 47 mm T1.8 Ø 114 mm KK.0019105 (m) KK.0019104 (ft)	 58 mm T1.8 Ø 114 mm KK.0019203 (m) KK.0019202 (ft)	 75 mm T1.8 Ø 114 mm KK.0019107 (m) KK.0019106 (ft)	 95 mm T1.8 Ø 114 mm KK.0019205 (m) KK.0019204 (ft)
 125 mm T1.8 Ø 114 mm KK.0019109 (m) KK.0019108 (ft)	 150 mm T1.8 Ø 114 mm KK.0019207 (m) KK.0019206 (ft)	 200 mm T2.5 Ø 114 mm KK.0019210 (m) KK.0019209 (ft)	 280 mm T2.8 Ø 134 mm KK.0019213 (m) KK.0019211 (ft) compatible with Signature Zoom Extender 1.7x	<p>ARRI LPL Mount Lens Rear Cap Extended, K2.0020097 ARRI Signature Prime Front Cap Ø 156mm, K2.0019316 ARRI Signature Prime Front Cap Ø 134mm, K2.0019314 ARRI Signature Prime Front Cap Ø 114mm, K2.0019308</p>	

ARRI Signature Zooms

Format: Large Format & SUPER 35

 SZ 16-32 mm T2.8 Ø 156 mm KK.0038601 (m) KK.0038602 (ft) ARRI Signature Zoom Front Cap, K2.0019316	 SZ 24-75 mm T2.8 Ø 114 mm KK.0038603 (m) KK.0038604 (ft) ARRI Signature Zoom Front Cap, K2.0019308
 SZ 45-135 mm T2.8 Ø 114 mm KK.0038605 (m) KK.0038606 (ft) ARRI Signature Zoom Front Cap, K2.0019308	 SZ 65-300mm/Extender 1.7x T2.8 Ø 156 mm KK.0038607 (m) KK.0038608 (ft) ARRI Signature Zoom Front Cap, K2.0019316

Matte Box Checker

Find out which matte box you can use with which ARRI lens to avoid vignetting

ARRI Impression V Filters

ARRI Impression V Filter Kit

- [KK.0048312](#), includes:
- 1x ARRI Impression V Aluminum Case
 - 1x ARRI Impression V Filter 070P
 - 1x ARRI Impression V Filter 140P
 - 1x ARRI Impression V Filter 230P
 - 1x ARRI Impression V Filter 330P
 - 1x ARRI Impression V Filter 050N
 - 1x ARRI Impression V Filter 100N
 - 1x ARRI Impression V Filter 200N
 - 1x ARRI Impression V Filter 290N
 - 1x ARRI Impression V Shim Set
 - 1x ARRI Impression V Velcro® Set
 - 1x Torque Screwdriver



- ARRI Impression V 070P Filter Pack, [K2.0048139](#)** includes: 3x ARRI Impression V Filter 070P and 3x ARRI Impression V Velcro® Set
- ARRI Impression V 140P Filter Pack, [K2.0048140](#)** includes: 3x ARRI Impression V Filter 140P and 3x ARRI Impression V Velcro® Set
- ARRI Impression V 230P Filter Pack, [K2.0048141](#)** includes: 3x ARRI Impression V Filter 230P and 3x ARRI Impression V Velcro® Set
- ARRI Impression V 330P Filter Pack, [K2.0048142](#)** includes: 3x ARRI Impression V Filter 330P and 3x ARRI Impression V Velcro® Set

- ARRI Impression V Shim Pack, [K2.0048147](#)** includes: 6x ARRI Impression V Shim Set
- ARRI Impression V Velcro® Pack, [K2.0048148](#)** includes: 6x ARRI Impression V Velcro® Set



- ARRI Impression V 050N Filter Pack, [K2.0048143](#)** Includes: 3x ARRI Impression V Filter 050N and 1x ARRI Impression V Shim Set and 2x ARRI Impression V Velcro® Set
- ARRI Impression V 100N Filter Pack, [K2.0048144](#)** includes: 3x ARRI Impression V Filter 100N and 1x ARRI Impression V Shim Set and 2x ARRI Impression V Velcro® Set
- ARRI Impression V 200N Filter Pack, [K2.0048145](#)** includes: 3x ARRI Impression V Filter 200N and 1x ARRI Impression V Shim Set and 2x ARRI Impression V Velcro® Set
- ARRI Impression V 290N Filter Pack, [K2.0048146](#)** includes: 3x ARRI Impression V Filter 290N and 1x ARRI Impression V Shim Set and 2x ARRI Impression V Velcro® Set

ARRI Impression V Filters are compatible with ARRI ALEXA 35 / ALEXA Mini LF / ALEXA LF / ALEXA 65 / ALEXA Classic / ALEXA XT / ALEXA SXT.
ARRI Impression V Filters are not compatible with ALEXA Mini and AMIRA. 3rd party cameras and adapters need to be checked

ARRI Signature Zoom Extender



ARRI Signature Zoom Extender 1.7x

[KK.0038609](#)
Extender included in Signature Zoom 65-300mm KK-Sets
SZ 65-300/T2.8 & Extender 1.7x --> 110-510/T4.9
Extender also compatible with Signature Prime SP 280 SP 280/T2.8 & Extender 1.7x --> 480/T4.9

Front Cap, [K5.0015461](#)



Magnetic Rear Filter Holder

[K2.0019522](#)
fits Signature Primes, Signature Zooms & Signature Zoom Extender 1.7x
included with each Signature lens / extender

LPL Large Positive Lock - Compatibility Chart ARRI Models and 3rd Party Adapters



Configuration Overview | 3.1.1 / 2025.01

LPL Compatibility

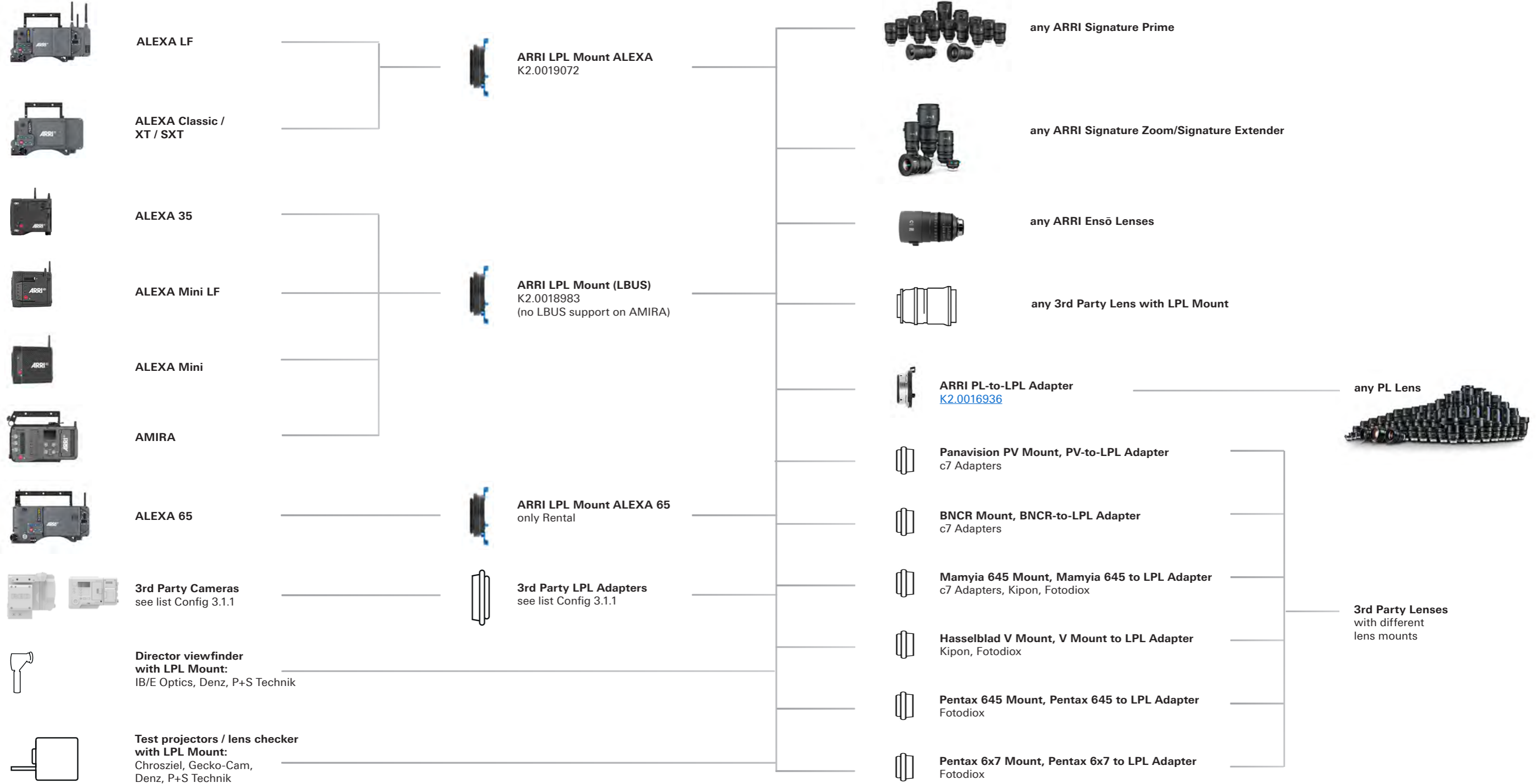

LPL Large Positive Lock - Compatibility Chart 3rd Party



Configuration Overview | 3.1.2 / 2025.01

3rd Party Camera Models	Camera Lens Mount Interface	Required Camera Mount Adapter <small>*native LPL camera mount</small>	Lens Mount (lens-side)	3rd Party LPL-Lens Mount Adapter Manufacturer						
				c7 Adapter	Wooden Camera	KipperTie	Kipon	FotodioX	Vocas	Leitz
Phantom Flex Phantom Flex 4K Phantom VEO 4K	Phantom Flex Phantom Flex Phantom Flex	LPL-Phantom Flex Mount LPL-Phantom Flex Mount LPL-Phantom Flex Mount	any LPL mount lens any LPL mount lens any LPL mount lens	✓ ✓ ✓						
RED Weapon RED Epic RED Scarlet Dragon RED Epic/Scarlet W RED Epic/Scarlet M-X RED Gemini RED Monstro RED Helium	RED DSMC2 RED DSMC2 RED DSMC2 RED DSMC2 RED DSMC2 RED DSMC2 RED DSMC2 RED DSMC2	LPL-RED DSMC2 Mount LPL-RED DSMC2 Mount LPL-RED DSMC2 Mount LPL-RED DSMC2 Mount LPL-RED DSMC2 Mount LPL-RED DSMC2 Mount LPL-RED DSMC2 Mount LPL-RED DSMC2 Mount	any LPL mount lens any LPL mount lens any LPL mount lens any LPL mount lens any LPL mount lens any LPL mount lens any LPL mount lens any LPL mount lens	✓ ✓ ✓ ✓ ✓ ✓ ✓ ✓	✓ ✓ ✓ ✓ ✓ ✓ ✓ ✓	✓ ✓ ✓ ✓ ✓ ✓ ✓ ✓	✓ ✓ ✓ ✓ ✓ ✓ ✓ ✓			
RED Ranger RED Raptor	RED Ranger Canon RF	LPL-RED Ranger LPL-RED Ranger	any LPL mount lens any LPL mount lens	✓ ✓	✓ ✓	✓ ✓	✓ ✓			
RED Komodo Canon EOS R Canon EOS RP Canon EOS R5	Canon RF Canon RF Canon RF Canon RF	LPL-Canon RF LPL-Canon RF LPL-Canon RF LPL-Canon RF	any LPL mount lens any LPL mount lens any LPL mount lens any LPL mount lens	✓ ✓ ✓ ✓	✓ ✓ ✓ ✓	✓ ✓ ✓ ✓	✓ ✓ ✓ ✓			
Sony Venice / Sony Venice 2	Sony Venice	LPL-Sony Venice	any LPL mount lens	✓	✓	✓	✓		✓	✓
Sony FS7 / Sony FS5 Sony FS100 Sony FS700 Sony EA50E Sony VG900 Sony A7 / A7 II / A7 III / A7 IV Sony A7S / A7S II / A7S III Sony A7R / A7R II / A7RIII Sony A7R IV / A7R V Sony A9 Sony A6300 / A5100 Sony A5000 / A6000 Sony A3000 Sony NEX-5 / NEX-6 Sony NEX-3 / NEX-7	Sony E Mount Sony E Mount Sony E Mount Sony E Mount Sony E Mount Sony E Mount Sony E Mount Sony E Mount Sony E Mount Sony E Mount Sony E Mount Sony E Mount Sony E Mount Sony E Mount Sony E Mount Sony E Mount Sony E Mount Sony E Mount Sony E Mount	LPL-Sony E Mount LPL-Sony E Mount LPL-Sony E Mount LPL-Sony E Mount LPL-Sony E Mount LPL-Sony E Mount LPL-Sony E Mount LPL-Sony E Mount LPL-Sony E Mount LPL-Sony E Mount LPL-Sony E Mount LPL-Sony E Mount LPL-Sony E Mount LPL-Sony E Mount LPL-Sony E Mount LPL-Sony E Mount LPL-Sony E Mount LPL-Sony E Mount LPL-Sony E Mount	any LPL mount lens any LPL mount lens any LPL mount lens any LPL mount lens any LPL mount lens any LPL mount lens any LPL mount lens any LPL mount lens any LPL mount lens any LPL mount lens any LPL mount lens any LPL mount lens any LPL mount lens any LPL mount lens any LPL mount lens any LPL mount lens any LPL mount lens any LPL mount lens any LPL mount lens	✓ ✓ ✓ ✓ ✓ ✓ ✓ ✓ ✓ ✓ ✓ ✓ ✓ ✓ ✓ ✓ ✓ ✓ ✓ ✓	✓ ✓ ✓ ✓ ✓ ✓ ✓ ✓ ✓ ✓ ✓ ✓ ✓ ✓ ✓ ✓ ✓ ✓ ✓ ✓	✓ ✓ ✓ ✓ ✓ ✓ ✓ ✓ ✓ ✓ ✓ ✓ ✓ ✓ ✓ ✓ ✓ ✓ ✓ ✓	✓ ✓ ✓ ✓ ✓ ✓ ✓ ✓ ✓ ✓ ✓ ✓ ✓ ✓ ✓ ✓ ✓ ✓ ✓ ✓			
Nikon Z6, Nikon Z7 Nikon Z8, Nikon Z9	Nikon Z Mount Nikon Z Mount	LPL-Nikon Z Mount LPL-Nikon Z Mount	any LPL mount lens any LPL mount lens	✓ ✓				✓ ✓		
Leica SL Leica TL / Leica TL 2 Leica T / Leica CL Panasonic Lumix S1 Panasonic Lumix S1R Panasonic Lumix S1H Panasonic Lumix S5 Sigma FP	Leica L Mount Leica L Mount Leica L Mount Leica L Mount Leica L Mount Leica L Mount Leica L Mount Leica L Mount	LPL-Leica L Mount LPL-Leica L Mount LPL-Leica L Mount LPL-Leica L Mount LPL-Leica L Mount LPL-Leica L Mount LPL-Leica L Mount LPL-Leica L Mount	any LPL mount lens any LPL mount lens any LPL mount lens any LPL mount lens any LPL mount lens any LPL mount lens any LPL mount lens any LPL mount lens	✓ ✓ ✓ ✓ ✓ ✓ ✓ ✓	✓ ✓ ✓ ✓ ✓ ✓ ✓ ✓	✓ ✓ ✓ ✓ ✓ ✓ ✓ ✓	✓ ✓ ✓ ✓ ✓ ✓ ✓ ✓	✓ ✓ ✓ ✓ ✓ ✓ ✓ ✓		✓ ✓ ✓ ✓ ✓ ✓ ✓ ✓
GFX 100 / GFX 50S GFX 50R / GFX 100 II	Fuji G Mount Fuji G Mount	LPL-Fuji G Mount LPL-Fuji G Mount	any LPL mount lens any LPL mount lens	✓ ✓	✓ ✓			✓ ✓		
X1D 50c / X1D II 50c	Hasselblad XCD	LPL-XCD Mount	any LPL mount lens					✓		
MAVO / MAVO LF TERRA 4K	Kinefinity Kinefinity	KineMOUNT LPL Mount* KineMOUNT LPL Mount*	any LPL mount lens any LPL mount lens							
Achtel 9x7 DCC	9x7 DCC	9x7 DCC LPL Mount*	any LPL mount lens							

5x Signature Primes with ALEXA Mini LF Ready to Shoot Sets



Configuration Overview | 3.1.4 / 2022.11

5x Signature Primes



random pictures

Ready to Shoot Set B-Mount

5x Signature Primes (M) & ALEXA Mini LF Ready to Shoot Set B, K0.0048012

includes:
[KK.0019196](#) ARRI Signature Prime 25/T1.8 **M**
[KK.0019102](#) ARRI Signature Prime 35/T1.8 **M**
[KK.0019105](#) ARRI Signature Prime 47/T1.8 **M**
[KK.0019107](#) ARRI Signature Prime 75/T1.8 **M**
[KK.0019109](#) ARRI Signature Prime 125/T1.8 **M**
 K1.0024074 1x ALEXA Mini LF camera body
 K2.0018983 1x ARRI LPL Mount (LBUS)
[K2.0016936](#) 1x ARRI PL-to-LPL Adapter
 K2.0024130 2x CODEX Compact Drive 1TB (CA08-1024)
 K2.0020916 1x Multi Viewfinder MVF-2
 K2.0023915 1x Cable VF (0.35m/1.15ft)
 K2.0023943 1x Cable VF (0.5m/1.5ft)
 K2.0023839 1x Mini Adapter Plate MAP-2A
 K2.0006140 1x Mini Viewfinder Bracket MVB-1
 K2.73002.0 1x Center Camera Handle CCH-2
 K2.0023546 1x Mini Side Bracket MSB-3
 K2.0014957 1x Mini Side Bracket MSB-2
 K2.0014894 1x Compact Bridge Plate CBP-1 **19mm**
 K2.0013937 1x Rear Accessory Bracket RAB-1
 K2.0023406 1x RAB-1 Clamp 2
 K2.0006186 1x Rod Mounting Bracket RMB-3
 K2.66255.0 1x 15mm Reduction Insert
 K2.0024114 1x **B-Mount Power Splitting Box**
 K2.0015896 1x Bottom Dovetail Plate 300mm/12in
 K2.75007.0 1x Camera Power Cable Straight 2m/6.6in KC50

Ready to Shoot Set V-Mount

5x Signature Primes (M) & ALEXA Mini LF Ready to Shoot Set V, K0.0048014

includes:
[KK.0019196](#) ARRI Signature Prime 25/T1.8 **M**
[KK.0019102](#) ARRI Signature Prime 35/T1.8 **M**
[KK.0019105](#) ARRI Signature Prime 47/T1.8 **M**
[KK.0019107](#) ARRI Signature Prime 75/T1.8 **M**
[KK.0019109](#) ARRI Signature Prime 125/T1.8 **M**
 K1.0024074 1x ALEXA Mini LF camera body
 K2.0018983 1x ARRI LPL Mount (LBUS)
[K2.0016936](#) 1x ARRI PL-to-LPL Adapter
 K2.0024130 2x CODEX Compact Drive 1TB (CA08-1024)
 K2.0020916 1x Multi Viewfinder MVF-2
 K2.0023915 1x Cable VF (0.35m/1.15ft)
 K2.0023943 1x Cable VF (0.5m/1.5ft)
 K2.0023839 1x Mini Adapter Plate MAP-2A
 K2.0006140 1x Mini Viewfinder Bracket MVB-1
 K2.73002.0 1x Center Camera Handle CCH-2
 K2.0023546 1x Mini Side Bracket MSB-3
 K2.0014957 1x Mini Side Bracket MSB-2
 K2.0014894 1x Compact Bridge Plate CBP-1 **19mm**
 K2.0013937 1x Rear Accessory Bracket RAB-1
 K2.0023406 1x RAB-1 Clamp 2
 K2.0006186 1x Rod Mounting Bracket RMB-3
 K2.66255.0 1x 15mm Reduction Insert
 K2.0014530 1x **V-Mount Power Splitting Box MkII**
 K2.0015896 1x Bottom Dovetail Plate 300mm/12in
 K2.75007.0 1x Camera Power Cable Straight 2m/6.6in KC-50

Ready to Shoot Set Gold-Mount

5x Signature Primes (M) & ALEXA Mini LF Ready to Shoot Set Gold, K0.0048013

includes:
[KK.0019196](#) ARRI Signature Prime 25/T1.8 **M**
[KK.0019102](#) ARRI Signature Prime 35/T1.8 **M**
[KK.0019105](#) ARRI Signature Prime 47/T1.8 **M**
[KK.0019107](#) ARRI Signature Prime 75/T1.8 **M**
[KK.0019109](#) ARRI Signature Prime 125/T1.8 **M**
 K1.0024074 1x ALEXA Mini LF camera body
 K2.0018983 1x ARRI LPL Mount (LBUS)
[K2.0016936](#) 1x ARRI PL-to-LPL Adapter
 K2.0024130 2x CODEX Compact Drive 1TB (CA08-1024)
 K2.0020916 1x Multi Viewfinder MVF-2
 K2.0023915 1x Cable VF (0.35m/1.15ft)
 K2.0023943 1x Cable VF (0.5m/1.5ft)
 K2.0023839 1x Mini Adapter Plate MAP-2A
 K2.0006140 1x Mini Viewfinder Bracket MVB-1
 K2.73002.0 1x Center Camera Handle CCH-2
 K2.0023546 1x Mini Side Bracket MSB-3
 K2.0014957 1x Mini Side Bracket MSB-2
 K2.0014894 1x Compact Bridge Plate CBP-1 **19mm**
 K2.0013937 1x Rear Accessory Bracket RAB-1
 K2.0023406 1x RAB-1 Clamp 2
 K2.0006186 1x Rod Mounting Bracket RMB-3
 K2.66255.0 1x 15mm Reduction Insert
 K2.0014532 1x **Gold Mount Power Splitting Box Mk II**
 K2.0015896 1x Bottom Dovetail Plate 300mm/12in
 K2.75007.0 1x Camera Power Cable Straight 2m/6.6in KC-50

ALEXA Mini LF Ready to Shoot Set



5x Signature Primes (F) & ALEXA Mini LF Ready to Shoot Set B, K0.0048007

includes:
[KK.0019194](#) ARRI Signature Prime 25/T1.8 **F**
[KK.0019099](#) ARRI Signature Prime 35/T1.8 **F**
[KK.0019104](#) ARRI Signature Prime 47/T1.8 **F**
[KK.0019106](#) ARRI Signature Prime 75/T1.8 **F**
[KK.0019108](#) ARRI Signature Prime 125/T1.8 **F**
 K1.0024074 1x ALEXA Mini LF camera body
 K2.0018983 1x ARRI LPL Mount (LBUS)
[K2.0016936](#) 1x ARRI PL-to-LPL Adapter
 K2.0024130 2x CODEX Compact Drive 1TB (CA08-1024)
 K2.0020916 1x Multi Viewfinder MVF-2
 K2.0023915 1x Cable VF (0.35m/1.15ft)
 K2.0023943 1x Cable VF (0.5m/1.5ft)
 K2.0023839 1x Mini Adapter Plate MAP-2A
 K2.0006140 1x Mini Viewfinder Bracket MVB-1
 K2.73002.0 1x Center Camera Handle CCH-2
 K2.0023546 1x Mini Side Bracket MSB-3
 K2.0014957 1x Mini Side Bracket MSB-2
 K2.0014894 1x Compact Bridge Plate CBP-1 **19mm**
 K2.0013937 1x Rear Accessory Bracket RAB-1
 K2.0023406 1x RAB-1 Clamp 2
 K2.0006186 1x Rod Mounting Bracket RMB-3
 K2.66255.0 1x 15mm Reduction Insert
 K2.0024114 1x **B-Mount Power Splitting Box**
 K2.0015896 1x Bottom Dovetail Plate 300mm/12in
 K2.75007.0 1x Camera Power Cable Straight 2m/6.6in KC-50

5x Signature Primes (F) & ALEXA Mini LF Ready to Shoot Set V, K0.0048009

includes:
[KK.0019194](#) ARRI Signature Prime 25/T1.8 **F**
[KK.0019099](#) ARRI Signature Prime 35/T1.8 **F**
[KK.0019104](#) ARRI Signature Prime 47/T1.8 **F**
[KK.0019106](#) ARRI Signature Prime 75/T1.8 **F**
[KK.0019108](#) ARRI Signature Prime 125/T1.8 **F**
 K1.0024074 1x ALEXA Mini LF camera body
 K2.0018983 1x ARRI LPL Mount (LBUS)
[K2.0016936](#) 1x ARRI PL-to-LPL Adapter
 K2.0024130 2x CODEX Compact Drive 1TB (CA08-1024)
 K2.0020916 1x Multi Viewfinder MVF-2
 K2.0023915 1x Cable VF (0.35m/1.15ft)
 K2.0023943 1x Cable VF (0.5m/1.5ft)
 K2.0023839 1x Mini Adapter Plate MAP-2A
 K2.0006140 1x Mini Viewfinder Bracket MVB-1
 K2.73002.0 1x Center Camera Handle CCH-2
 K2.0023546 1x Mini Side Bracket MSB-3
 K2.0014957 1x Mini Side Bracket MSB-2
 K2.0014894 1x Compact Bridge Plate CBP-1 **19mm**
 K2.0013937 1x Rear Accessory Bracket RAB-1
 K2.0023406 1x RAB-1 Clamp 2
 K2.0006186 1x Rod Mounting Bracket RMB-3
 K2.66255.0 1x 15mm Reduction Insert
 K2.0014530 1x **V-Mount Power Splitting Box MkII**
 K2.0015896 1x Bottom Dovetail Plate 300mm/12in
 K2.75007.0 1x Camera Power Cable Straight 2m/6.6in KC-50

5x Signature Primes (F) & ALEXA Mini LF Ready to Shoot Set Gold, K0.0048008

includes:
[KK.0019194](#) ARRI Signature Prime 25/T1.8 **F**
[KK.0019099](#) ARRI Signature Prime 35/T1.8 **F**
[KK.0019104](#) ARRI Signature Prime 47/T1.8 **F**
[KK.0019106](#) ARRI Signature Prime 75/T1.8 **F**
[KK.0019108](#) ARRI Signature Prime 125/T1.8 **F**
 K1.0024074 1x ALEXA Mini LF camera body
 K2.0018983 1x ARRI LPL Mount (LBUS)
[K2.0016936](#) 1x ARRI PL-to-LPL Adapter
 K2.0024130 2x CODEX Compact Drive 1TB (CA08-1024)
 K2.0020916 1x Multi Viewfinder MVF-2
 K2.0023915 1x Cable VF (0.35m/1.15ft)
 K2.0023943 1x Cable VF (0.5m/1.5ft)
 K2.0023839 1x Mini Adapter Plate MAP-2A
 K2.0006140 1x Mini Viewfinder Bracket MVB-1
 K2.73002.0 1x Center Camera Handle CCH-2
 K2.0023546 1x Mini Side Bracket MSB-3
 K2.0014957 1x Mini Side Bracket MSB-2
 K2.0014894 1x Compact Bridge Plate CBP-1 **19mm**
 K2.0013937 1x Rear Accessory Bracket RAB-1
 K2.0023406 1x RAB-1 Clamp 2
 K2.0006186 1x Rod Mounting Bracket RMB-3
 K2.66255.0 1x 15mm Reduction Insert
 K2.0014532 1x **Gold Mount Power Splitting Box Mk II**
 K2.0015896 1x Bottom Dovetail Plate 300mm/12in
 K2.75007.0 1x Camera Power Cable Straight 2m/6.6in KC-50

8x Signature Primes with ALEXA Mini LF Ready to Shoot Sets



Configuration Overview | 3.1.5 / 2023.11

8x Signature Primes



random pictures

Ready to Shoot Set B-Mount

8x Signature Primes (M) & ALEXA Mini LF Ready to Shoot Set B, K0.0048022

- includes:
- [KK.0019191](#) ARRI Signature Prime 18/T1.8 **M**
 - [KK.0019196](#) ARRI Signature Prime 25/T1.8 **M**
 - [KK.0019102](#) ARRI Signature Prime 35/T1.8 **M**
 - [KK.0019105](#) ARRI Signature Prime 47/T1.8 **M**
 - [KK.0019203](#) ARRI Signature Prime 58/T1.8 **M**
 - [KK.0019107](#) ARRI Signature Prime 75/T1.8 **M**
 - [KK.0019109](#) ARRI Signature Prime 125/T1.8 **M**
 - [KK.0019210](#) ARRI Signature Prime 200/T2.5 **M**
 - K1.0024074 1x ALEXA Mini LF camera body
 - K2.0018983 1x ARRI LPL Mount (LBUS)
 - [K2.0016936](#) 1x ARRI PL-to-LPL Adapter
 - K2.0024130 2x CODEX Compact Drive 1TB (CA08-1024)
 - K2.0020916 1x Multi Viewfinder MVF-2
 - K2.0023915 1x Cable VF (0.35m/1.15ft)
 - K2.0023943 1x Cable VF (0.5m/1.5ft)
 - K2.0023839 1x Mini Adapter Plate MAP-2A
 - K2.0006140 1x Mini Viewfinder Bracket MVB-1
 - K2.73002.0 1x Center Camera Handle CCH-2
 - K2.0023546 1x Mini Side Bracket MSB-3
 - K2.0014957 1x Mini Side Bracket MSB-2
 - K2.0014894 1x Compact Bridge Plate CBP-1 **19mm**
 - K2.0013937 1x Rear Accessory Bracket RAB-1
 - K2.0023406 1x RAB-1 Clamp 2
 - K2.0006186 1x Rod Mounting Bracket RMB-3
 - K2.66255.0 1x 15mm Reduction Insert
 - K2.0024114 1x **B-Mount Power Splitting Box**
 - K2.0015896 1x Bottom Dovetail Plate 300mm/12in
 - K2.75007.0 1x Camera Power Cable Straight 2m/6.6in KC50

Ready to Shoot Set V-Mount

8x Signature Primes (M) & ALEXA Mini LF Ready to Shoot Set V, K0.0048024

- includes:
- [KK.0019191](#) ARRI Signature Prime 18/T1.8 **M**
 - [KK.0019196](#) ARRI Signature Prime 25/T1.8 **M**
 - [KK.0019102](#) ARRI Signature Prime 35/T1.8 **M**
 - [KK.0019105](#) ARRI Signature Prime 47/T1.8 **M**
 - [KK.0019203](#) ARRI Signature Prime 58/T1.8 **M**
 - [KK.0019107](#) ARRI Signature Prime 75/T1.8 **M**
 - [KK.0019109](#) ARRI Signature Prime 125/T1.8 **M**
 - [KK.0019210](#) ARRI Signature Prime 200/T2.5 **M**
 - K1.0024074 1x ALEXA Mini LF camera body
 - K2.0018983 1x ARRI LPL Mount (LBUS)
 - [K2.0016936](#) 1x ARRI PL-to-LPL Adapter
 - K2.0024130 2x CODEX Compact Drive 1TB (CA08-1024)
 - K2.0020916 1x Multi Viewfinder MVF-2
 - K2.0023915 1x Cable VF (0.35m/1.15ft)
 - K2.0023943 1x Cable VF (0.5m/1.5ft)
 - K2.0023839 1x Mini Adapter Plate MAP-2A
 - K2.0006140 1x Mini Viewfinder Bracket MVB-1
 - K2.73002.0 1x Center Camera Handle CCH-2
 - K2.0023546 1x Mini Side Bracket MSB-3
 - K2.0014957 1x Mini Side Bracket MSB-2
 - K2.0014894 1x Compact Bridge Plate CBP-1 **19mm**
 - K2.0013937 1x Rear Accessory Bracket RAB-1
 - K2.0023406 1x RAB-1 Clamp 2
 - K2.0006186 1x Rod Mounting Bracket RMB-3
 - K2.66255.0 1x 15mm Reduction Insert
 - K2.0014530 1x **V-Mount Power Splitting Box MkII**
 - K2.0015896 1x Bottom Dovetail Plate 300mm/12in
 - K2.75007.0 1x Camera Power Cable Straight 2m/6.6in KC-50

Ready to Shoot Set Gold-Mount

8x Signature Primes (M) & ALEXA Mini LF Ready to Shoot Set Gold, K0.0048023

- includes:
- [KK.0019191](#) ARRI Signature Prime 18/T1.8 **M**
 - [KK.0019196](#) ARRI Signature Prime 25/T1.8 **M**
 - [KK.0019102](#) ARRI Signature Prime 35/T1.8 **M**
 - [KK.0019105](#) ARRI Signature Prime 47/T1.8 **M**
 - [KK.0019203](#) ARRI Signature Prime 58/T1.8 **M**
 - [KK.0019107](#) ARRI Signature Prime 75/T1.8 **M**
 - [KK.0019109](#) ARRI Signature Prime 125/T1.8 **M**
 - [KK.0019210](#) ARRI Signature Prime 200/T2.5 **M**
 - K1.0024074 1x ALEXA Mini LF camera body
 - K2.0018983 1x ARRI LPL Mount (LBUS)
 - [K2.0016936](#) 1x ARRI PL-to-LPL Adapter
 - K2.0024130 2x CODEX Compact Drive 1TB (CA08-1024)
 - K2.0020916 1x Multi Viewfinder MVF-2
 - K2.0023915 1x Cable VF (0.35m/1.15ft)
 - K2.0023943 1x Cable VF (0.5m/1.5ft)
 - K2.0023839 1x Mini Adapter Plate MAP-2A
 - K2.0006140 1x Mini Viewfinder Bracket MVB-1
 - K2.73002.0 1x Center Camera Handle CCH-2
 - K2.0023546 1x Mini Side Bracket MSB-3
 - K2.0014957 1x Mini Side Bracket MSB-2
 - K2.0014894 1x Compact Bridge Plate CBP-1 **19mm**
 - K2.0013937 1x Rear Accessory Bracket RAB-1
 - K2.0023406 1x RAB-1 Clamp 2
 - K2.0006186 1x Rod Mounting Bracket RMB-3
 - K2.66255.0 1x 15mm Reduction Insert
 - K2.0014532 1x **Gold Mount Power Splitting Box Mk II**
 - K2.0015896 1x Bottom Dovetail Plate 300mm/12in
 - K2.75007.0 1x Camera Power Cable Straight 2m/6.6in KC-50

ALEXA Mini LF Ready to Shoot Set



8x Signature Primes (F) & ALEXA Mini LF Ready to Shoot Set B, K0.0048017

- includes:
- [KK.0019189](#) ARRI Signature Prime 18/T1.8 **F**
 - [KK.0019194](#) ARRI Signature Prime 25/T1.8 **F**
 - [KK.0019099](#) ARRI Signature Prime 35/T1.8 **F**
 - [KK.0019104](#) ARRI Signature Prime 47/T1.8 **F**
 - [KK.0019202](#) ARRI Signature Prime 58/T1.8 **F**
 - [KK.0019106](#) ARRI Signature Prime 75/T1.8 **F**
 - [KK.0019108](#) ARRI Signature Prime 125/T1.8 **F**
 - [KK.0019209](#) ARRI Signature Prime 200/T2.5 **F**
 - K1.0024074 1x ALEXA Mini LF camera body
 - K2.0018983 1x ARRI LPL Mount (LBUS)
 - [K2.0016936](#) 1x ARRI PL-to-LPL Adapter
 - K2.0024130 2x CODEX Compact Drive 1TB (CA08-1024)
 - K2.0020916 1x Multi Viewfinder MVF-2
 - K2.0023915 1x Cable VF (0.35m/1.15ft)
 - K2.0023943 1x Cable VF (0.5m/1.5ft)
 - K2.0023839 1x Mini Adapter Plate MAP-2A
 - K2.0006140 1x Mini Viewfinder Bracket MVB-1
 - K2.73002.0 1x Center Camera Handle CCH-2
 - K2.0023546 1x Mini Side Bracket MSB-3
 - K2.0014957 1x Mini Side Bracket MSB-2
 - K2.0014894 1x Compact Bridge Plate CBP-1 **19mm**
 - K2.0013937 1x Rear Accessory Bracket RAB-1
 - K2.0023406 1x RAB-1 Clamp 2
 - K2.0006186 1x Rod Mounting Bracket RMB-3
 - K2.66255.0 1x 15mm Reduction Insert
 - K2.0024114 1x **B-Mount Power Splitting Box**
 - K2.0015896 1x Bottom Dovetail Plate 300mm/12in
 - K2.75007.0 1x Camera Power Cable Straight 2m/6.6in KC-50

8x Signature Primes (F) & ALEXA Mini LF Ready to Shoot Set V, K0.0048019

- includes:
- [KK.0019189](#) ARRI Signature Prime 18/T1.8 **F**
 - [KK.0019194](#) ARRI Signature Prime 25/T1.8 **F**
 - [KK.0019099](#) ARRI Signature Prime 35/T1.8 **F**
 - [KK.0019104](#) ARRI Signature Prime 47/T1.8 **F**
 - [KK.0019202](#) ARRI Signature Prime 58/T1.8 **F**
 - [KK.0019106](#) ARRI Signature Prime 75/T1.8 **F**
 - [KK.0019108](#) ARRI Signature Prime 125/T1.8 **F**
 - [KK.0019209](#) ARRI Signature Prime 200/T2.5 **F**
 - K1.0024074 1x ALEXA Mini LF camera body
 - K2.0018983 1x ARRI LPL Mount (LBUS)
 - [K2.0016936](#) 1x ARRI PL-to-LPL Adapter
 - K2.0024130 2x CODEX Compact Drive 1TB (CA08-1024)
 - K2.0020916 1x Multi Viewfinder MVF-2
 - K2.0023915 1x Cable VF (0.35m/1.15ft)
 - K2.0023943 1x Cable VF (0.5m/1.5ft)
 - K2.0023839 1x Mini Adapter Plate MAP-2A
 - K2.0006140 1x Mini Viewfinder Bracket MVB-1
 - K2.73002.0 1x Center Camera Handle CCH-2
 - K2.0023546 1x Mini Side Bracket MSB-3
 - K2.0014957 1x Mini Side Bracket MSB-2
 - K2.0014894 1x Compact Bridge Plate CBP-1 **19mm**
 - K2.0013937 1x Rear Accessory Bracket RAB-1
 - K2.0023406 1x RAB-1 Clamp 2
 - K2.0006186 1x Rod Mounting Bracket RMB-3
 - K2.66255.0 1x 15mm Reduction Insert
 - K2.0014530 1x **V-Mount Power Splitting Box MkII**
 - K2.0015896 1x Bottom Dovetail Plate 300mm/12in
 - K2.75007.0 1x Camera Power Cable Straight 2m/6.6in KC-50

8x Signature Primes (F) & ALEXA Mini LF Ready to Shoot Set Gold, K0.0048018

- includes:
- [KK.0019189](#) ARRI Signature Prime 18/T1.8 **F**
 - [KK.0019194](#) ARRI Signature Prime 25/T1.8 **F**
 - [KK.0019099](#) ARRI Signature Prime 35/T1.8 **F**
 - [KK.0019104](#) ARRI Signature Prime 47/T1.8 **F**
 - [KK.0019202](#) ARRI Signature Prime 58/T1.8 **F**
 - [KK.0019106](#) ARRI Signature Prime 75/T1.8 **F**
 - [KK.0019108](#) ARRI Signature Prime 125/T1.8 **F**
 - [KK.0019209](#) ARRI Signature Prime 200/T2.5 **F**
 - K1.0024074 1x ALEXA Mini LF camera body
 - K2.0018983 1x ARRI LPL Mount (LBUS)
 - [K2.0016936](#) 1x ARRI PL-to-LPL Adapter
 - K2.0024130 2x CODEX Compact Drive 1TB (CA08-1024)
 - K2.0020916 1x Multi Viewfinder MVF-2
 - K2.0023915 1x Cable VF (0.35m/1.15ft)
 - K2.0023943 1x Cable VF (0.5m/1.5ft)
 - K2.0023839 1x Mini Adapter Plate MAP-2A
 - K2.0006140 1x Mini Viewfinder Bracket MVB-1
 - K2.73002.0 1x Center Camera Handle CCH-2
 - K2.0023546 1x Mini Side Bracket MSB-3
 - K2.0014957 1x Mini Side Bracket MSB-2
 - K2.0014894 1x Compact Bridge Plate CBP-1 **19mm**
 - K2.0013937 1x Rear Accessory Bracket RAB-1
 - K2.0023406 1x RAB-1 Clamp 2
 - K2.0006186 1x Rod Mounting Bracket RMB-3
 - K2.66255.0 1x 15mm Reduction Insert
 - K2.0014532 1x **Gold Mount Power Splitting Box Mk II**
 - K2.0015896 1x Bottom Dovetail Plate 300mm/12in
 - K2.75007.0 1x Camera Power Cable Straight 2m/6.6in KC-50

ARRI Ensō Primes - Core Sets & Kits

Format: Large Format & SUPER 35



ARRI Ensō Prime Core Set (M)

KK.0052482, includes
 KK.0049812 1x ARRI Ensō Prime KIT 18, 24, 32 (M)
 KK.0049814 1x ARRI Ensō Prime KIT 47, 75, 105 (M)
 KK.0049815 1x ARRI Ensō Vintage Elements KIT
 (all in 3 cases)



ARRI Ensō Prime Core Set (F)

KK.0052483, includes
 KK.0049811 1x ARRI Ensō Prime KIT 18, 24, 32 (F)
 KK.0049813 1x ARRI Ensō Prime KIT 47, 75, 105 (F)
 KK.0049815 1x ARRI Ensō Vintage Elements KIT
 (all in 3 cases)



ARRI Ensō Prime Kit 18, 24, 32 (M)

KK.0049812, includes:
 K2.0048083 1x ARRI Ensō Prime 18/T2.1 M
 K2.0048087 1x ARRI Ensō Prime 24/T2.1 M
 K2.0048091 1x ARRI Ensō Prime 32/T2.1 M
 (all in 1 case)
 only available in the Core Set



ARRI Ensō Prime Kit 18, 24, 32 (F)

KK.0049811, includes
 K2.0048082 1x ARRI Ensō Prime 18/T2.1 F
 K2.0048086 1x ARRI Ensō Prime 24/T2.1 F
 K2.0048090 1x ARRI Ensō Prime 32/T2.1 F
 (all in 1 case)
 only available in the Core Set

ARRI Ensō Prime Kit 47, 75, 105 (M)

KK.0049814, includes:
 K2.0048095 1x ARRI Ensō Prime 47/T2.1 M
 K2.0048100 1x ARRI Ensō Prime 75/T2.1 M
 K2.0048102 1x ARRI Ensō Prime 105/T2.1 M
 (all in 1 case)
 only available in the Core Set

ARRI Ensō Prime Kit 47, 75, 105 (F)

KK.0049813, includes:
 K2.0048094 1x ARRI Ensō Prime 47/T2.1 F
 K2.0048098 1x ARRI Ensō Prime 75/T2.1 F
 K2.0048101 1x ARRI Ensō Prime 105/T2.1 F
 (all in 1 case)
 only available in the Core Set



ARRI Ensō Vintage Elements Kit

KK.0049815, includes:
 ARRI Ensō VE 100P / VE 200P / VE 350P / VE 100N / VE 200N / VE 350N
 ARRI Ensō Creative Adapter + Retaining Rings
 ARRI Ensō VE Shim Set
 Adjustable Torque Screwdriver
 ARRI Ensō Retaining Ring Tool
 (all in 1 case)



Matte Box Checker

Find out which matte box you can use with which ARRI lens to avoid vignetting

ARRI Ensō Primes

Format: Large Format & SUPER 35



10.5 mm
 T2.8 | Ø 156 mm,
 Ø 134 mm
KK.0053511 (m)
KK.0053510 (ft)
 incl. single case



14 mm
 T2.5 | Ø 156 mm,
 Ø 134 mm
KK.0053517 (m)
KK.0053516 (ft)
 incl. single case



18 mm
 T2.1 | Ø 95 mm
 K2.0048083 (m)
 K2.0048082 (ft)
 only available in
 the Core Set



21 mm
 T2.1 | Ø 95 mm
KK.0053519 (m)
KK.0053518 (ft)
 incl. single case



24 mm
 T2.1 | Ø 95 mm
 K2.0048087 (m)
 K2.0048086 (ft)
 only available in
 the Core Set



28 mm
 T2.1 | Ø 95 mm
KK.0053521 (m)
KK.0053520 (ft)
 incl. single case



32 mm
 T2.1 | Ø 95 mm
 K2.0048091 (m)
 K2.0048090 (ft)
 only available in
 the Core Set



40 mm
 T2.1 | Ø 95 mm
KK.0053524 (m)
KK.0053522 (ft)
 incl. single case



47 mm
 T2.1 | Ø 95 mm
 K2.0048095 (m)
 K2.0048094 (ft)
 only available in
 the Core Set



58 mm
 T2.1 | Ø 95 mm
KK.0053526 (m)
KK.0053525 (ft)
 incl. single case



75 mm
 T2.1 | Ø 95 mm
 K2.0048100 (m)
 K2.0048098 (ft)
 only available in
 the Core Set



105 mm
 T2.1 | Ø 95 mm
 K2.0048102 (m)
 K2.0048101 (ft)
 only available in
 the Core Set



150 mm
 T2.5 | Ø 95 mm
KK.0053528 (m)
KK.0053527 (ft)
 incl. single case



250 mm
 T2.8 | Ø 114 mm
KK.0053531 (m)
KK.0053530 (ft)
 incl. Extender 1.4x
 and Extender 2.0x
 incl. single case



360 mm
 (250 mm + ARRI Ensō Extender 1.4X)
 T4.0 | Ø 114 mm



500 mm
 (250 mm + ARRI Ensō Extender 2.0X)
 T5.8 | Ø 114 mm

ARRI Ensō Primes - caps



**ARRI Ensō Prime
 Front Cap Ø 95 MM**
 K2.0049798



**ARRI Ensō Prime
 Front Cap Ø 114 MM**
 K2.0049799



**ARRI Ensō Prime
 Front Cap Ø 134 MM**
 K2.0049800



**ARRI Ensō Prime
 Front Cap Ø 156 MM**
 K2.0049801



**ARRI LPL Mount Ensō
 Rear Cap**
 K2.0049797

ARRI Ensō Extender

only compatible and available with Ensō Prime 250 mm



ARRI Ensō Extender 1.4X
 K2.0048107



ARRI Ensō Extender 2.0X
 K2.0048108



**ARRI LPL Mount Ensō
 Rear Cap**
 K2.0049797

ARRI Prime Lenses - spherical



Configuration Overview | 3.2.0 / 2025.09

ARRI Signature Primes

Format: Large Format
all Signature Primes will be delivered in a case



Magnetic Rear Filter Holder
[K2.0019522](#)

12 mm T1.8 Ø 134 mm	15 mm T1.8 Ø 156 mm	18 mm T1.8 Ø 114 mm	21 mm T1.8 Ø 114 mm	25 mm T1.8 Ø 114 mm	29 mm T1.8 Ø 114 mm	35 mm T1.8 Ø 114 mm	40 mm T1.8 Ø 114 mm	47 mm T1.8 Ø 114 mm	58 mm T1.8 Ø 114 mm	75 mm T1.8 Ø 114 mm	95 mm T1.8 Ø 114 mm	125 mm T1.8 Ø 114 mm	150 mm T1.8 Ø 114 mm	200 mm T2.5 Ø 114 mm	280 mm T2.8 Ø 134 mm
KK.0019185 (m) KK.0019183 (ft)	KK.0019188 (m) KK.0019187 (ft)	KK.0019191 (m) KK.0019189 (ft)	KK.0019193 (m) KK.0019192 (ft)	KK.0019196 (m) KK.0019194 (ft)	KK.0019199 (m) KK.0019197 (ft)	KK.0019102 (m) KK.0019099 (ft)	KK.0019201 (m) KK.0019200 (ft)	KK.0019105 (m) KK.0019104 (ft)	KK.0019203 (m) KK.0019202 (ft)	KK.0019107 (m) KK.0019106 (ft)	KK.0019205 (m) KK.0019204 (ft)	KK.0019109 (m) KK.0019108 (ft)	KK.0019207 (m) KK.0019206 (ft)	KK.0019210 (m) KK.0019209 (ft)	KK.0019213 (m) KK.0019211 (ft)

ARRI/ZEISS Master Prime Lenses

Format: SUPER 35

12 mm T1.3 Ø 156 mm	14 mm T1.3 Ø 114 mm	16 mm T1.3 Ø 114 mm	18 mm T1.3 Ø 114 mm	21 mm T1.3 Ø 114 mm	25 mm T1.3 Ø 114 mm	27 mm T1.3 Ø 114 mm	32 mm T1.3 Ø 114 mm	35 mm T1.3 Ø 114 mm	40 mm T1.3 Ø 114 mm	50 mm T1.3 Ø 114 mm	65 mm T1.3 Ø 114 mm	75 mm T1.3 Ø 114 mm	100 mm T1.3 Ø 114 mm	135 mm T1.3 Ø 114 mm	150 mm T1.3 Ø 134 mm
K2.47618.0 (m) K2.47718.0 (ft)	K2.47615.0 (m) K2.47715.0 (ft)	K2.47600.0 (m) K2.47700.0 (ft)	K2.47601.0 (m) K2.47701.0 (ft)	K2.47602.0 (m) K2.47702.0 (ft)	K2.47603.0 (m) K2.47703.0 (ft)	K2.47604.0 (m) K2.47704.0 (ft)	K2.47605.0 (m) K2.47705.0 (ft)	K2.47606.0 (m) K2.47706.0 (ft)	K2.47607.0 (m) K2.47707.0 (ft)	K2.47608.0 (m) K2.47708.0 (ft)	K2.47609.0 (m) K2.47709.0 (ft)	K2.47610.0 (m) K2.47710.0 (ft)	K2.47611.0 (m) K2.47711.0 (ft)	K2.47619.0 (m) K2.47719.0 (ft)	K2.47616.0 (m) K2.47716.0 (ft)

ARRI/ZEISS Ultra Prime Lenses *

Format: SUPER 35

8 mm R T2.8 Ø 134 mm	12 mm T2.0 Ø 156 mm	14 mm T1.9 Ø 114 mm	16 mm T1.9 Ø 95 mm	20 mm T1.9 Ø 95 mm	24 mm T1.9 Ø 95 mm	28 mm T1.9 Ø 95 mm	32 mm T1.9 Ø 95 mm	40 mm T1.9 Ø 95 mm	50 mm T1.9 Ø 95 mm	65 mm T1.9 Ø 95 mm	85 mm T1.9 Ø 95 mm	100 mm T1.9 Ø 95 mm	135 mm T1.9 Ø 95 mm	180 mm T1.9 Ø 114 mm
K2.47613.0 (m) K2.47612.0 (ft)	K2.47378.0 (m) K2.47380.0 (ft)	K2.47311.0 (m) K2.47323.0 (ft)	K2.47312.0 (m) K2.47324.0 (ft)	K2.47313.0 (m) K2.47325.0 (ft)	K2.47314.0 (m) K2.47326.0 (ft)	K2.47315.0 (m) K2.47327.0 (ft)	K2.47316.0 (m) K2.47328.0 (ft)	K2.47317.0 (m) K2.47329.0 (ft)	K2.47318.0 (m) K2.47330.0 (ft)	K2.47377.0 (m) K2.47379.0 (ft)	K2.47319.0 (m) K2.47331.0 (ft)	K2.47320.0 (m) K2.47332.0 (ft)	K2.47321.0 (m) K2.47333.0 (ft)	K2.47381.0 (m) K2.47382.0 (ft)

ARRI/ZEISS LDS Ultra Prime Lenses *

Format: SUPER 35

12 mm T2 Ø 156 mm	14 mm T1.9 Ø 114 mm	16 mm T1.9 Ø 104 mm	20 mm T1.9 Ø 104 mm	24 mm T1.9 Ø 104 mm	28 mm T1.9 Ø 104 mm	32 mm T1.9 Ø 104 mm	40 mm T1.9 Ø 104 mm	50 mm T1.9 Ø 104 mm	65 mm T1.9 Ø 104 mm	85 mm T1.9 Ø 104 mm	100 mm T1.9 Ø 104 mm	135 mm T1.9 Ø 104 mm	180 mm T1.9 Ø 114 mm
K2.52198.0 (m) K2.52199.0 (ft)	K2.52111.0 (m) K2.52123.0 (ft)	K2.52112.0 (m) K2.52124.0 (ft)	K2.52113.0 (m) K2.52125.0 (ft)	K2.52114.0 (m) K2.52126.0 (ft)	K2.52115.0 (m) K2.52127.0 (ft)	K2.52116.0 (m) K2.52128.0 (ft)	K2.52117.0 (m) K2.52129.0 (ft)	K2.52118.0 (m) K2.52130.0 (ft)	K2.52200.0 (m) K2.52201.0 (ft)	K2.52119.0 (m) K2.52131.0 (ft)	K2.52120.0 (m) K2.52132.0 (ft)	K2.52121.0 (m) K2.52133.0 (ft)	K2.52202.0 (m) K2.52203.0 (ft)

ARRI/ZEISS Ultra 16 Lenses *

Format: SUPER 16

6 mm T1.3 Ø 95 mm	8 mm T1.3 Ø 95 mm	9,5 mm T1.3 Ø 95 mm	12 mm T1.3 Ø 95 mm	14 mm T1.3 Ø 95 mm	18 mm T1.3 Ø 95 mm	25 mm T1.3 Ø 95 mm	35 mm T1.3 Ø 95 mm	50 mm T1.3 Ø 95 mm
K2.47560.0 (m) K2.47565.0 (ft)	K2.47561.0 (m) K2.47566.0 (ft)	K2.47562.0 (m) K2.47567.0 (ft)	K2.47563.0 (m) K2.47568.0 (ft)	K2.47564.0 (m) K2.47569.0 (ft)	K2.47580.0 (m) K2.47585.0 (ft)	K2.47581.0 (m) K2.47586.0 (ft)	K2.47582.0 (m) K2.47587.0 (ft)	K2.47583.0 (m) K2.47588.0 (ft)

ARRI/ZEISS Macro

Format: SUPER 35



100 mm, T2.0 | Ø 114 mm
[K2.47572.0](#) (m), [K2.47573.0](#) (ft)

SP Lens Caps

ARRI LPL Mount Lens Rear Cap Extended, [K2.0020097](#)
ARRI Signature Prime Front Cap Ø 156mm, [K2.0019316](#)
ARRI Signature Prime Front Cap Ø 134mm, [K2.0019314](#)
ARRI Signature Prime Front Cap Ø 114mm, [K2.0019308](#)

* discontinued items

ARRI/ZEISS Master Anamorphic Lenses

Format: SUPER 35

28 mm T1.9 Ø 114 mm K2.0010083 (m) K2.0010082 (ft)	35 mm T1.9 Ø 95 mm K2.47957.0 (m) K2.47942.0 (ft)	40 mm T1.9 Ø 95 mm K2.47958.0 (m) K2.47943.0 (ft)	50 mm T1.9 Ø 95 mm K2.47959.0 (m) K2.47944.0 (ft)	60 mm T1.9 Ø 95 mm K2.47960.0 (m) K2.47945.0 (ft)	75 mm T1.9 Ø 95 mm K2.47961.0 (m) K2.47946.0 (ft)	100 mm T1.9 Ø 95 mm K2.47962.0 (m) K2.47947.0 (ft)	135 mm T1.9 Ø 95 mm K2.47963.0 (m) K2.47948.0 (ft)	180 mm T2.8 Ø 95 mm K2.0010085 (m) K2.0010084 (ft)

ARRI/ZEISS Master Anamorphic Flare Sets

no picture available yet	no picture available yet	no picture available yet		no picture available yet	no picture available yet	no picture available yet	no picture available yet	no picture available yet	no picture available yet	no picture available yet
28 mm T1.9 Ø 95 mm K2.0012679	35 mm T1.9 Ø 95 mm K2.0006796	40 mm T1.9 Ø 95 mm K2.0006798	50 mm T1.9 Ø 95 mm K2.0006799	60 mm T1.9 Ø 95 mm K2.0006800	75 mm T1.9 Ø 95 mm K2.0006801	100 mm T1.9 Ø 95 mm K2.0006802	135 mm T1.9 Ø 95 mm K2.0006803	180 mm T1.9 Ø 95 mm K2.0014729	MA Toolkit for Flare Set K2.0006794	

ARRI Ultra Wide Zoom Lens

Format: SUPER 35 extended



Ultra Wide Zoom 9.5-18 mm
T2.9 | Ø 134 mm & 156 mm
[K2.47620.0](#) (m), [K2.0001686](#) (ft)

ARRI Anamorphic Ultra Wide Zoom Lens



Ultra Wide Zoom 19-36 mm
T4.2 | Ø 114 mm
[K2.0006969](#) (m), [K2.0006968](#) (ft)

ARRI/FUJINON ALURA Studio Zoom Lenses*

Format: SUPER 35, spherical

* discontinued items



ALURA ZOOM 18-80 mm
T2.6 | Ø 134 mm
[K2.47930.0](#) (m),
[K2.47931.0](#) (ft)

ALURA ZOOM 45-250 mm
T2.6 | Ø 134 mm
[K2.47932.0](#) (m),
[K2.47933.0](#) (ft)

ARRI/FUJINON ALURA LWZ Zoom Lenses*

Format: SUPER 35m, spherical

* discontinued items



ALURA LWZ ZOOM 15.5-45 mm
T2.8 | Ø 114 mm
[K2.47934.0](#) (m), [K2.47935.0](#) (ft)

ALURA LWZ ZOOM 30-80 mm
T2.8 | Ø 114 mm
[K2.47936.0](#) (m), [K2.47937.0](#) (ft)

ARRI/FUJINON LDS Extender *

* discontinued items



ALURA LDS Extender 1.4x (ALE1.4x)
[K2.47926.0](#)
ALURA LDS Extender 2.0x (ALE2.0x)
[K2.47927.0](#)

Alura Zoom	+	Alura Extender	=	Resulting combination
Alura 15.5-45 / T2.8	+	Alura LDS Extender 1.4x	=	Alura 22-63 / T4.0
Alura 15.5-45 / T2.8	+	Alura LDS Extender 2.0x	=	Alura 31-90 / T5.6
Alura 30-80 / T2.8	+	Alura LDS Extender 1.4x	=	Alura 42-112 / T4.0
Alura 30-80 / T2.8	+	Alura LDS Extender 2.0x	=	Alura 60-160 / T5.6
Alura 18-80 / T2.6	+	Alura LDS Extender 1.4x	=	Alura 25-112 / T3.7
Alura 18-80 / T2.6	+	Alura LDS Extender 2.0x	=	Alura 25-112 / T5.2
Alura 45-250 / T2.6	+	Alura LDS Extender 1.4x	=	Alura 63-350 / T3.7
Alura 45-250 / T2.6	+	Alura LDS Extender 2.0x	=	Alura 90-500 / T5.2

Configuration Overview | 3.4.0 / 2025.09

ARRI Impression V Filter

for Signature Primes and Signature Zoom Lenses

ARRI Impression V Filter Kit

[KK.0048312](#), includes:
 1x ARRI Impression V Aluminum Case
 1x ARRI Impression V Filter 070P
 1x ARRI Impression V Filter 140P
 1x ARRI Impression V Filter 230P
 1x ARRI Impression V Filter 330P
 1x ARRI Impression V Filter 050N
 1x ARRI Impression V Filter 100N
 1x ARRI Impression V Filter 200N
 1x ARRI Impression V Filter 290N
 1x ARRI Impression V Shim Set
 1x ARRI Impression V Velcro® Set
 1x Torque Screwdriver



ARRI Impression V 050N Filter Pack, [K2.0048143](#)

Includes:
 3x ARRI Impression V Filter 050N
 1x ARRI Impression V Shim Set
 2x ARRI Impression V Velcro® Set

ARRI Impression V 100N Filter Pack, [K2.0048144](#)

Includes:
 3x ARRI Impression V Filter 100N
 1x ARRI Impression V Shim Set
 2x ARRI Impression V Velcro® Set

ARRI Impression V 200N Filter Pack, [K2.0048145](#)

Includes:
 3x ARRI Impression V Filter 200N
 1x ARRI Impression V Shim Set
 2x ARRI Impression V Velcro® Set

ARRI Impression V 290N Filter Pack, [K2.0048146](#)

Includes:
 3x ARRI Impression V Filter 290N
 1x ARRI Impression V Shim Set
 2x ARRI Impression V Velcro® Set



ARRI Impression V 070P Filter Pack, [K2.0048139](#)

includes:
 3x ARRI Impression V Filter 070P
 3x ARRI Impression V Velcro® Set

ARRI Impression V 140P Filter Pack, [K2.0048140](#)

includes:
 3x ARRI Impression V Filter 140P
 3x ARRI Impression V Velcro® Set

ARRI Impression V 230P Filter Pack, [K2.0048141](#)

includes:
 3x ARRI Impression V Filter 230P
 3x ARRI Impression V Velcro® Set

ARRI Impression V 330P Filter Pack, [K2.0048142](#)

includes:
 3x ARRI Impression V Filter 330P
 3x ARRI Impression V Velcro® Set

ARRI Impression V Shim Pack, [K2.0048147](#)

includes:
 6x ARRI Impression V Shim Set

ARRI Impression V Velcro® Pack, [K2.0048148](#)

includes:
 6x ARRI Impression V Velcro® Set

ALEXA LPL LF FSND Filters

manual in-camera filters:
have to be inserted/removed by hand in contrast to the internal motorized FSND filters for ALEXA Mini, ALEXA Mini LF & Amira

ALEXA LPL LF FSND Filter Set, Full

K2.0018790, includes:
 K4.0015593 1x ALEXA LPL LF IFM Optical Clear
 K4.0015594 1x ALEXA LPL LF FSND 0.3
 K4.0015595 1x ALEXA LPL LF FSND 0.6
 K4.0015596 1x ALEXA LPL LF FSND 0.9
 K4.0015597 1x ALEXA LPL LF FSND 1.2
 K4.0015598 1x ALEXA LPL LF FSND 1.5
 K4.0015599 1x ALEXA LPL LF FSND 1.8
 K4.0015600 1x ALEXA LPL LF FSND 2.1
 K4.0015601 1x ALEXA LPL LF FSND 2.4
 K2.72144.0 1x IFM/Extenders Depth Gauge DG-1
 K4.0007655 1x ALEXA LF FSND Filter Case
 K4.0007656 1x ALEXA FSND Filter Insertion Tool
 K2.0019021 1x ALEXA LPL LF IFM Shim



ARRI FSND Matte Box Filters

ARRI FSND Filter Basic Set 6.6"x6.6"

[KK.0019785](#), includes:
[K2.0013892](#) 1x ARRI FSND 0.3 Filter 6.6" x 6.6"
[K2.0013894](#) 1x ARRI FSND 0.6 Filter 6.6" x 6.6"
[K2.0013896](#) 1x ARRI FSND 0.9 Filter 6.6" x 6.6"
[K2.0016922](#) 1x Optical Cleaning Cloth 14.6" x 17.7"

ARRI FSND Filter Pro Set 6.6"x6.6"

[KK.0019797](#), includes:
[K2.0013892](#) 1x ARRI FSND 0.3 Filter 6.6" x 6.6"
[K2.0013894](#) 1x ARRI FSND 0.6 Filter 6.6" x 6.6"
[K2.0013896](#) 1x ARRI FSND 0.9 Filter 6.6" x 6.6"
[K2.0013998](#) 1x ARRI FSND 1.2 Filter 6.6" x 6.6"
[K2.0013900](#) 1x ARRI FSND 1.5 Filter 6.6" x 6.6"
[K2.0013902](#) 1x ARRI FSND 1.8 Filter 6.6" x 6.6"
[K2.0013905](#) 1x ARRI FSND 2.1 Filter 6.6" x 6.6"
 K2.0013906 1x ARRI FSND 2.4 Filter 6.6" x 6.6"
[K2.0016922](#) 1x Optical Cleaning Cloth 14.6" x 17.7"



ARRI FSND Filter Basic Set 4"x5.56"

[KK.0019784](#), includes:
[K2.0013887](#) 1x ARRI FSND 0.3 Filter 4" x 5.65"
[K2.0013901](#) 1x ARRI FSND 0.6 Filter 4" x 5.65"
[K2.0013895](#) 1x ARRI FSND 0.9 Filter 4" x 5.65"
[K2.0016922](#) 1x Optical Cleaning Cloth 14.6" x 17.7"

ARRI FSND Filter Pro Set 4"x5.65"

[KK.0019789](#), includes:
[K2.0013887](#) 1x ARRI FSND 0.3 Filter 4" x 5.65"
[K2.0013901](#) 1x ARRI FSND 0.6 Filter 4" x 5.65"
[K2.0013895](#) 1x ARRI FSND 0.9 Filter 4" x 5.65"
[K2.0013904](#) 1x ARRI FSND 1.2 Filter 4" x 5.65"
[K2.0013897](#) 1x ARRI FSND 1.5 Filter 4" x 5.65"
[K2.0013890](#) 1x ARRI FSND 1.8 Filter 4" x 5.65"
[K2.0013903](#) 1x ARRI FSND 2.1 Filter 4" x 5.65"
[K2.0013891](#) 1x ARRI FSND 2.4 Filter 4" x 5.65"
[K2.0016922](#) 1x Optical Cleaning Cloth 14.6" x 17.7"

ARRI ALEXA PL S35 FSND Filters



ARRI Ensō Vintage Elements Kit

[KK.0049815](#), includes:
 ARRI Ensō VE 100P / VE 200P / VE 350P / VE 100N / VE 200N / VE 350N
 ARRI Ensō Creative Adapter + Retaining Rings
 ARRI Ensō VE Shim Set
 Adjustable Torque Screwdriver
 ARRI Ensō Retaining Ring Tool
 (all in 1 case)
 currently only available in the Ensō Core Sets [K0.0052482](#) and [K0.0052483](#)

ARRI ALEXA PL S35 FSND Filters

manual in-camera filters:
have to be inserted/removed by hand in contrast to the internal motorized FSND filters for ALEXA Mini, ALEXA Mini LF & Amira

The content of the Basic set combined with the content of the Completion set equals the content of the Full set.



ALEXA PL S35 FSND Filter Set, Full

K2.72139.0, includes:
 K4.73069.0 1x ALEXA PL S35 FSND 0.3
 K4.73070.0 1x ALEXA PL S35 FSND 0.6
 K4.73071.0 1x ALEXA PL S35 FSND 0.9
 K4.73072.0 1x ALEXA PL S35 FSND 1.2
 K4.73073.0 1x ALEXA PL S35 FSND 1.5
 K4.73074.0 1x ALEXA PL S35 FSND 1.8
 K4.73075.0 1x ALEXA PL S35 FSND 2.1
 K4.73076.0 1x ALEXA PL S35 FSND 2.4
 K4.73062.0 1x ALEXA PL S35 IFM Optical Clear
 K2.72143.0 1x ALEXA PL S35 IFM Shim
 K4.52722.0 1x Ground Glass/Frameglow tool
 K2.72144.0 1x IFM/Extenders Depth Gauge DG-1
 K4.73081.0 1x Case

ALEXA PL S35 FSND Filter Set, Completion

K2.72138.0, includes:
 K4.73069.0 1x ALEXA PL S35 FSND 0.3
 K4.73071.0 1x ALEXA PL S35 FSND 0.9
 K4.73073.0 1x ALEXA PL S35 FSND 1.5
 K4.73075.0 1x ALEXA PL S35 FSND 2.1
 K4.73076.0 1x ALEXA PL S35 FSND 2.4

ALEXA PL S35 FSND Filter Set, Basic

K2.72137.0, includes:
 K4.73070.0 1x ALEXA PL S35 FSND 0.6
 K4.73072.0 1x ALEXA PL S35 FSND 1.2
 K4.73074.0 1x ALEXA PL S35 FSND 1.8
 K4.73062.0 1x ALEXA PL S35 IFM Optical Clear
 K2.72143.0 1x ALEXA PL S35 IFM Shim
 K4.52722.0 1x Ground Glass/Frameglow tool
 K2.72144.0 1x IFM/Extenders Depth Gauge DG-1
 K4.73081.0 1x Case

Cinefade Vari360



cmotion Cinefade Vari360

[KK.0053991](#)
 includes:
 1x Static Polariser
 1x Motorized Polariser
 1x 3/8" mounting point for safety loop
 1x cmotion Cinefade Vari360 hard case

for add. recommended products please see price list:

Hi-5 Hand Unit:
Cinefade License Key for Hi-5, [10.0040586](#)

Cable LBUS (angled) - LBUS (straight) (0.35m/1.15ft), [K2.0013042](#)
Cable LBUS - D-Tap (0.8m/2.6ft) [K2.0006758](#)

Rota Pola



Rota Pola Filter Frame 4x5.65
[K2.0009434](#)



Rota Pola Filter Frame 6.6x6.6
[K2.0017086](#)

Electronic Control System - Overview



Configuration Overview | 4.0.0 / 2025.10

Hi-5 & RIA incl. Accessories

For more details please see specific Configuration Overviews for Hi-5 and RIA-1



Hi-5 Hand Unit Body Kit, [KK.0039973](#)

Includes:
[K2.0037280](#) 1x Hi-5 Hand Unit Body Naked
[K2.0039838](#) 1x Bluetooth Dongle
[K2.0037463](#) 1x Smart Focus Ring Blank

Hi-5 Hand Unit Basic Set w/o Batteries, Charger, [KK.0042529](#)

Includes:
[KK.0039973](#) 1x Hi-5 Hand Unit Body Kit
[K2.0033702](#) 1x RF-EMIP Radio Module 2400 MHz DSSS
[K2.0039959](#) 1x Hi-5 Neck Strap
[K2.0039958](#) 1x Hi-5 Hand Strap
[K2.0040015](#) 1x Hi-5 PanzerGlass

Please note: Batteries and battery charger are not included!



RF-EMIP Radio Module 2400 MHz DSSS Set (2x), [KK.0039985](#) (white)
 includes:
[K2.0033702](#), RF-EMIP Radio Module 2400 MHz DSSS (2x)



Radio Interface Adapter RIA-1 Set, [KK.0039980](#)
 includes:
[K2.0036186](#) 1x Radio Interface Adapter RIA-1
[K2.0039465](#) 1x RIA-1 Bracket

Zoom Control

For more details please see specific Configuration Overviews for ZMU-4



ZMU-4 Basic Set, [KK.0043770](#)

includes:
[K2.0039926](#) 1x ZMU-4 Zoom Main Unit Body
[K2.0033702](#) 1x RF-EMIP Radio Module 2400 MHz DSSS
[K2.0041744](#) 1x Rosette Adapter RA-7
[K2.0044203](#) 1x Rosette Adapter RA-8
[K2.0044543](#) 1x ZMU-4 ARRI Rosette



ZMU-4 Body
[K2.0039926](#)



cmotion steady zoom
[K2.0042582](#)
 LBUS Cables not included



cmotion pan-bar zoom
[K2.0042582](#)
 LBUS Cables not included

Hi-5 SX Single Axis Sets



Hi-5 SX Body Kit, [KK.0051704](#)

Includes:
[K2.0037280](#) 1x Hi-5 Hand Unit Body Naked
[K2.0039838](#) 1x Bluetooth Dongle
[K2.0037463](#) 1x Custom Smart Ring
[K4.0042707](#) 1x Hi-5 Force-Pad Cover Black

Hi-5 SX Basic Set w/o Batteries, Charger, [KK.0051705](#)

Includes:
[KK.0051704](#) 1x Hi-5 SX Body Kit
[K2.0040015](#) 1x Hi-5 PanzerGlass
[K2.0039958](#) 1x Hi-5 Hand Strap
[K2.0039959](#) 1x Hi-5 Neck Strap
[K2.0033702](#) 1x RF-EMIP Radio Module 2400 MHz DSSS

Hi-5 SX Basic Set, [KK.0051708](#)

Includes:
[KK.0051705](#) 1x Hi-5 SX Basic Set w/o Batteries, Charger
[K2.0036022](#) 2x Li-Ion Battery Pack LBP-3500
[K2.0039874](#) 1x LBP Battery Charger

ECS Single Axis Starter Set, [KK.0051713](#)

Includes:
[KK.0051705](#) 1x Hi-5 SX Basic Set w/o Batteries, Charger
[K2.0036022](#) 2x Li-Ion Battery Pack LBP-3500
[K2.0039874](#) 1x LBP Battery Charger
[KK.0040345](#) 1x cforce mini RF Basic Set 2
[K2.0006758](#) 1x Cable LBUS - D-Tap (0.8m/2.6ft)
[K2.0015760](#) 1x Cable CAM (7p) - LBUS (0.5m/1.6ft)
[K2.0015754](#) 1x Cable CAM (7p) - RS (0.3m/1ft)

Motor Controller



Universal Motor Controller UMC-4 LDS, [K2.0002058](#)
 incl. L-Bracket [K2.0001967](#)



Radio Interface Adapter RIA-1
[K2.0036186](#)
 here shown combined with RF-EMIP 2400 MHz DSSS Radio Module, [K2.0033702](#)

Operator Control Unit



Operator Control Unit OCU-1 Extended Set 2

[KK.0040346](#)
 includes:
[K2.0020002](#) 1x Operator Control Unit OCU-1 Basic Set
[K2.0020003](#) 1x OCU-1 Rosette Bracket
[K2.0036610](#) 1x cforce mini Clamp Console 2 19/15mm



Operator Control Unit OCU-1 Basic Set,
[K2.0020002](#)



OCU-1 Rosette Bracket
[K2.0020003](#)



OCU-1 Dovetail Mounting Interface
[K2.0022269](#)



CLM-5/cforce mini Clamp Console 19/15mm,
[K2.0006176](#)
 kompatibel with OCU



cforce mini Clamp Console 2 19/15mm,
[K2.0036610](#)

Master Grips



Master Grip Left Wheel MLW-1
[K2.0009363](#)



Master Grip Right Rocker MRR-1
[K2.0009493](#)

further Configurations regarding Master Grips available, starting with Config 4.9.0

LCUBE converters



LCUBE - CUB-1 (Basic Set)
[KK.0009001](#)



LCUBE CUB-1
[K2.0008630](#)



LCUBE Bracket
[K2.0009620](#)



LCUBE - CUB-2 (Basic Set)
[KK.0013217](#)



LCUBE CUB-2
[K2.0010681](#)



LCUBE Bracket
[K2.0009620](#)



Cable LENS/ENG (12p) - Hi (12p) analog,
[K2.0022328](#)

LBUS 0.2m/8", [K2.0006749](#)
 LBUS 0.3m/1ft, [K2.0006750](#)
 LBUS 0.5m/1.5ft, [K2.0006751](#)
 LBUS 0.8m/2.5ft, [K2.0006752](#)
 LBUS 1.5m/5ft, [K2.0006753](#)
 LBUS 3m/10ft, [K2.0006754](#)
 LBUS 6m/20ft, [K2.0006755](#)
 LBUS 15m/49ft, [K2.0006756](#)

Cable LBUS - D-Tap (1.2m/4ft)
[K2.0006757](#)

Cable LBUS - RS (0.8m/2.6ft)
[K2.0006759](#)

Cable LBUS - XLR (4p) (0.8m/2.6ft),
[K2.0006760](#)

Hi-5 / Hi-5 SX / RIA / Radio Modules - Overview



Configuration Overview | 4.1.0 / 2025.10

Hi-5 Hand Unit Sets

Hi-5 Hand Unit Body Kit, [KK.0039973](#)

Includes:
[K2.0037280](#) 1x Hi-5 Hand Unit Body Naked
[K2.0039838](#) 1x Bluetooth Dongle
[K2.0037463](#) 1x Smart Focus Ring Blank

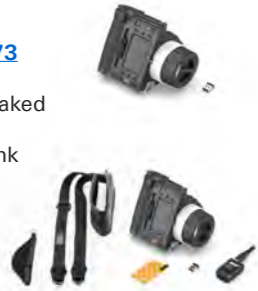

Hi-5 Hand Unit Basic Set w/o Batteries, Charger, [KK.0042529](#)

Includes:
[K2.0039973](#) 1x Hi-5 Hand Unit Body Kit
[K2.0033702](#) 1x RF-EMIP Radio Module 2400 MHz DSSS
[K2.0039959](#) 1x Hi-5 Neck Strap
[K2.0039958](#) 1x Hi-5 Hand Strap
[K2.0040015](#) 1x Hi-5 PanzerGlass



Please note: Batteries and battery charger are not included!



Hi-5 Hand Unit Basic Set, [KK.0041791](#)

includes:
[KK.0042529](#) 1x Hi-5 Hand Unit Basic Set w/o Batteries, Charger
[K2.0039874](#) 1x LBP Battery Charger
[K2.0036022](#) 2x Li-Ion Battery Pack LBP-3500



Hi-5 RX-TX 2400 Set, [KK.0041793](#)

Includes:
[KK.0042529](#) 1x Hi-5 Hand Unit Basic Set w/o Batteries, Charger
[K2.0039874](#) 1x LBP Battery Charger
[K2.0036022](#) 3x Li-Ion Battery Pack LBP-3500
[K2.0037880](#) 1x Hi-5 Monitor Bracket
[KK.0039980](#) 1x Radio Interface Adapter RIA-1 Set
[KK.0039984](#) 1x RF-2400 Radio Module 2400 MHz FHSS Set (2x)



Hi-5 RX-TX 900 Set, [KK.0041792](#)

includes:
[KK.0042529](#) 1x Hi-5 Hand Unit Basic Set w/o Batteries, Charger
[K2.0039874](#) 1x LBP Battery Charger
[K2.0036022](#) 3x Li-Ion Battery Pack LBP-3500
[K2.0037880](#) 1x Hi-5 Monitor Bracket
[KK.0039980](#) 1x Radio Interface Adapter RIA-1 Set
[KK.0039986](#) 1x RF-900 Radio Module 900 MHz FHSS Set (2x)



Hi-5 SX Single Axis Hand Unit Sets

Hi-5 SX Body Kit, [KK.0051704](#)

Includes:
[K2.0037280](#) 1x Hi-5 Hand Unit Body Naked
[K2.0039838](#) 1x Bluetooth Dongle
[K2.0037463](#) 1x Custom Smart Ring
[K4.0042707](#) 1x Hi-5 Force-Pad Cover Black



Hi-5 SX Basic Set w/o Batteries, Charger, [KK.0051705](#)

Includes:
[KK.0051704](#) 1x Hi-5 SX Body Kit
[K2.0040015](#) 1x Hi-5 PanzerGlass
[K2.0039958](#) 1x Hi-5 Hand Strap
[K2.0039959](#) 1x Hi-5 Neck Strap
[K2.0033702](#) 1x RF-EMIP Radio Module 2400 MHz DSSS



Hi-5 SX Basic Set, [KK.0051708](#)

Includes:
[KK.0051705](#) 1x Hi-5 SX Basic Set w/o Batteries, Charger
[K2.0036022](#) 2x Li-Ion Battery Pack LBP-3500
[K2.0039874](#) 1x LBP Battery Charger



ECS Single Axis Starter Set, [KK.0051713](#)

Includes:
[KK.0051705](#) 1x Hi-5 SX Basic Set w/o Batteries, Charger
[K2.0036022](#) 2x Li-Ion Battery Pack LBP-3500
[K2.0039874](#) 1x LBP Battery Charger
[KK.0040345](#) 1x cforce mini RF Basic Set 2
[K2.0006758](#) 1x Cable LBUS - D-Tap (0.8m/2.6ft)
[K2.0015760](#) 1x Cable CAM (7p) - LBUS (0.5m/1.6ft)
[K2.0015754](#) 1x Cable CAM (7p) - RS (0.3m/1ft)



Single Parts

 Hi-5 Hand Unit Body Naked, [K2.0037280](#)



 Hi-5 Monitor Bracket [K2.0037880](#)



 Hi-5 PanzerGlass [K2.0040015](#)

 Li-Ion Battery Pack LBP-3500, [K2.0036022](#)

 LBP Battery Charger [K2.0039874](#)

 RF-Cover [K2.0039965](#)

 Hi-5 Hand Strap [K2.0039958](#)

 Hi-5 Neck Strap [K2.0039959](#)

 Bluetooth Dongle [K2.0039838](#)

RIA & Radio Modules

Radio Interface Adapter RIA-1 Set, [KK.0039980](#)

includes:
[K2.0036186](#) 1x Radio Interface Adapter RIA-1
[K2.0039465](#) 1x RIA-1 Bracket



RF-EMIP Radio Module 2400 MHz DSSS Set (2x), [KK.0039985](#) (white)
 includes:
[K2.0033702](#), RF-EMIP Radio Module 2400 MHz DSSS (2x)



RF-2400 Radio Module 2400 MHz FHSS Set (2x), [KK.0039984](#) (orange)
 includes:
[K2.0036598](#), RF-2400 Radio Module 2400 MHz FHSS (2x)



RF-900 Radio Module 900 MHz FHSS Set (2x), [KK.0039986](#) (grey)
 includes:
[K2.0036599](#), RF-900 Radio Module 900 MHz FHSS (2x)
 (not available yet)



License Key

 Cinefade VariND

Cinefade License Key for Hi-5, [10.0040586](#)

 Focusbug License Key

Focusbug License Key for Hi-5, [10.0040585](#)

 Sony Camera Control License Key for Hi-5, [10.0040584](#)

RED Camera Control License Key for Hi-5, [10.0040582](#)

 RED Camera Control License Key for Hi-5, [10.0040582](#)

Hi-5 SX Plus License [10.0051711](#)

 Hi-5 SX Plus License

Hi-5 SX All-Axis License [10.0051712](#)

 Hi-5 SX All-Axis License

 Radio Interface Adapter RIA-1 [K2.0036186](#)

Radio Interface Adapter RIA-1
[K2.0036186](#)

 RF-900 Radio Module 900 MHz FHSS, [K2.0036599](#) (grey)
 (not available yet)

RF-2400 Radio Module 2400 MHz FHSS,
[K2.0036598](#) (orange)



 RF-EMIP Radio Module 2400 MHz DSSS, [K2.0033702](#) (white)

RIA-1 Bracket
[K2.0039465](#)

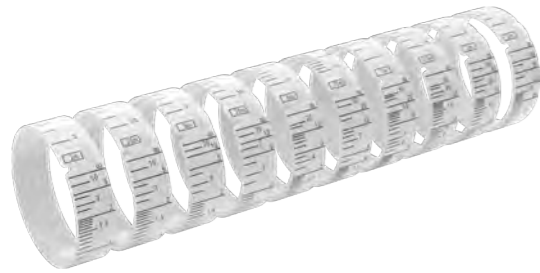

Rings for Hi-5 & Hi-5 SX

Standard Rings



Smart Focus Ring Set Meter, [KK.0047821](#)

includes:

- Smart Focus Ring 0.20m, [K2.0040110](#)
- Smart Focus Ring 0.25m, [K2.0040111](#)
- Smart Focus Ring 0.30m, [K2.0040112](#)
- Smart Focus Ring 0.35m, [K2.0040113](#)
- Smart Focus Ring 0.50m, [K2.0040114](#)
- Smart Focus Ring 0.75m, [K2.0040115](#)
- Smart Focus Ring 1.00m, [K2.0040116](#)
- Smart Focus Ring 1.50m, [K2.0040117](#)
- Smart Focus Ring 2.00m, [K2.0040118](#)
- Smart Focus Ring 3.00m, [K2.0040119](#)

Smart Focus Ring Set Feet, [KK.0047820](#)

includes:

- Smart Focus Ring 1', [K2.0040121](#)
- Smart Focus Ring 1'3, [K2.0040122](#)
- Smart Focus Ring 1'8, [K2.0040123](#)
- Smart Focus Ring 2', [K2.0040280](#)
- Smart Focus Ring 2'6, [K2.0040124](#)
- Smart Focus Ring 3'6, [K2.0040125](#)
- Smart Focus Ring 5', [K2.0040126](#)
- Smart Focus Ring 6'6, [K2.0040127](#)
- Smart Focus Ring 9", [K2.0040120](#)
- Smart Focus Ring 10', [K2.0040128](#)

Hi-5 Custom Smart Ring Set (5x) [KK.0051709](#)

includes:

- 5x Custom Smart Ring, [K2.0037463](#)

Smart Focus Ring Blank, [K2.0037463](#)

Left Hander Rings



Smart Focus Ring Left Hander Set Meter (10x), [KK.0047205](#),

includes:

- Smart Focus Ring Left Hander 0.20m, [K2.0047241](#)
- Smart Focus Ring Left Hander 0.25m, [K2.0047242](#)
- Smart Focus Ring Left Hander 0.30m, [K2.0047243](#)
- Smart Focus Ring Left Hander 0.35m, [K2.0047244](#)
- Smart Focus Ring Left Hander 0.50m, [K2.0047245](#)
- Smart Focus Ring Left Hander 0.75m, [K2.0047246](#)
- Smart Focus Ring Left Hander 1.00m, [K2.0047247](#)
- Smart Focus Ring Left Hander 1.50m, [K2.0047248](#)
- Smart Focus Ring Left Hander 2.00m, [K2.0047249](#)
- Smart Focus Ring Left Hander 3.00m, [K2.0047250](#)

Smart Focus Ring Left Hander Set Feet (10x), [KK.0047206](#),

includes:

- Smart Focus Ring Left Hander 9", [K2.0047251](#)
- Smart Focus Ring Left Hander 1', [K2.0047252](#)
- Smart Focus Ring Left Hander 1'3, [K2.0047253](#)
- Smart Focus Ring Left Hander 1'8, [K2.0047254](#)
- Smart Focus Ring Left Hander 2', [K2.0047255](#)
- Smart Focus Ring Left Hander 2'6, [K2.0047256](#)
- Smart Focus Ring Left Hander 3'6, [K2.0047257](#)
- Smart Focus Ring Left Hander 5', [K2.0047258](#)
- Smart Focus Ring Left Hander 6'6, [K2.0047259](#)
- Smart Focus Ring Left Hander 10', [K2.0047260](#)

Reversed Rings



Smart Focus Ring Reverse Set Meter (10x), [KK.0047203](#)

includes:

- Smart Focus Ring Reverse 0.20m, [K2.0047220](#)
- Smart Focus Ring Reverse 0.25m, [K2.0047221](#)
- Smart Focus Ring Reverse 0.30m, [K2.0047222](#)
- Smart Focus Ring Reverse 0.35m, [K2.0047223](#)
- Smart Focus Ring Reverse 0.50m, [K2.0047224](#)
- Smart Focus Ring Reverse 0.75m, [K2.0047225](#)
- Smart Focus Ring Reverse 1.00m, [K2.0047226](#)
- Smart Focus Ring Reverse 1.50m, [K2.0047227](#)
- Smart Focus Ring Reverse 2.00m, [K2.0047228](#)
- Smart Focus Ring Reverse 3.00m, [K2.0047229](#)

Smart Focus Ring Reverse Set Feet (10x), [KK.0047204](#)

includes:

- Smart Focus Ring Reverse 9", [K2.0047230](#)
- Smart Focus Ring Reverse 1', [K2.0047231](#)
- Smart Focus Ring Reverse 1'3, [K2.0047232](#)
- Smart Focus Ring Reverse 1'8, [K2.0047233](#)
- Smart Focus Ring Reverse 2', [K2.0047234](#)
- Smart Focus Ring Reverse 2'6, [K2.0047235](#)
- Smart Focus Ring Reverse 3'6, [K2.0047236](#)
- Smart Focus Ring Reverse 5', [K2.0047237](#)
- Smart Focus Ring Reverse 6'6, [K2.0047238](#)
- Smart Focus Ring Reverse 10', [K2.0047239](#)

Iris Rings



Smart Iris Ring Set (5x), [KK.0047207](#)

includes:

- Smart Iris Ring T1.0-T22, [K2.0047208](#)
- Smart Iris Ring T1.4-T22, [K2.0047209](#)
- Smart Iris Ring T2.0-T22, [K2.0047211](#)
- Smart Iris Ring T2.8-T22, [K2.0047212](#)
- Smart Iris Ring T1.0-Close, [K2.0047213](#)

RIA-1 - Cable Guide



Configuration Overview | 4.1.3 / 2025.10

Item Number	Cable Name	Supported Cameras	Camera Control		
			Run/Stop?	on Hi-5	on WCU-4
K2.0025027	Cable CAM (7p) – LBUS (0.3m/1ft)	ALEXA 35	Yes	Yes	Yes
K2.0015760	Cable CAM (7p) – LBUS (0.5m/1.6ft)	ALEXA 35	Yes	Yes	Yes
K2.0015756	Cable CAM (7p) – EXT (6p) (0.6m/2ft)	ALEXA Mini, ALEXA Mini LF, AMIRA	Yes	Yes	Yes
K2.0015755	Cable CAM (7p) – EXT (16p) (0.8m/2.6ft)	ALEXA Classic EV, ALEXA XT EV, ALEXA SXT EV. Only works with ALEXA EV cameras, not ALEXA Plus	Yes	Yes	Yes
K2.0034580	Cable CAM (7p) - LCS (5p) (0.8m/2.6ft)	ALEXA Plus cameras including ALEXA Plus, ALEXA XT Plus, ALEXA SXT Plus, ALEXA LF, ALEXA 65	Yes	Yes	Yes
K2.0015758	Cable CAM (7p) – RED CTRL/D-Tap (0.6m/2ft)	RED DSMC2 cameras except those with Base Expander Module. RED DSMC3 cameras (Komodo/V-Raptor) with module or break-out cable from 9p Lemo EXT Connector to RED CTRL connector. Supports run/stop/tally on WCU-4 and Hi-5. Additional RED Camera Control License Key required for further camera control on Hi-5	Yes	Yes	No
K2.0015757	Cable CAM (7p) – LANC/D-Tap (0.6m/2ft)	Many cameras with a LANC connector including Canon C300/C500 series, Sony PXW-FX9/FS7 and Blackmagic Ursa Mini Pro	Yes	No	No
K2.0018814	Cable CAM (7p) – Sony Venice/F55 CTRL/D-Tap (0.6m/2ft)	Sony F5/F55 and Sony Venice. Not compatible with Sony Venice 2, Panasonic Varicam, Panasonic Varicam LT	Yes	No	No
K2.0047268	Cable CAM (7p) - Sony Remote (8p)/D-Tap (0.8m/2.6ft)	Run/stop/tally for Sony Venice and Venice 2. Additional camera control supported on Hi-5 with Sony Camera Control License Key for Hi-5	Yes	Yes	No
K2.0015754	Cable CAM (7p) – RS (0.3m/1ft)	Run/stop/tally on all ARRI Cameras and any camera that supports run/stop via a 3p Fischer connector. Can also be used power the RIA-1 without any camera connection	Yes	No	No
K2.0018813	Cable CAM (7p) – D-Tap (0.5m/1.6ft)	For powering the RIA-1 without any camera connection	No	No	No
K2.0023832	Cable CAM (7p, f) – CAM (7p, m) (0.3m/1ft)	Extension cable for any CAM cable	N/A	N/A	N/A
K2.0015759	Cable CAM (7p) – ENG (12p) (0.3m/1ft)i	Can be used to inject lens metadata into Sony Venice and Venice 2 LENS connector.	N/A	N/A	N/A
K2.0044396	Cable CineTape – SERIAL(4p) (0.8m/2.6ft)	Connects CineTape to 4p SERIAL connector on RIA-1 and ALEXA 35	N/A	N/A	N/A
K2.0041172	Cable UDM - SERIAL (4p) (0.8m/2.6ft)	Connects UDM-1 to SERIAL connector on RIA-1 and ALEXA 35	N/A	N/A	N/A
K2.0025324	Cable UDM – SERIAL (4p) (0.5m/1.5ft)	Connects UDM-1 to SERIAL connector on RIA-1 and ALEXA 35	N/A	N/A	N/A
N/A	Cine RT to ARRI RIA-1 / ALEXA 35	Connects Focusbug Cine RT to SERIAL connector on RIA-1 and ALEXA 35. Available only from Focusbug.	N/A	N/A	N/A

Note: Sony and RED Camera Control Licenses required for camera control on Hi-5. ALEXA Remote License Key required for ALEXA/AMIRA camera control on WCU-4.

Hi-5 and RIA-1 - Sample Configurations ALEXA 35



Configuration Overview | 4.1.4 / 2026.04

ALEXA 35 with OCU-1

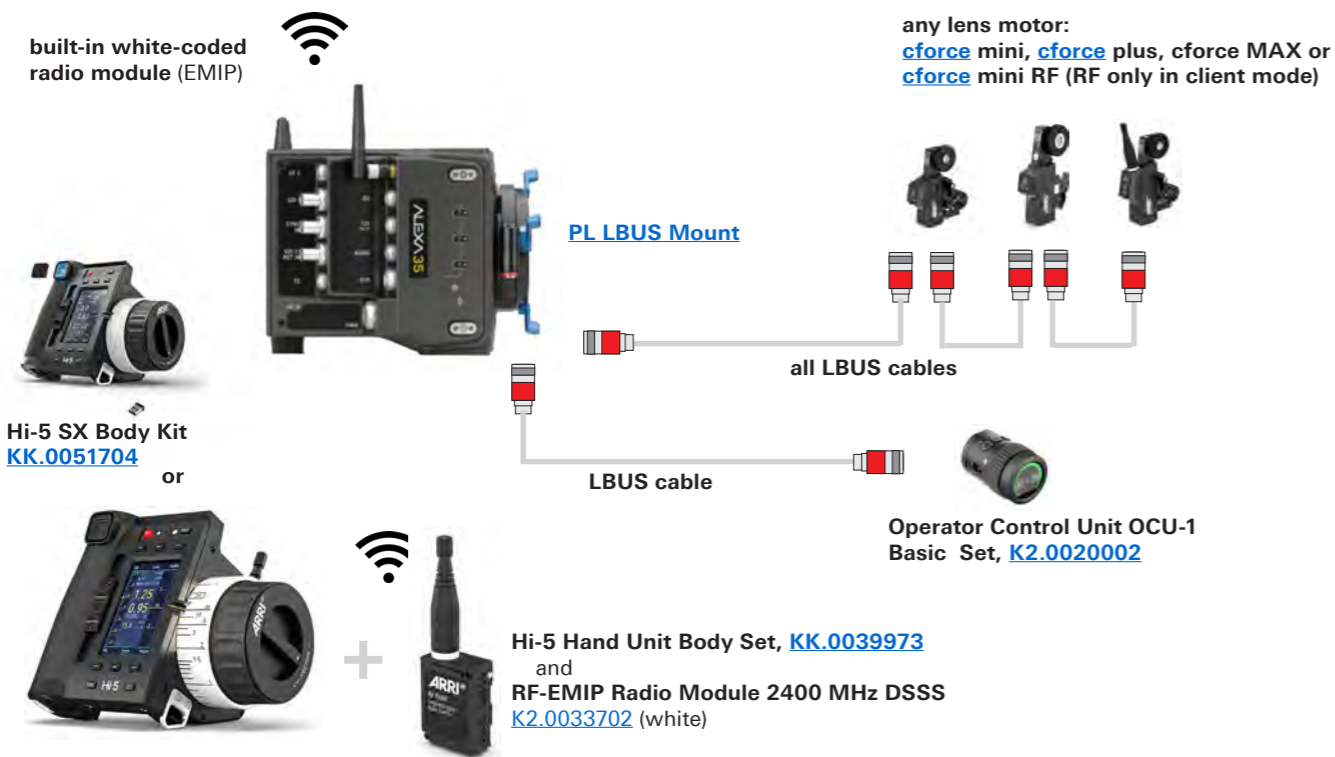

ALEXA 35 with RIA-1 & UDM-1

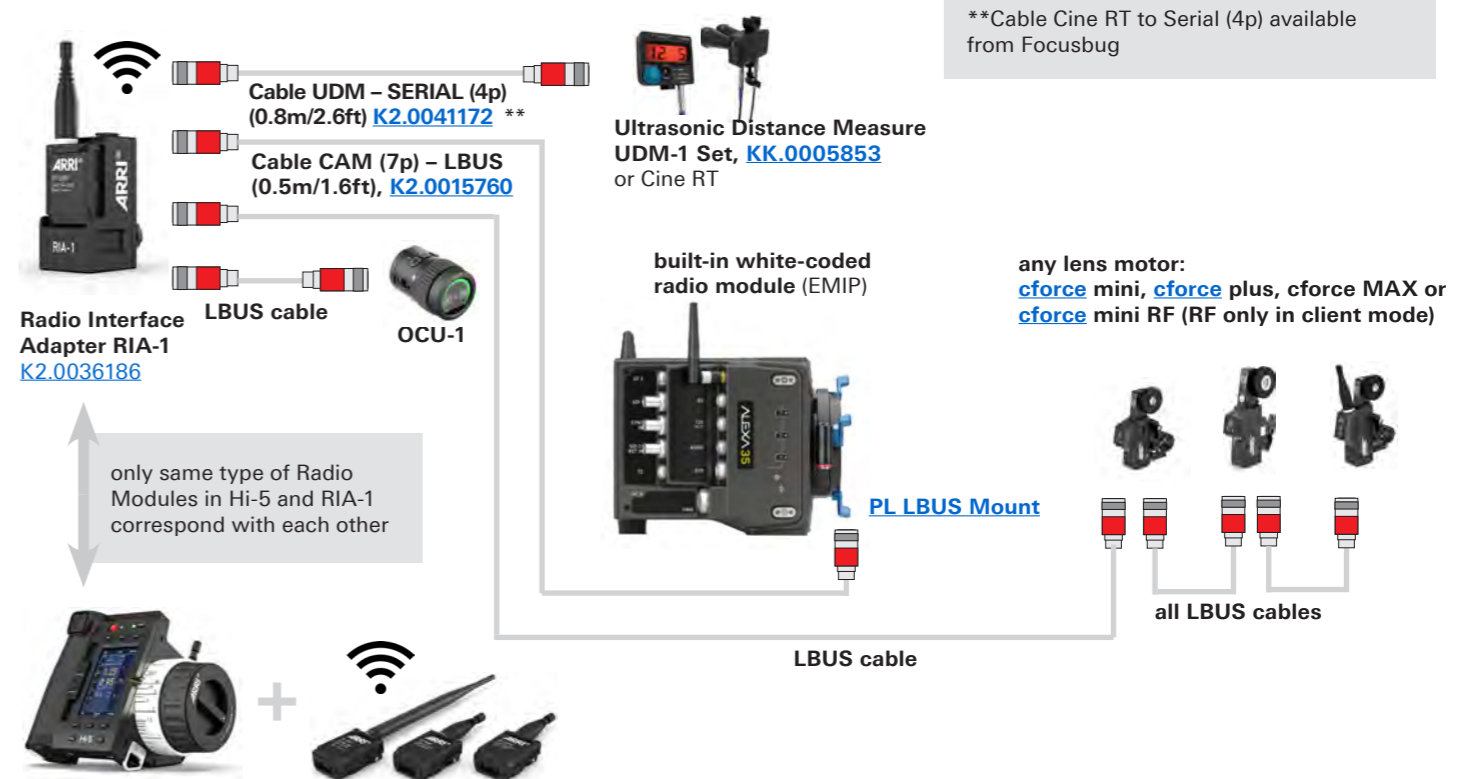

ALEXA 35 with RIA-1 as Host & Client

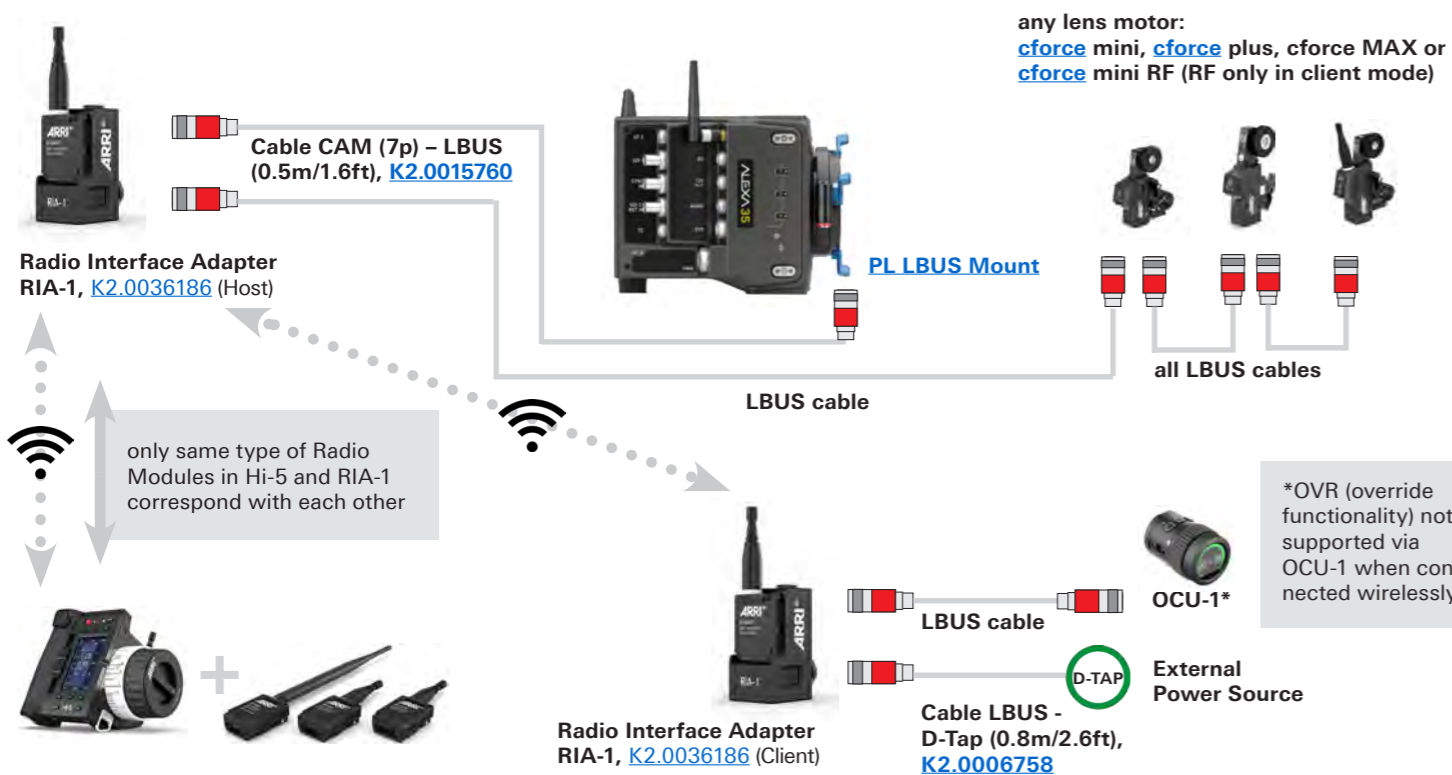

ALEXA 35 with RIA-1 as Host & Client

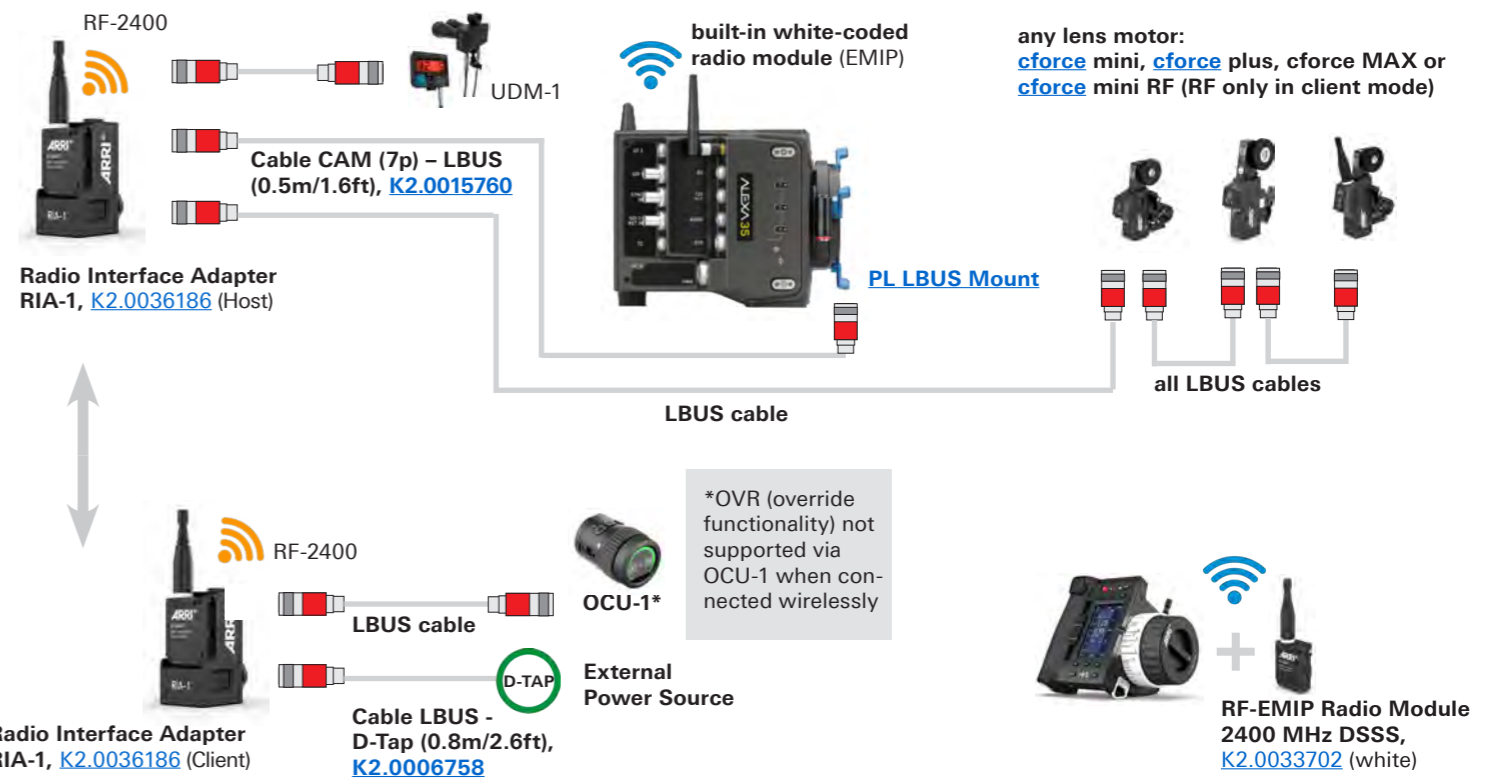

Hi-5 and RIA-1 - Sample Configurations ALEXA Mini LF



Configuration Overview | 4.1.5 / 2026.04

ALEXA Mini / ALEXA Mini LF with OCU-1



ALEXA Mini / ALEXA Mini LF



ALEXA Mini LF with RIA-1

this ALEXA Mini LF & RIA-1 Configuration requires SUP 7.3 or higher



ALEXA Mini LF with RIA-1 & UDM-1

this ALEXA Mini LF & RIA-1 Configuration requires SUP 7.3 or higher

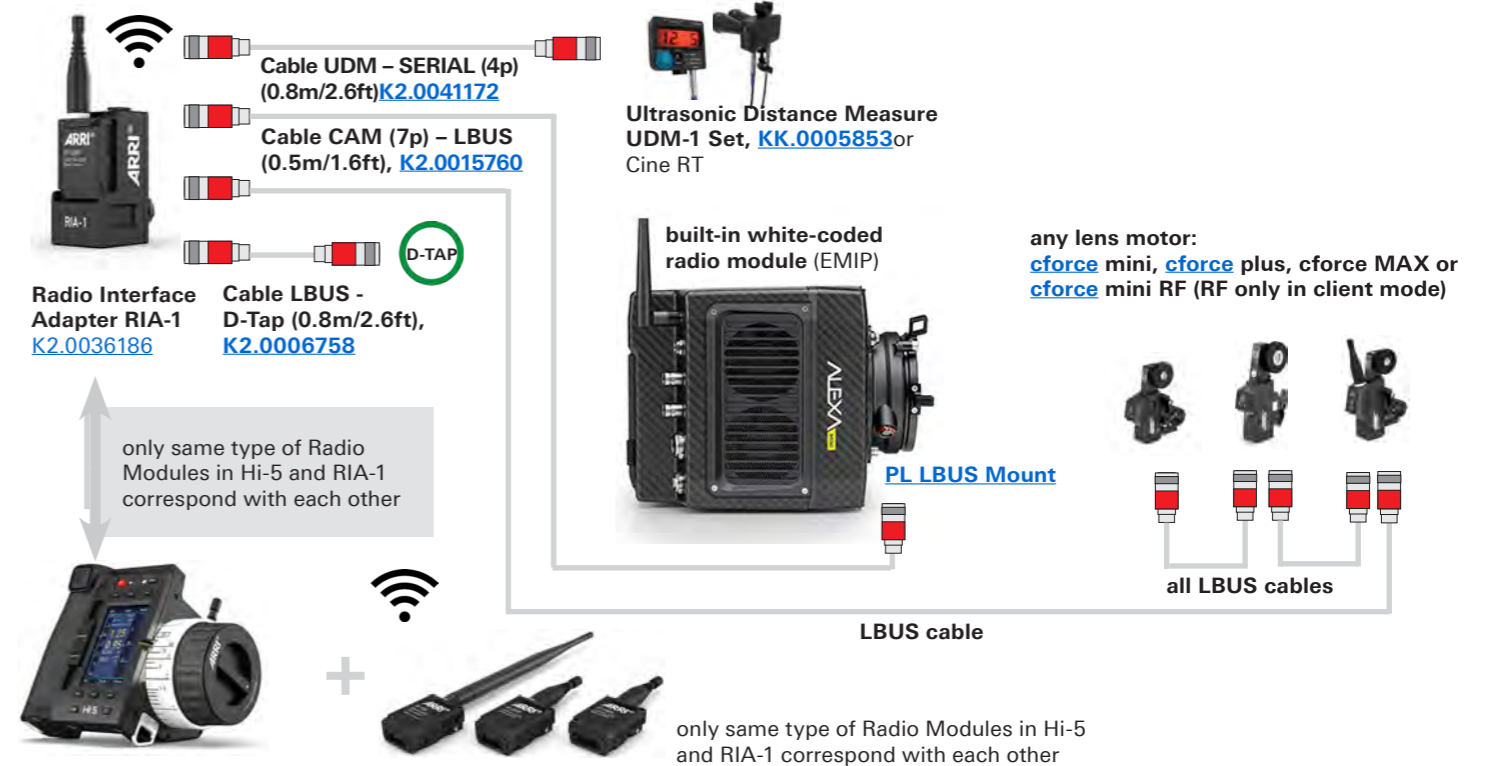

Hi-5 and RIA-1 - Sample Configurations ALEXA LF



Configuration Overview | 4.1.6 / 2026.04

ALEXA LF / ALEXA 65 & RIA-1 & UDM-1 & cforce motors

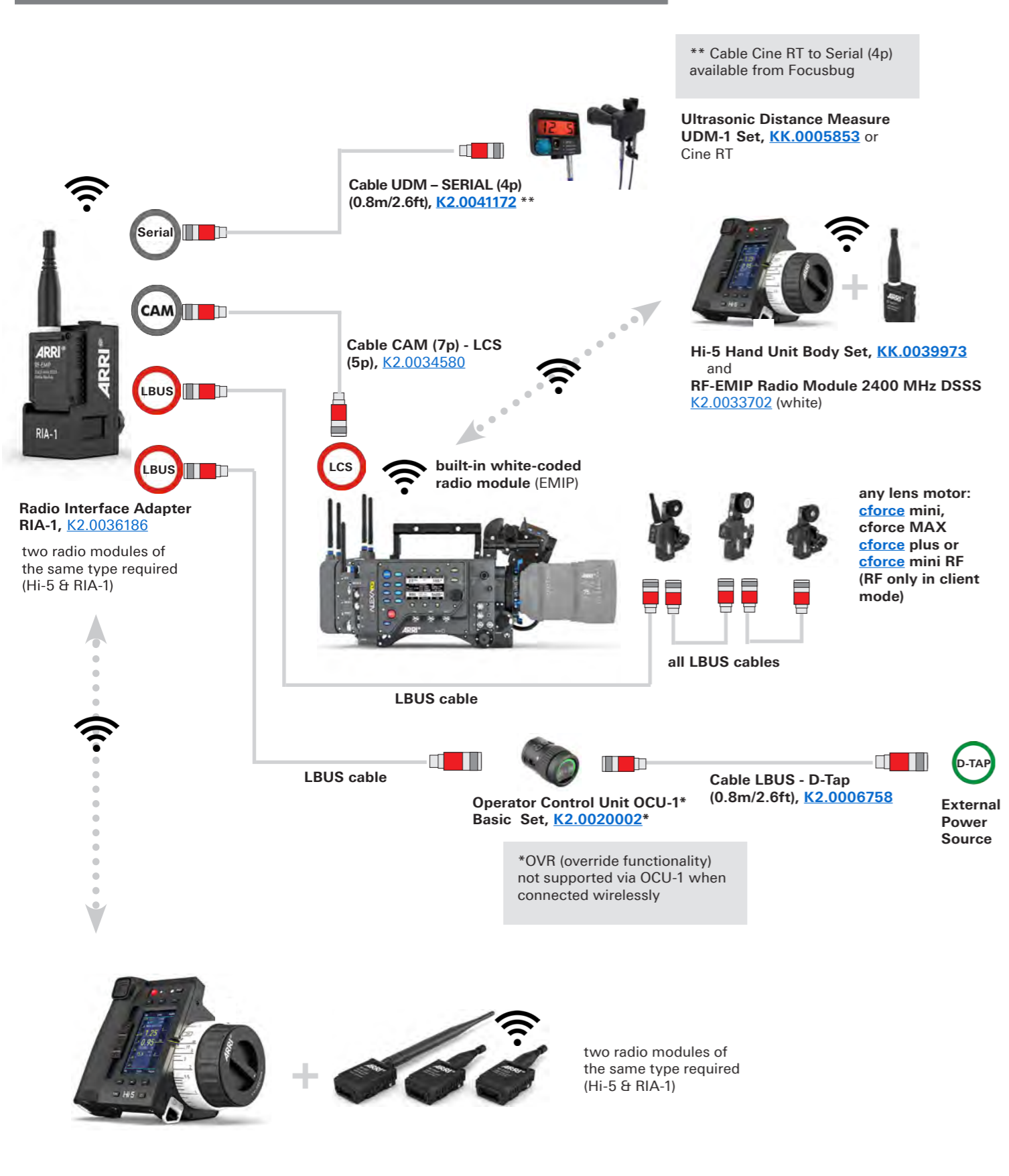

ALEXA LF / ALEXA 65 & OCU-1 & UDM-1

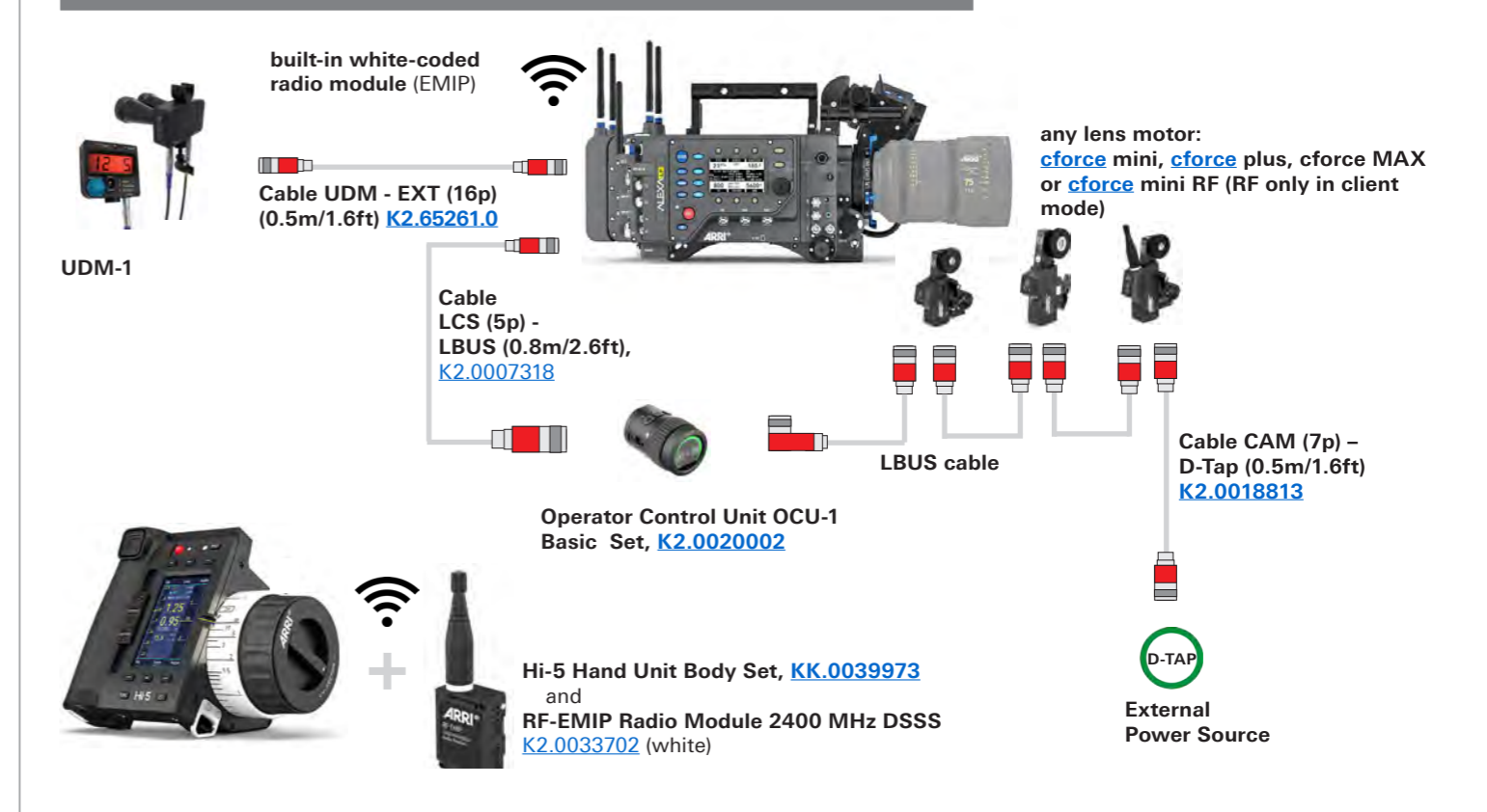

ALEXA LF / ALEXA 65 & RIA-1 & UDM & CLM motors

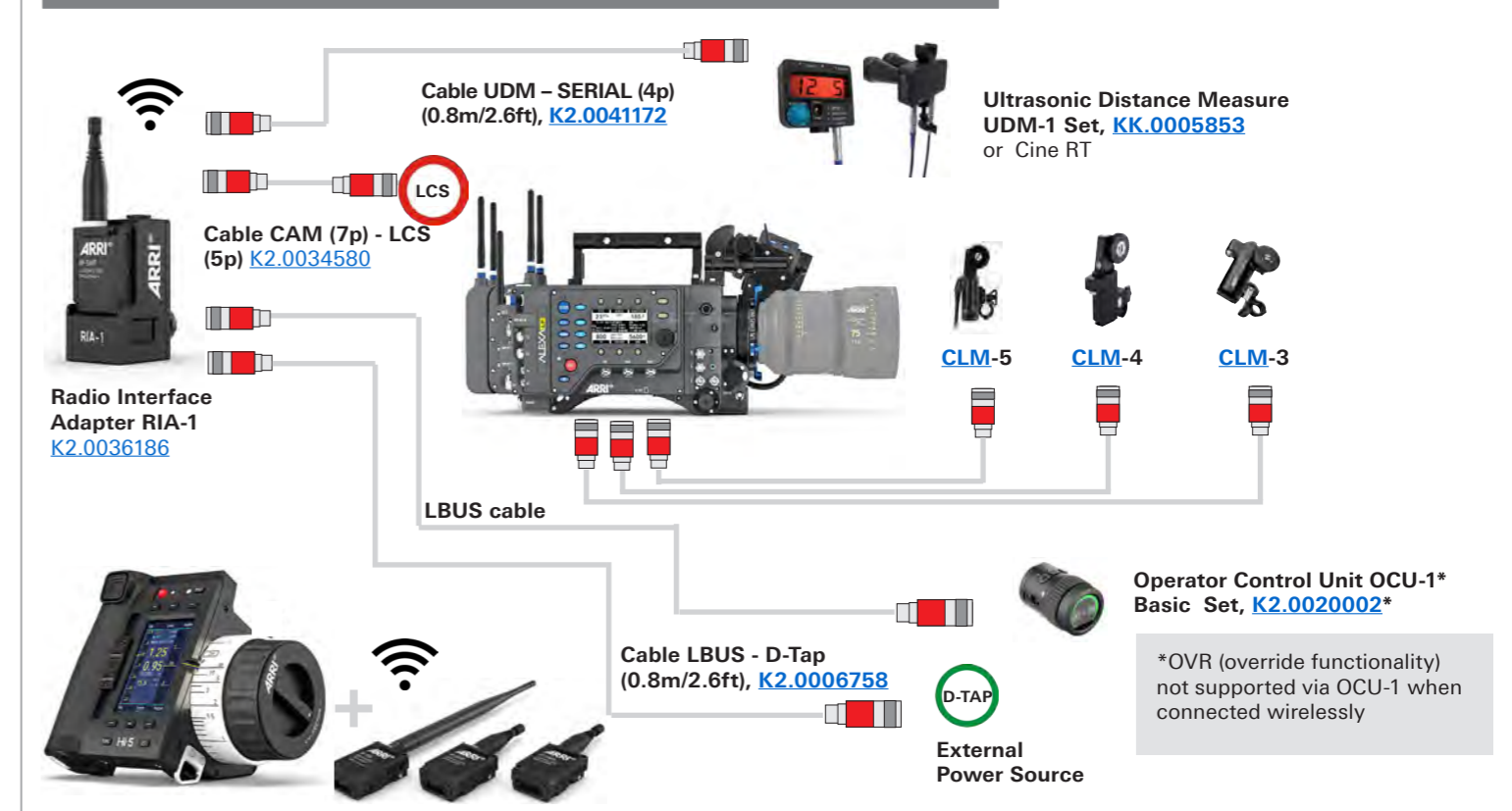

Hi-5 and RIA-1 - Sample Configurations Amira



Configuration Overview | 4.1.7 / 2026.04

Amira or 3rd Party Cameras & cforce mini RF motor

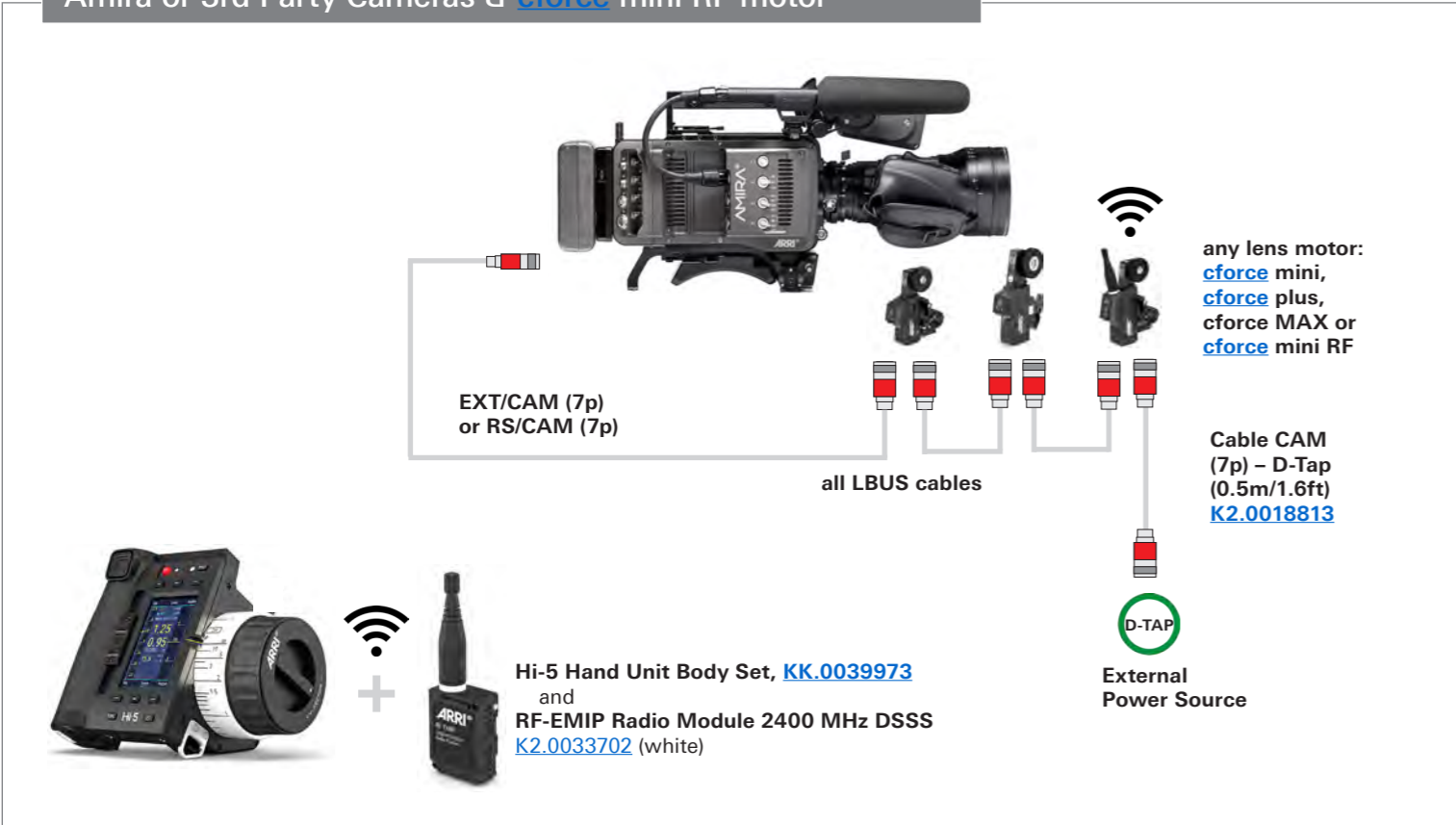

Amira & WCU-4



Amira or 3rd Party Cameras & cforce motors



Amira & RIA-1 & OCU-1 or Master Grips and LBUS control units

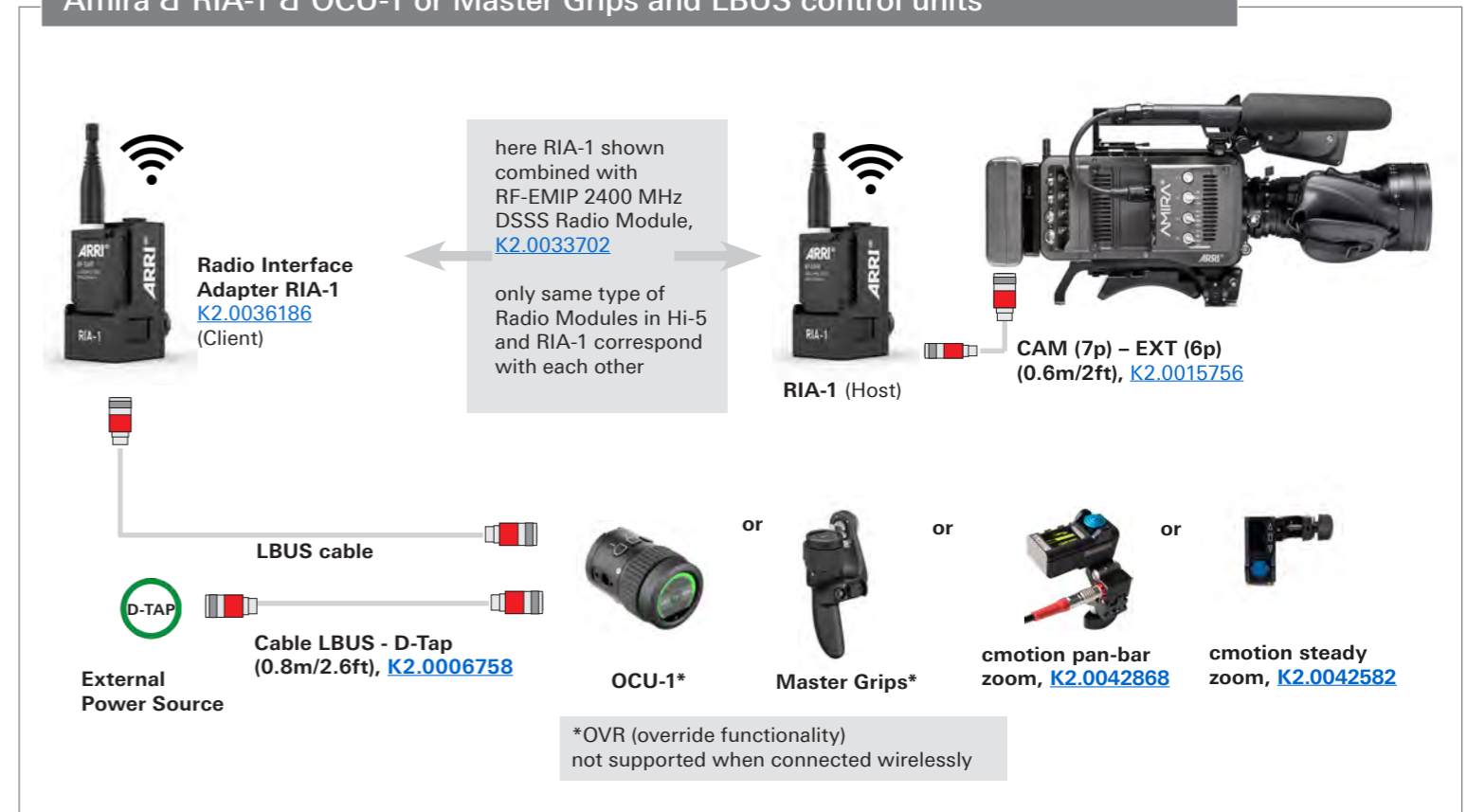

Hi-5 and RIA-1 - Sample Configurations 3rd Party



Configuration Overview | 4.1.8 / 2026.04

Components Configuration



3rd Party Cameras or Amira & UMC-4

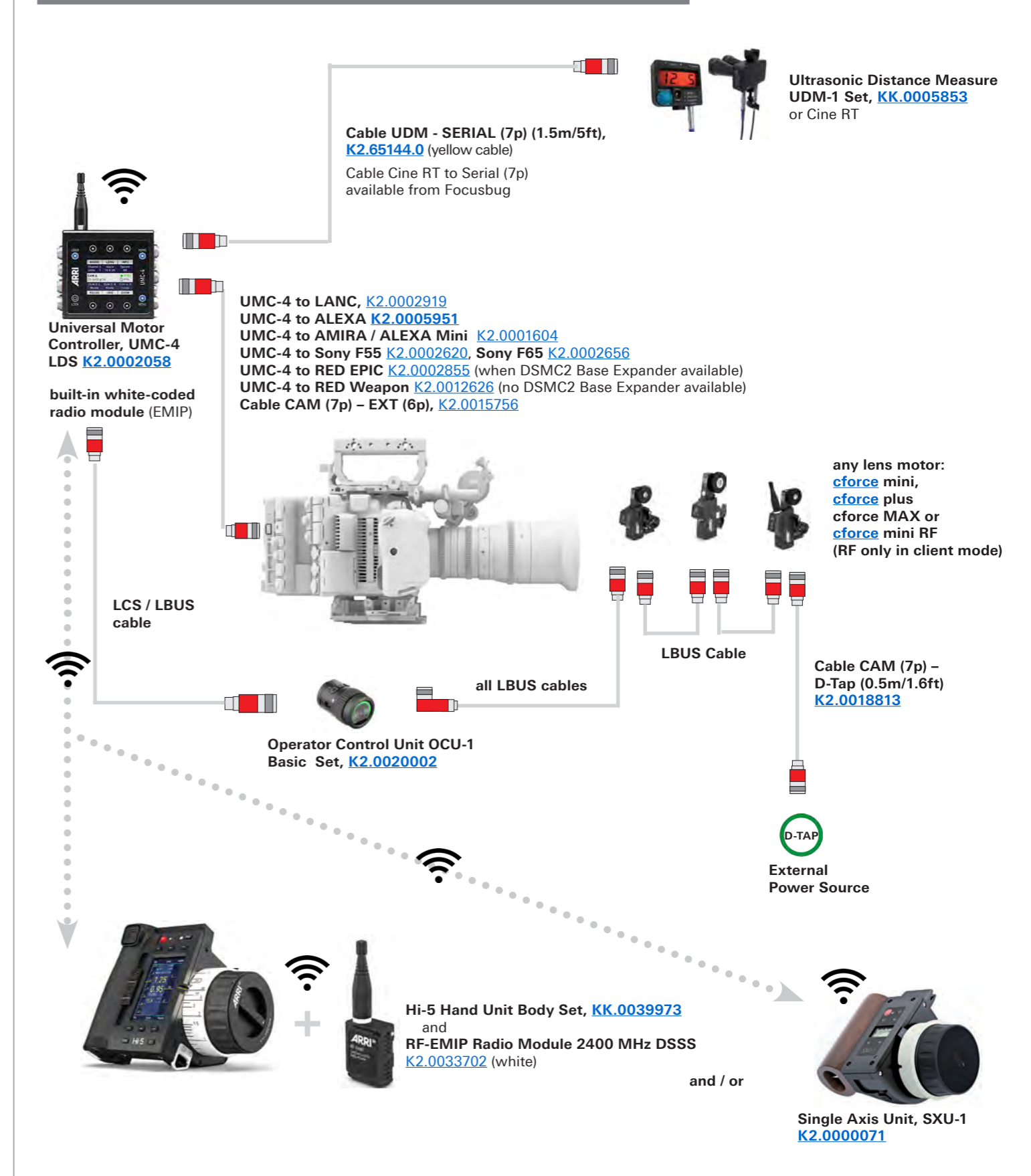

3rd Party & RIA-1 & OCU-1 or Master Grips and LBUS control units



Hi-5 and RIA-1 - Sample Configurations ALEXA Mini



Configuration Overview | 4.1.9 / 2026.04

ALEXA Mini / ALEXA Mini LF with OCU-1



ALEXA Mini / ALEXA Mini LF

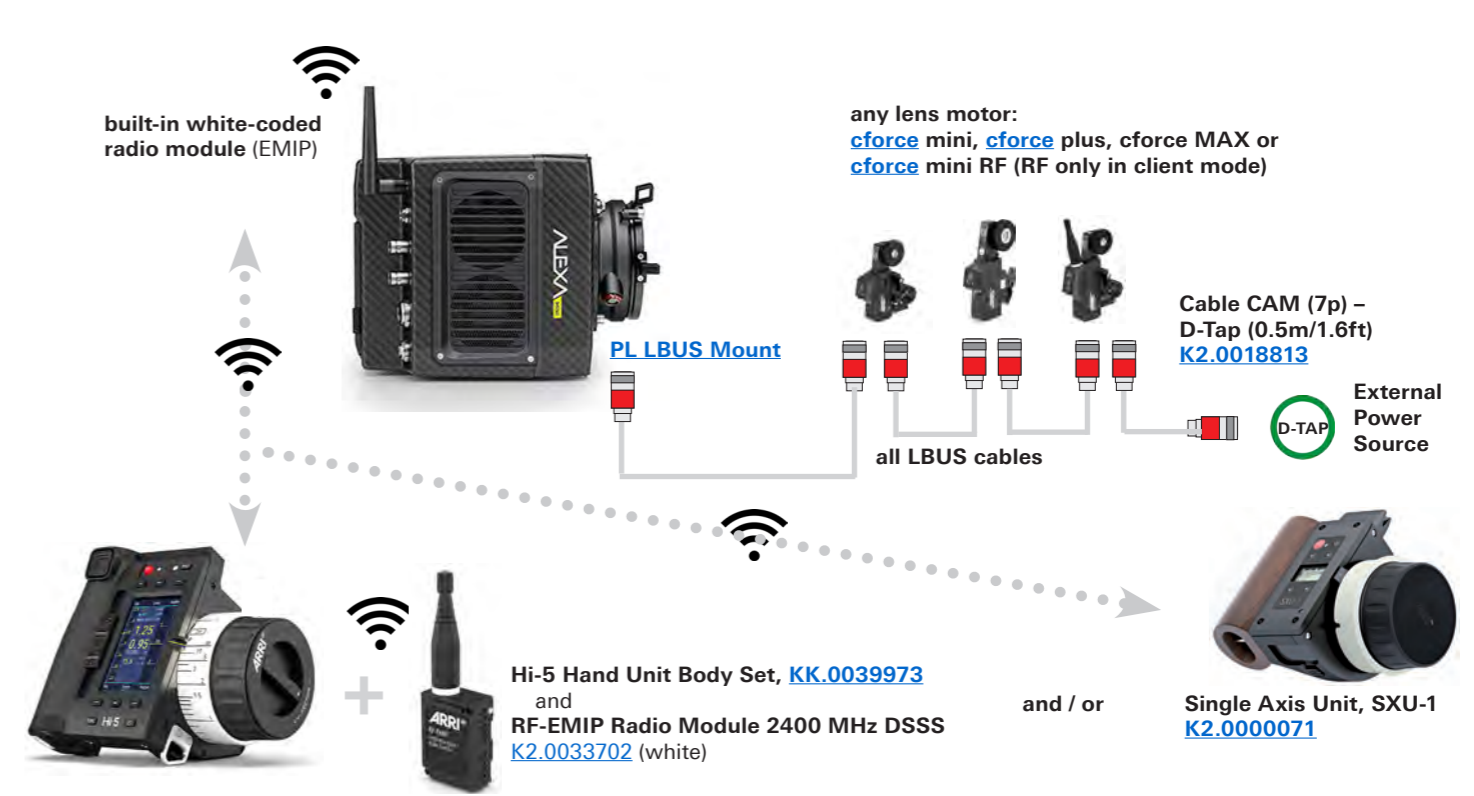

ALEXA Mini with RIA-1



ALEXA Mini with RIA-1 & UDM-1



ZMU-4 & Sample Configurations ALEXA 35



Configuration Overview | 4.2.0 / 2026.04

ZMU-4 Set



ZMU-4 Basic Set, [KK.0043770](#)

includes:
[K2.0039926](#) 1x ZMU-4 Zoom Main Unit Body
[K2.0033702](#) 1x RF-EMIP Radio Module 2400 MHz DSSS
[K2.0041744](#) 1x Rosette Adapter RA-7
[K2.0044203](#) 1x Rosette Adapter RA-8
[K2.0044543](#) 1x ZMU-4 ARRI Rosette

ZMU-4 Single Items & Accessories



ZMU-4 Body, [K2.0039926](#)
incl. RF Cover [K2.0039965](#)



RF-Cover
[K2.0039965](#)



Rosette Ad-
apter RA-7,
[K2.0041744](#)



Rosette Adapter
RA-8, [K2.0044203](#)



ZMU-4 ARRI
Rosette
[K2.0044543](#)



Li-Ion Battery Pack
LBP-3500, [K2.0036022](#)



LBP Battery Charger
[K2.0039874](#)

RIA & Radio Module Sets



RF-900 Radio Module 900 MHz FHSS
Set (2x), [KK.0039986](#) (grey)
includes:
[K2.0036599](#), RF-900 Radio Module
900 MHz FHSS (2x)



RF-EMIP Radio Module 2400 MHz DSSS
Set (2x), [KK.0039985](#) (white)
includes:
[K2.0033702](#), RF-EMIP Radio Module 2400
MHz DSSS (2x)



RF-2400 Radio Module 2400 MHz FHSS
Set (2x), [KK.0039984](#) (orange)
includes:
[K2.0036598](#), RF-2400 Radio Module 2400
MHz FHSS (2x)



Radio Interface Adapter RIA-1 Set,
[KK.0039980](#)
includes:
[K2.0036186](#) 1x Radio Interface Adapter RIA-1
[K2.0039465](#) 1x RIA-1 Bracket

ALEXA 35 Camera with ZMU-4 and Hi-5 hardwired



ZMU-4 Body
[K2.0039926](#)
for Zoom Control



RF-EMIP Radio
Module 2400 MHz
DSSS, [K2.0033702](#)
(white)



any lens motor:
[cforce mini](#), [cforce plus](#), [cforce MAX](#) or
[cforce mini RF](#) (RF only in client mode)

all LBUS cables



Hi-5 Hand Unit Body Set
[KK.0039973](#)
for Focus & Iris Control



Hi-5 SX Body Kit
[KK.0051704](#)

ALEXA 35 Camera with ZMU-4 and Hi-5 wireless



ZMU-4 Body
[K2.0039926](#)
for Zoom Control



RF-EMIP Radio Module
2400 MHz DSSS Set
[KK.0039985](#) (white)



any lens motor:
[cforce mini](#), [cforce plus](#), [cforce MAX](#) or
[cforce mini RF](#) (RF only in client mode)

all LBUS cables



Hi-5 Hand Unit Body Set
[KK.0039973](#)
Radio Module needed
for Focus & Iris Control



Hi-5 SX Body Kit
[KK.0051704](#)

ZMU-4 & Sample Configurations ALEXA 35 / ALEXA Mini / ALEXA Mini LF



Configuration Overview | 4.2.1 / 2026.04

ALEXA 35 Camera with ZMU-4 and Hi-5

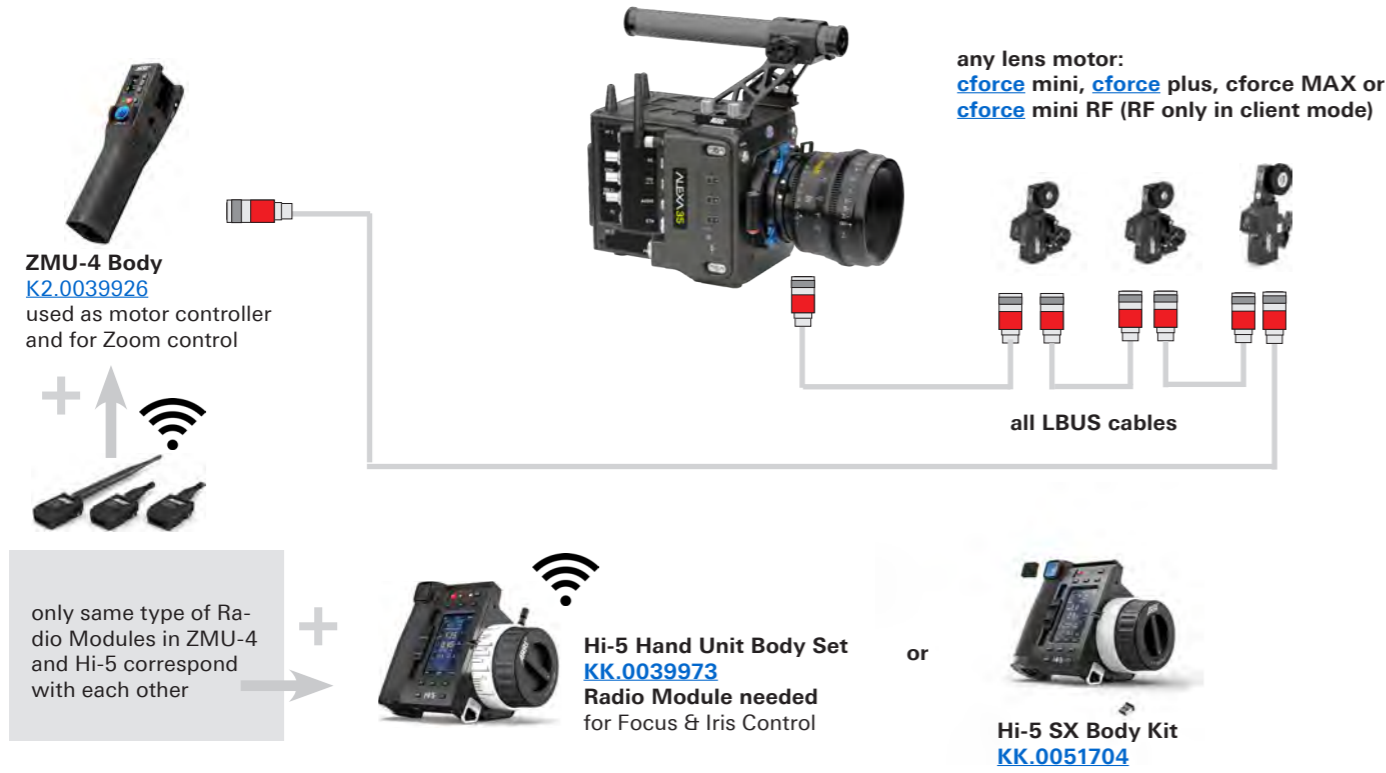

ALEXA Mini / ALEXA Mini LF with ZMU-4 & OCU-1 wireless



ALEXA Mini / ALEXA Mini LF with ZMU-4 hardwired

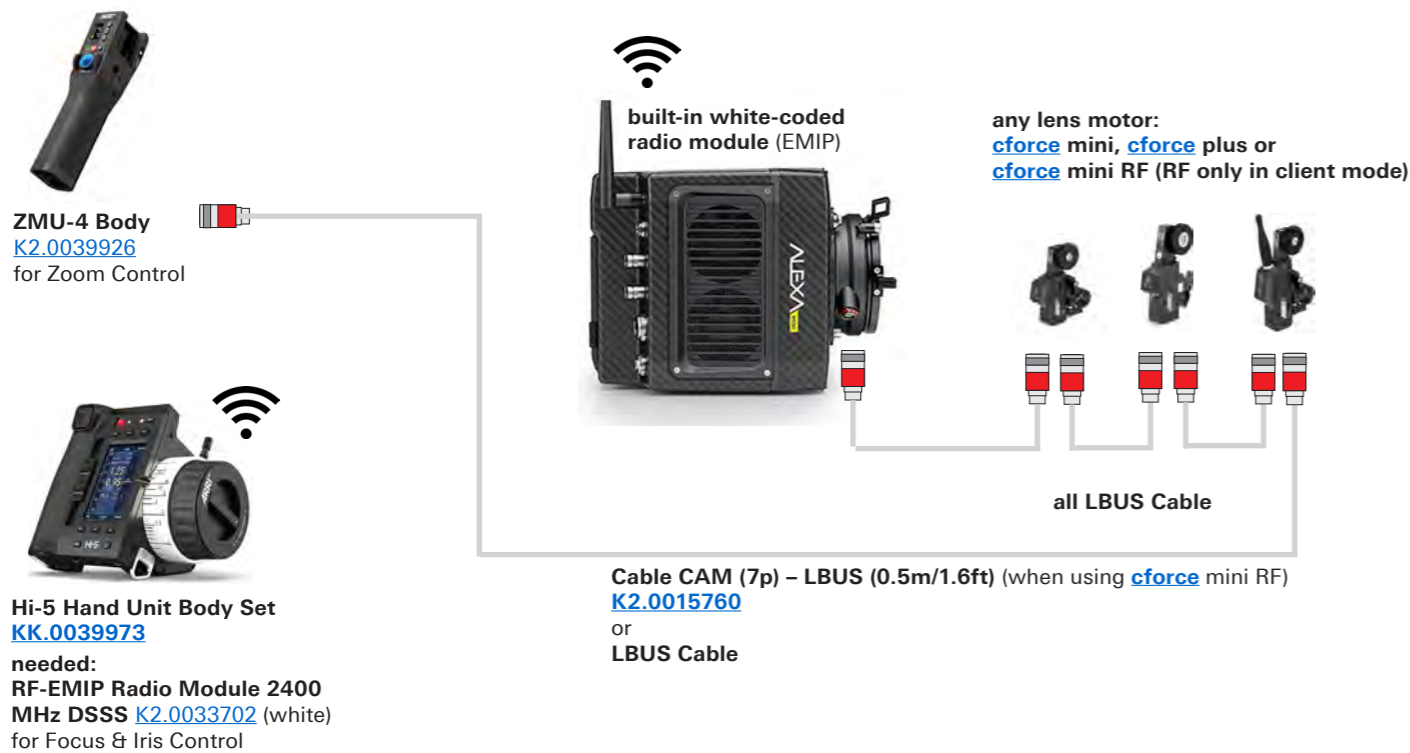

ALEXA Mini / ALEXA Mini LF with ZMU-4 wireless

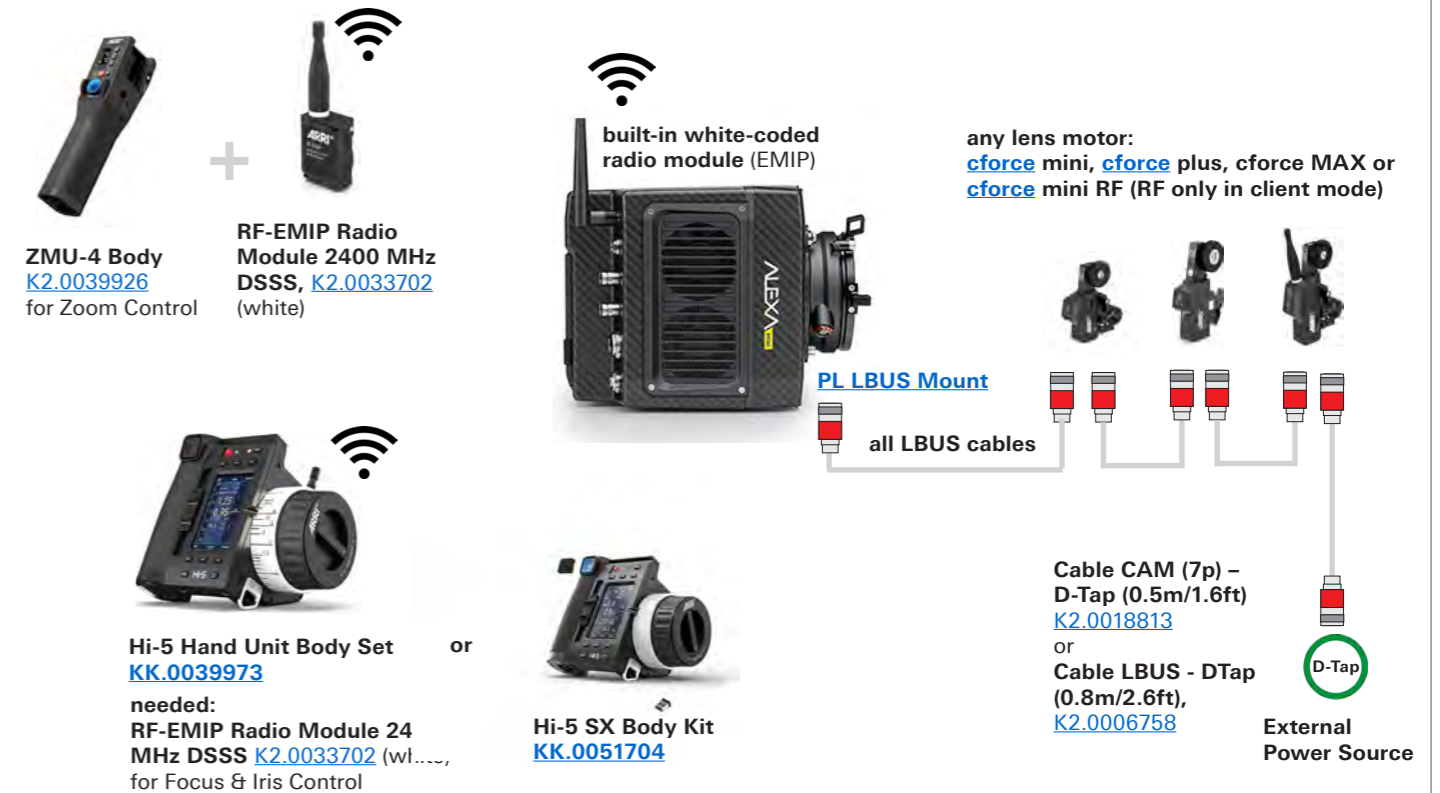

ZMU-4 & Sample Configurations 3rd Party



Configuration Overview | 4.2.2 / 2026.04

3rd Party Camera with **cforce** mini RF and ZMU-4 wireless

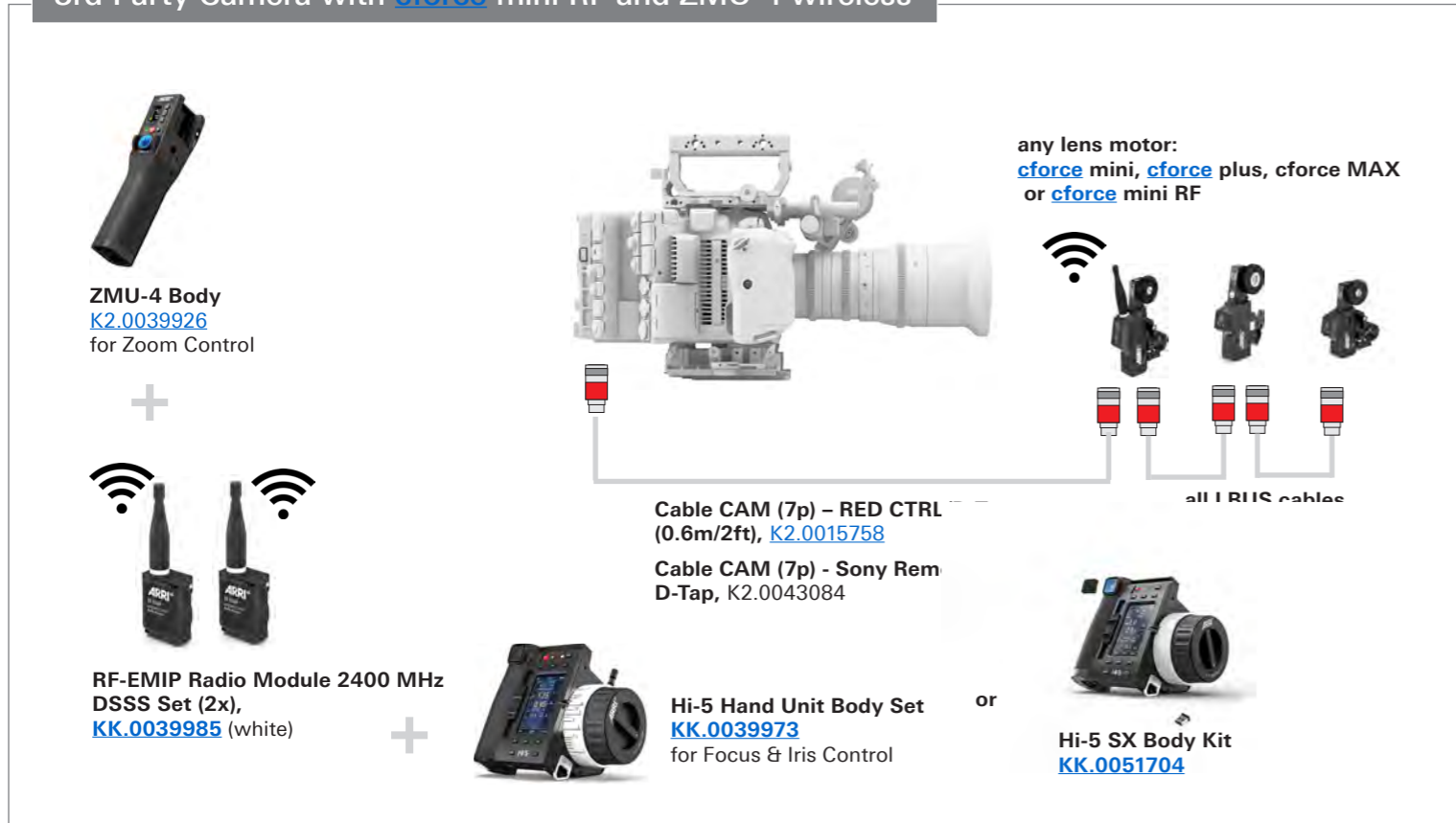

3rd Party Camera with RIA-1 and ZMU-4 wireless

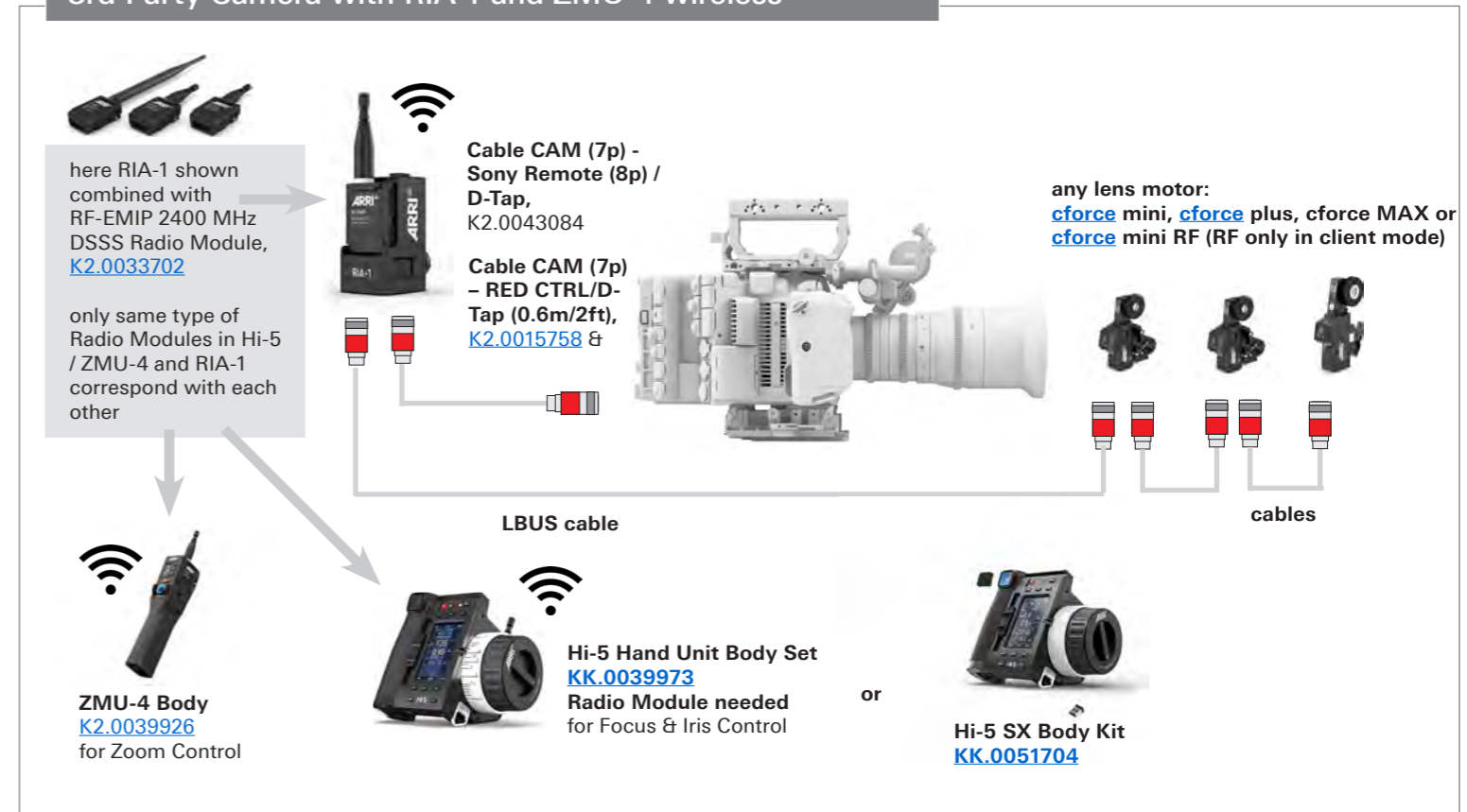

3rd Party Camera with ZMU-4 hardwired

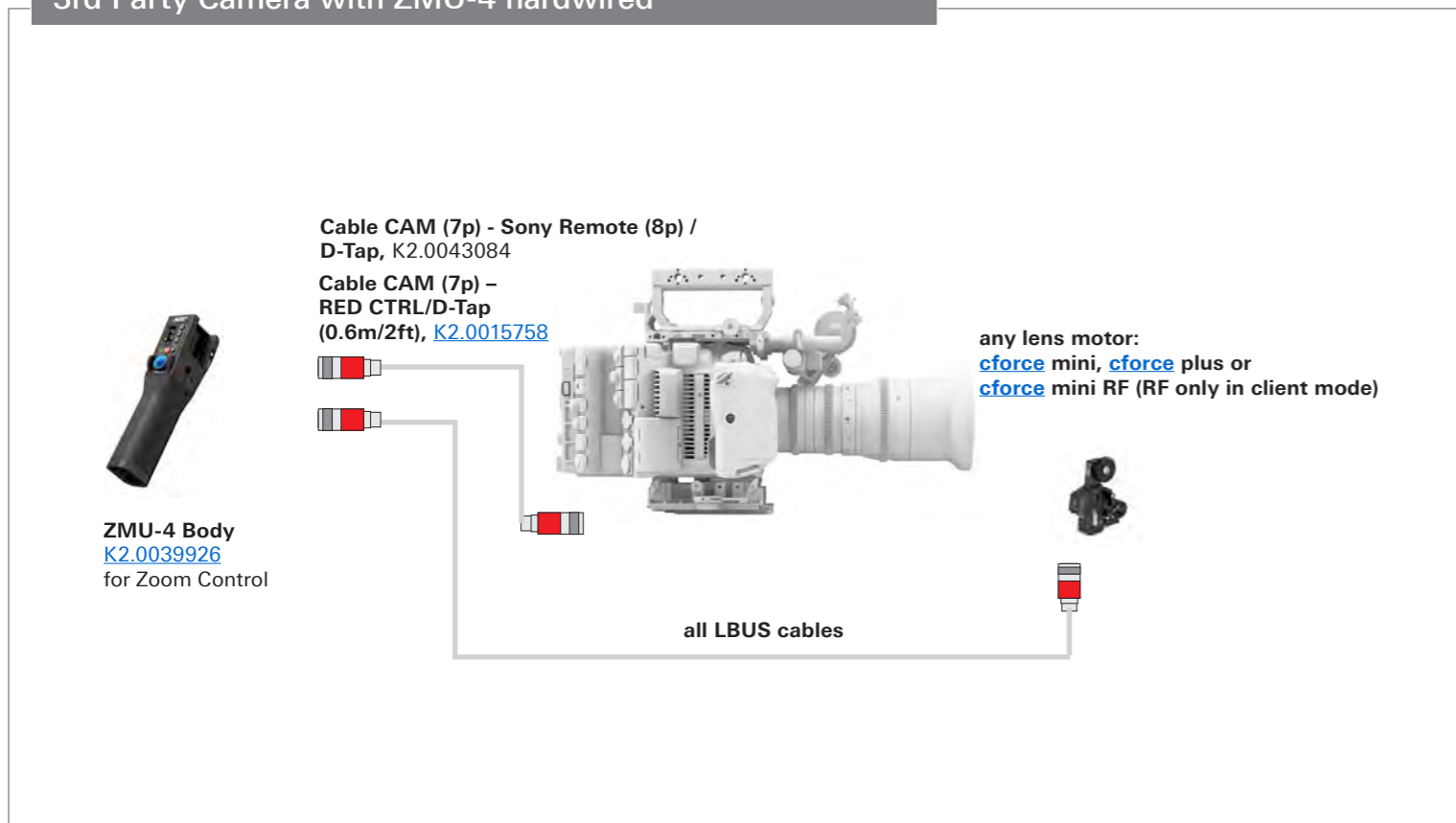

3rd Party Camera with ZMU-4 hardwired and Hi-5

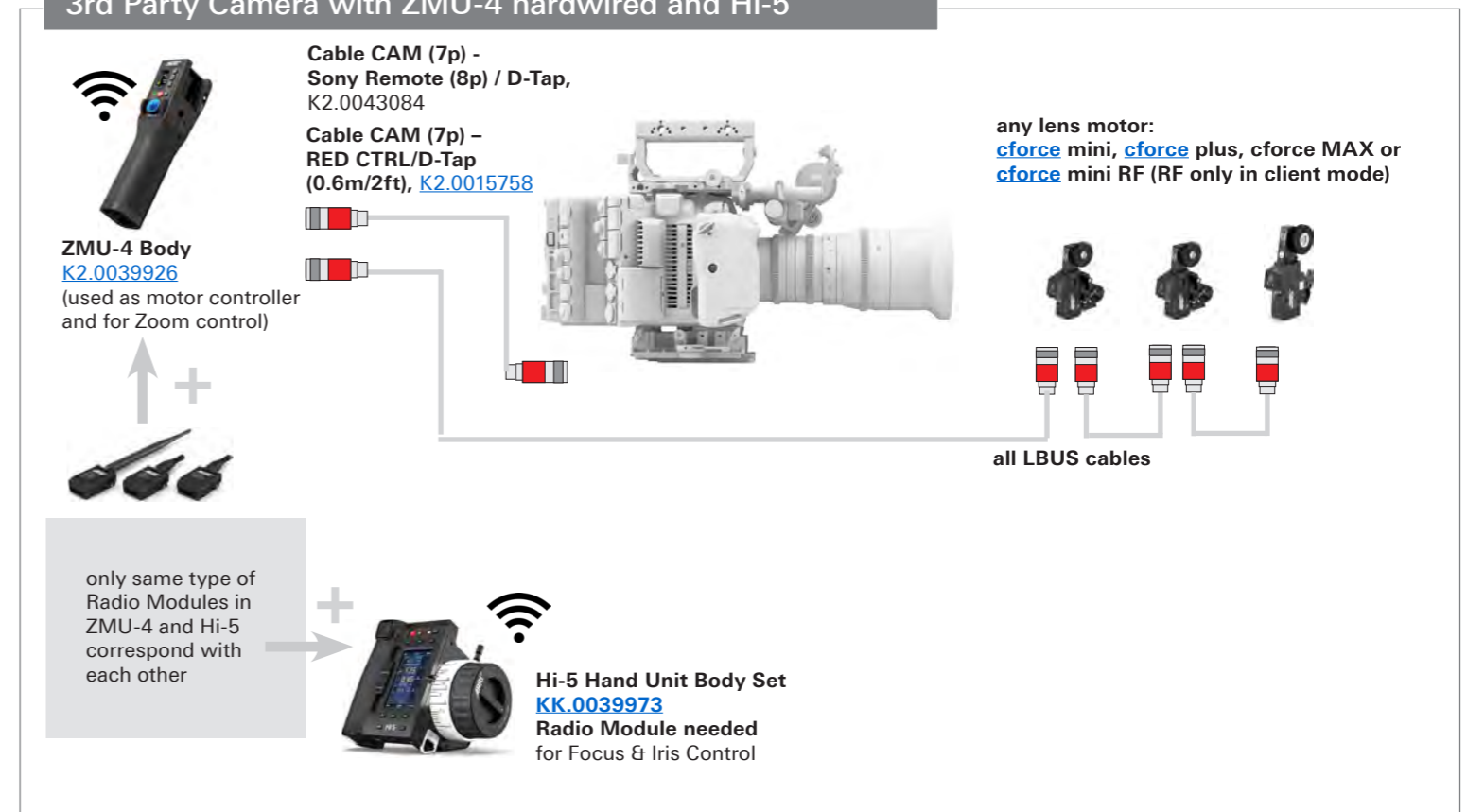

ZMU-4 - Cable Guide



Configuration Overview | 4.2.3 / 2025.10

Item Number	Cable Name	Supported Cameras	Camera Control		
			Run/Stop?	on Hi-5	on WCU-4
K2.0025027	Cable CAM (7p) – LBUS (0.3m/1ft)	ALEXA 35	Yes	Yes	Yes
K2.0015760	Cable CAM (7p) – LBUS (0.5m/1.6ft)	ALEXA 35	Yes	Yes	Yes
K2.0015756	Cable CAM (7p) – EXT (6p) (0.6m/2ft)	ALEXA Mini, ALEXA Mini LF, AMIRA	Yes	Yes	Yes
K2.0015755	Cable CAM (7p) – EXT (16p) (0.8m/2.6ft)	ALEXA Classic EV, ALEXA XT EV, ALEXA SXT EV. Only works with ALEXA EV cameras, not ALEXA Plus	Yes	Yes	Yes
K2.0034580	Cable CAM (7p) - LCS (5p) (0.8m/2.6ft)	ALEXA Plus cameras including ALEXA Plus, ALEXA XT Plus, ALEXA SXT Plus, ALEXA LF, ALEXA 65	Yes	Yes	Yes
K2.0015758	Cable CAM (7p) – RED CTRL/D-Tap (0.6m/2ft)	RED DSMC2 cameras except those with Base Expander Module. RED DSMC3 cameras (Komodo/V-Raptor) with module or break-out cable from 9p Lemo EXT Connector to RED CTRL connector. Supports run/stop/tally on WCU-4 and Hi-5. Additional RED Camera Control License Key required for further camera control on Hi-5	Yes	Yes	No
K2.0015757	Cable CAM (7p) – LANC/D-Tap (0.6m/2ft)	Many cameras with a LANC connector including Canon C300/C500 series, Sony PXW-FX9/FS7 and Blackmagic Ursa Mini Pro	Yes	No	No
K2.0018814	Cable CAM (7p) – Sony Venice/F55 CTRL/D-Tap (0.6m/2ft)	Sony F5/F55 and Sony Venice. Not compatible with Sony Venice 2, Panasonic Varicam, Panasonic Varicam LT	Yes	No	No
K2.0047268	Cable CAM (7p) - Sony Remote (8p)/D-Tap (0.8m/2.6ft)	Run/stop/tally for Sony Venice and Venice 2. Additional camera control supported on Hi-5 with Sony Camera Control License Key for Hi-5	Yes	Yes	No
K2.0015754	Cable CAM (7p) – RS (0.3m/1ft)	Run/stop/tally on all ARRI Cameras and any camera that supports run/stop via a 3p Fischer connector. Can also be used power the RIA-1 without any camera connection	Yes	No	No
K2.0018813	Cable CAM (7p) – D-Tap (0.5m/1.6ft)	For powering the RIA-1 without any camera connection	No	No	No
K2.0023832	Cable CAM (7p, f) – CAM (7p, m) (0.3m/1ft)	Extension cable for any CAM cable	N/A	N/A	N/A
K2.0015759	Cable CAM (7p) – ENG (12p) (0.3m/1ft)	Can be used to inject lens metadata into Sony Venice and Venice 2 LENS connector.	N/A	N/A	N/A

Note: Sony and RED Camera Control Licenses required for camera control on Hi-5. ALEXA Remote License Key required for ALEXA/AMIRA camera control on WCU-4.

Master Grips Sets

Note: **cforce** motors, respective LBUS cables and 15mm rods/supporting hardware not included!

For sets with Standard Grips please contact your local dealer



Master Grip Prime Set for AMIRA K0.0013095
includes:
Master Grip Right Wheel MRW-1 [K2.0009494](#)
Master Grip Left Wheel MLW-1 [K2.0009363](#)
Handgrip Extension 160 mm (2x) [K2.0012911](#)
Cable Clip 15 mm (2x) [K2.0012921](#)
Extension Tube for Handgrip [K2.47136.0](#)
Rod Mounting Bracket RMB-4 [K2.0013007](#)
15 mm Reduction Insert [K2.66255.0](#)
Cable LBUS (angled) to AMIRA EXT (straight) 80 cm [K2.0012628](#)
Cable LBUS (angled) to LBUS (angled) 60 cm [K2.0013040](#)
Master Grip Case [K2.0012965](#)

Master Grip Prime Set for ALEXA Plus/Studio K0.0013090
includes:
Master Grip Right Wheel MRW-1 [K2.0009494](#)
Master Grip Left Wheel MLW-1 [K2.0009363](#)
Handgrip Extension 160 mm (2x) [K2.0012911](#)
Cable Clip 15 mm (2x) [K2.0012921](#)
Extension Tube for Handgrip [K2.47136.0](#)
Cable LBUS (angled) to LCS 80 cm [K2.0013044](#)
Cable LBUS (angled) to LBUS (angled) 60 cm [K2.0013040](#)
Master Grip Case [K2.0012965](#)

Master Grip Zoom Set for ALEXA Plus/Studio K0.0013094
includes:
Master Grip Right Rocker MRR-1 [K2.0009493](#)
Master Grip Left Wheel MLW-1 [K2.0009363](#)
Handgrip Extension 160 mm (2x) [K2.0012911](#)
Cable Clip 15 mm (2x) [K2.0012921](#)
Extension Tube for Handgrip [K2.47136.0](#)
Cable LBUS (angled) to LCS 80 cm [K2.0013044](#)
Cable LBUS (angled) to LBUS (angled) 60 cm [K2.0013040](#)
Master Grip Case [K2.0012965](#)

Master Grip Prime Set for ALEXA Mini K0.0013093
includes:
Master Grip Right Wheel MRW-1 [K2.0009494](#)
Master Grip Left Wheel MLW-1 [K2.0009363](#)
Handgrip Extension 160 mm (2x) [K2.0012911](#)
Cable Clip 15 mm (2x) [K2.0012921](#)
Extension Tube for Handgrip [K2.47136.0](#)
Cable LBUS (angled) to LBUS (straight) 35 cm [K2.0013042](#)
Cable LBUS (angled) to LBUS (angled) 60 cm [K2.0013040](#)
Master Grip Case [K2.0012965](#)

Master Grip Zoom Set for ALEXA Mini K0.0013089
includes:
Master Grip Right Rocker MRR-1 [K2.0009493](#)
Master Grip Left Wheel MLW-1 [K2.0009363](#)
Handgrip Extension 160 mm (2x) [K2.0012911](#)
Cable Clip 15 mm (2x) [K2.0012921](#)
Extension Tube for Handgrip [K2.47136.0](#)
Cable LBUS (angled) to LBUS (straight) 35 cm [K2.0013042](#)
Cable LBUS (angled) to LBUS (angled) 60 cm [K2.0013040](#)
Master Grip Case [K2.0012965](#)

Master Grip Zoom Set for AMIRA K0.0013088
includes:
Master Grip Right Rocker MRR-1 [K2.0009493](#)
Master Grip Left Wheel MLW-1 [K2.0009363](#)
Handgrip Extension 160 mm (2x) [K2.0012911](#)
Cable Clip 15 mm (2x) [K2.0012921](#)
Extension Tube for Handgrip [K2.47136.0](#)
Rod Mounting Bracket RMB-4 [K2.0013007](#)
15 mm Reduction Insert [K2.66255.0](#)
Cable LBUS (angled) to AMIRA EXT (straight) 80 cm [K2.0012628](#)
Cable LBUS (angled) to LBUS (angled) 60 cm [K2.0013040](#)
Master Grip Case [K2.0012965](#)

Master Grip Prime Set for 3rd-Party Cameras K0.0013091
includes:
Master Grip Right Wheel MRW-1 [K2.0009494](#)
Master Grip Left Wheel MLW-1 [K2.0009363](#)
Handgrip Extension 160 mm (2x) [K2.0012911](#)
Cable Clip 15 mm (2x) [K2.0012921](#)
Extension Tube for Handgrip [K2.47136.0](#)
LCUBE CUB-1 [K2.0008630](#)
LCUBE Bracket [K2.0009620](#)
Cable LBUS (angled) to LBUS (angled) 60 cm [K2.0013040](#)
Cable CUB-1 to F5/55 cameras [K2.0012631](#)
Cable CUB-1 to RED cameras [K2.0012632](#)
Cable CUB-1 to LANC [K2.0012633](#)
Master Grip Case [K2.0012965](#)

Master Grip Zoom Set for 3rd-Party Cameras K0.0013092
includes:
Master Grip Right Rocker MRR-1 [K2.0009493](#)
Master Grip Left Wheel MLW-1 [K2.0009363](#)
Handgrip Extension 160 mm (2x) [K2.0012911](#)
Cable Clip 15 mm (2x) [K2.0012921](#)
Extension Tube for Handgrip [K2.47136.0](#)
LCUBE CUB-1 [K2.0008630](#)
LCUBE CUB-2 [K2.0010681](#)
LCUBE Bracket (2x) [K2.0009620](#)
Cable LBUS (angled) to LBUS (angled) 60 cm [K2.0013040](#)
Cable CUB-1 to F5/55 cameras [K2.0012631](#)
Cable CUB-1 to LANC [K2.0012632](#)
Master Grip Case [K2.0012633](#)
[K2.0012965](#)

Master Grips Single Parts



Master Grip Left Wheel MLW-1 [K2.0009363](#)



Master Grip Right Wheel MRW-1 [K2.0009494](#)



Master Grip Left Rocker MLR-1 [K2.0009490](#)



Master Grip Right Rocker MRR-1 [K2.0009493](#)



Standard Grip Left SGL-1, [K2.0016317](#)



Standard Grip Right SGR-1, [K2.0016318](#)



Handgrip Extension 80 mm, [K2.0012913](#)



Handgrip Extension 160 mm, [K2.0012911](#)



Handgrip Extension 240 mm, [K2.0012917](#)



Extension Tube [K2.47136.0](#)



Pan Bar Adapter 18 mm, [K2.0012918](#)



Pan Bar Adapter 20 mm, [K2.0012919](#)



Pan Bar Clamp [K2.0012920](#)



Master Grip case [K2.0012965](#)



Rod Mounting Bracket RMB-4, [K2.0013007](#)



15 mm Cable Clip [K2.0012921](#)



LCUBE CUB-2 Basic Set [KK.0013217](#)



LCUBE - CUB-1 (Basic Set) [KK.0009001](#)

Cables



Cable LBUS (angled) to AMIRA EXT (straight) Length: 0.8m/2.6ft, [K2.0012628](#)
Cable LBUS (angled) to LCS Length: 0.80m/2.6ft, [K2.0013044](#)

Cable LBUS (angled) to LBUS (straight) Length: 0.35m/1.1ft, [K2.0013042](#)
Cable LBUS (angled) to LBUS (straight) Length: 0.80m/2.6ft, [K2.0013043](#)
Cable LBUS (angled) to LBUS (straight) Length: 1m/3.3ft, [K2.0013041](#)
Cable LBUS (angled) to LBUS (angled) Length: 0.2m/8", [K2.0012785](#)
Cable LBUS (angled) to LBUS (angled) Length: 0.6m/2ft, [K2.0013040](#)
Cable LBUS (angled) to LBUS (angled) Length: 0.8m/2.6ft, [K2.0012630](#)

Cable LENS/ENG (12p) - Hi (12p) analog, [K2.0022328](#)

for further LBUS cables (angled or straight) please contact your local dealer.

Master Grips - Sample Configurations ALEXA / 3rd Party Camera



Configuration Overview | 4.3.1 / 2026.04

ALEXA Plus / Studio - Cine Style Lens



3rd Party Camera - Cine Lens

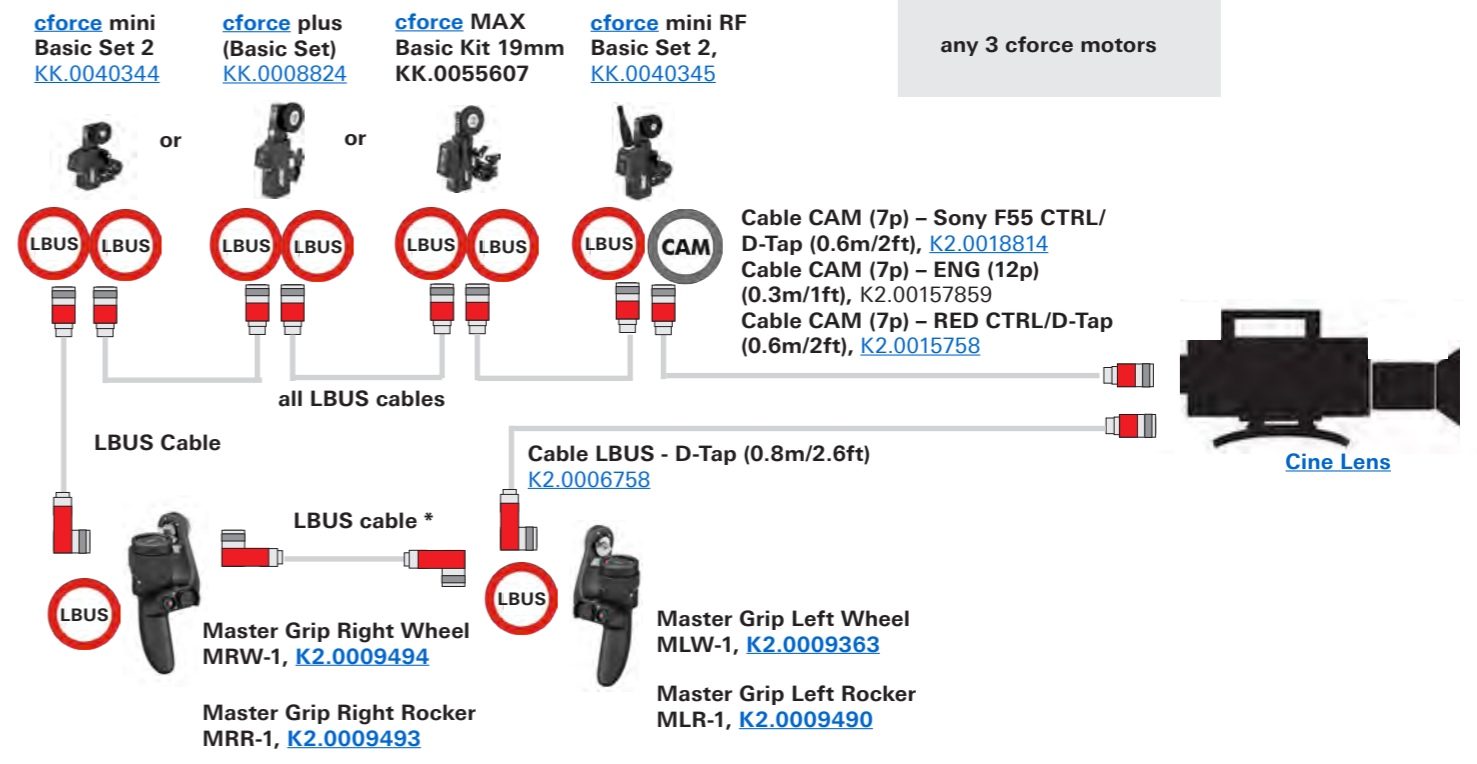

LBUS Cables

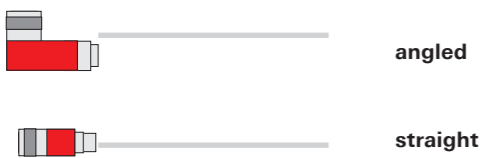

LBUS cables need to be ordered separately

- Cable LBUS (straight) to LBUS (straight) Length: 0.2m/8", [K2.0006749](#)
- Cable LBUS (straight) to LBUS (straight) Length: 0.3m/1ft, [K2.0006750](#)
- Cable LBUS (straight) to LBUS (straight) Length: 0.5m/1.5ft, [K2.0006751](#)
- Cable LBUS (straight) to LBUS (straight) Length: 0.8m/2.5ft, [K2.0006752](#)
- Cable LBUS (straight) to LBUS (straight) Length: 1.5m/5ft, [K2.0006753](#)
- Cable LBUS (straight) to LBUS (straight) Length: 3m/10ft, [K2.0006754](#)
- Cable LBUS (straight) to LBUS (straight) Length: 6m/20ft, [K2.0006755](#)
- Cable LBUS (straight) to LBUS (straight) Length: 15m/49ft, [K2.0006756](#)
- Cable LCS (5p) - LBUS (0.8m/2.6ft): [K2.0007318](#)
- Cable LBUS (angled) to LBUS (straight) Length: 0.35m/1.1ft, [K2.0013042](#)
- Cable LBUS (angled) to LBUS (straight) Length: 0.80m/2.3ft, [K2.0013043](#)
- Cable LBUS (angled) to LBUS (straight) Length: 1m/3.3ft, [K2.0013041](#)
- Cable LBUS (angled) to LBUS (straight) Length: 0.3m/1", [K2.0051681](#)
- Cable LBUS (angled) to LBUS (angled) Length: 0.2m/8", [K2.0012785](#)
- Cable LBUS (angled) to LBUS (angled) Length: 0.6m/2ft, [K2.0013040](#)
- Cable LBUS (angled) to LBUS (angled) Length: 0.8m/2.6ft, [K2.0012630](#)

Cable LBUS Star (0.2m/8in). [K2.0023823](#)

Standard Grips & Extensions



3rd Party Camera - Servo Zoom Lens

Servo zoom control requires at least AMIRA/ALEXA Mini SUP 5.0

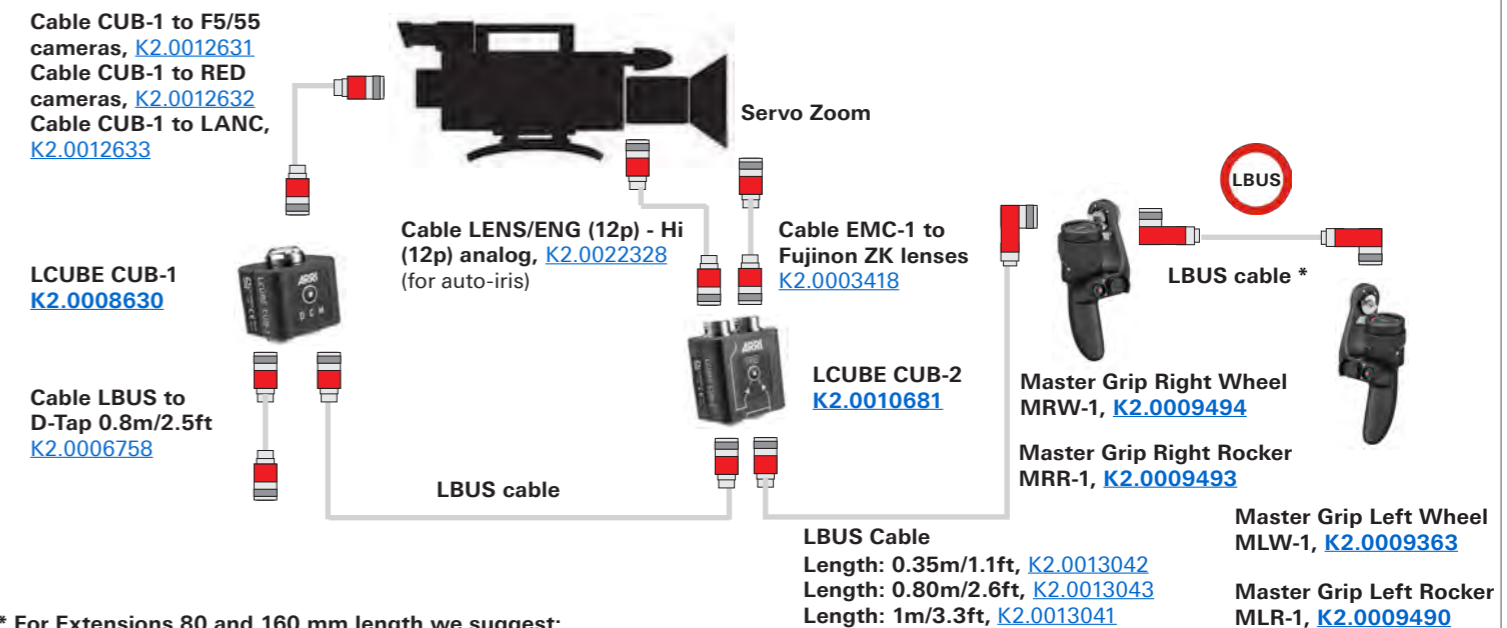

- * For Extensions 80 and 160 mm length we suggest: Cable LBUS (angled) to LBUS (angled) Length: 0.6m/2ft, [K2.0013040](#)
- * For Extensions 240 mm length we suggest: Cable LBUS (angled) to LBUS (angled) Length: 0.8m/2.6ft, [K2.0012630](#)

Master Grips - Sample Configurations AMIRA



Configuration Overview | 4.3.2 / 2026.04

AMIRA - Cine Style Lens



AMIRA - Servo Zoom Lens

Servo zoom control requires AMIRA/ALEXA Mini SUP 5.0



AMIRA - EF Lens

EF lens control requires AMIRA/ALEXA Mini SUP 5.0

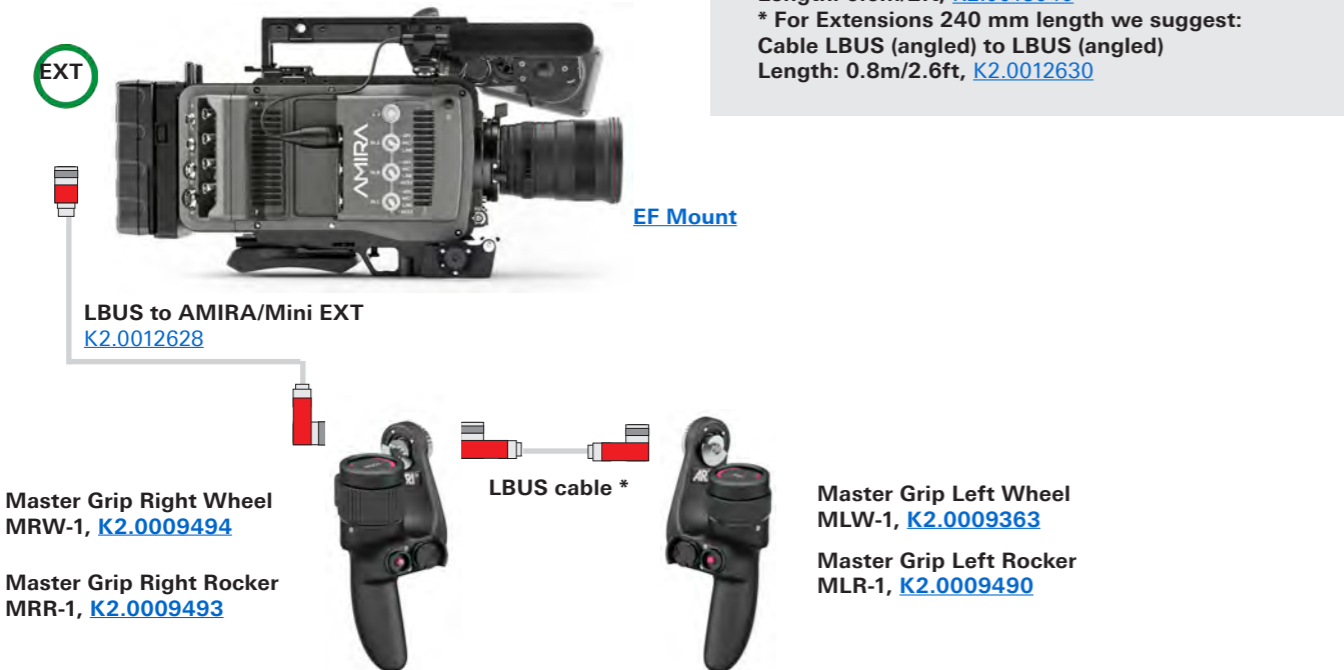

LBUS Cables



LBUS cables need to be ordered separately

- Cable LBUS (straight) to LBUS (straight) Length: 0.2m/8", [K2.0006749](#)
- Cable LBUS (straight) to LBUS (straight) Length: 0.3m/1ft, [K2.0006750](#)
- Cable LBUS (straight) to LBUS (straight) Length: 0.5m/1.5ft, [K2.0006751](#)
- Cable LBUS (straight) to LBUS (straight) Length: 0.8m/2.5ft, [K2.0006752](#)
- Cable LBUS (straight) to LBUS (straight) Length: 1.5m/5ft, [K2.0006753](#)
- Cable LBUS (straight) to LBUS (straight) Length: 3m/10ft, [K2.0006754](#)
- Cable LBUS (straight) to LBUS (straight) Length: 6m/20ft, [K2.0006755](#)
- Cable LBUS (straight) to LBUS (straight) Length: 15m/49ft, [K2.0006756](#)
- Cable LCS (5p) - LBUS (0.8m/2.6ft): [K2.0007318](#)

- Cable LBUS (angled) to LBUS (straight) Length: 0.35m/1.1ft, [K2.0013042](#)
- Cable LBUS (angled) to LBUS (straight) Length: 0.80m/2.3ft, [K2.0013043](#)
- Cable LBUS (angled) to LBUS (straight) Length: 1m/3.3ft, [K2.0013041](#)
- Cable LBUS (angled) to LBUS (straight) Length: 0.3m/1", [K2.0051681](#)
- Cable LBUS (angled) to LBUS (angled) Length: 0.2m/8", [K2.0012785](#)
- Cable LBUS (angled) to LBUS (angled) Length: 0.6m/2ft, [K2.0013040](#)
- Cable LBUS (angled) to LBUS (angled) Length: 0.8m/2.6ft, [K2.0012630](#)

Cable LBUS Star (0.2m/8in). [K2.0023823](#)

Standard Grips & Extensions



Master Grips - Sample Configurations ALEXA Mini



Configuration Overview | 4.3.3 / 2026.04

ALEXA Mini - Cine Style Lens

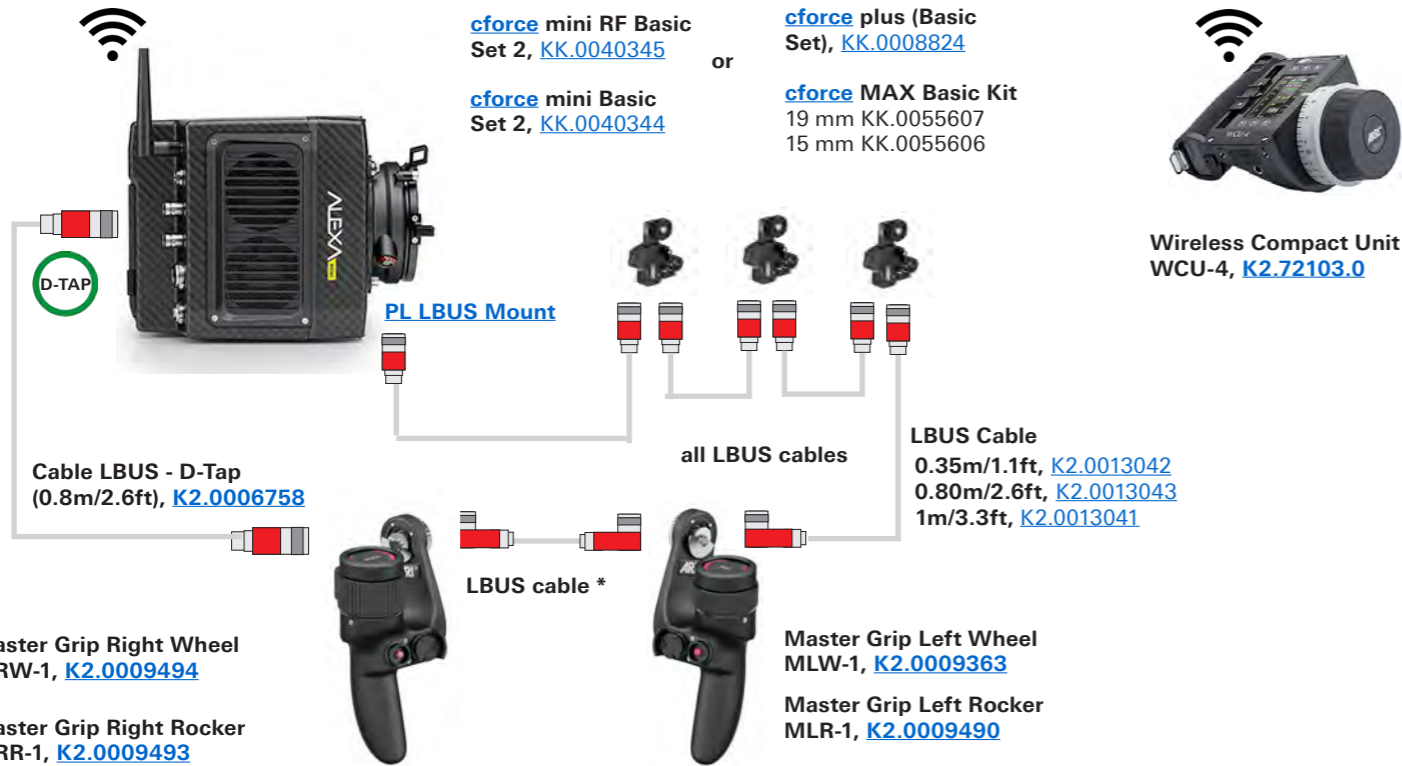

ALEXA Mini - Servo Zoom Lens

Servo zoom control requires at least AMIRA/ALEXA Mini SUP 5.0

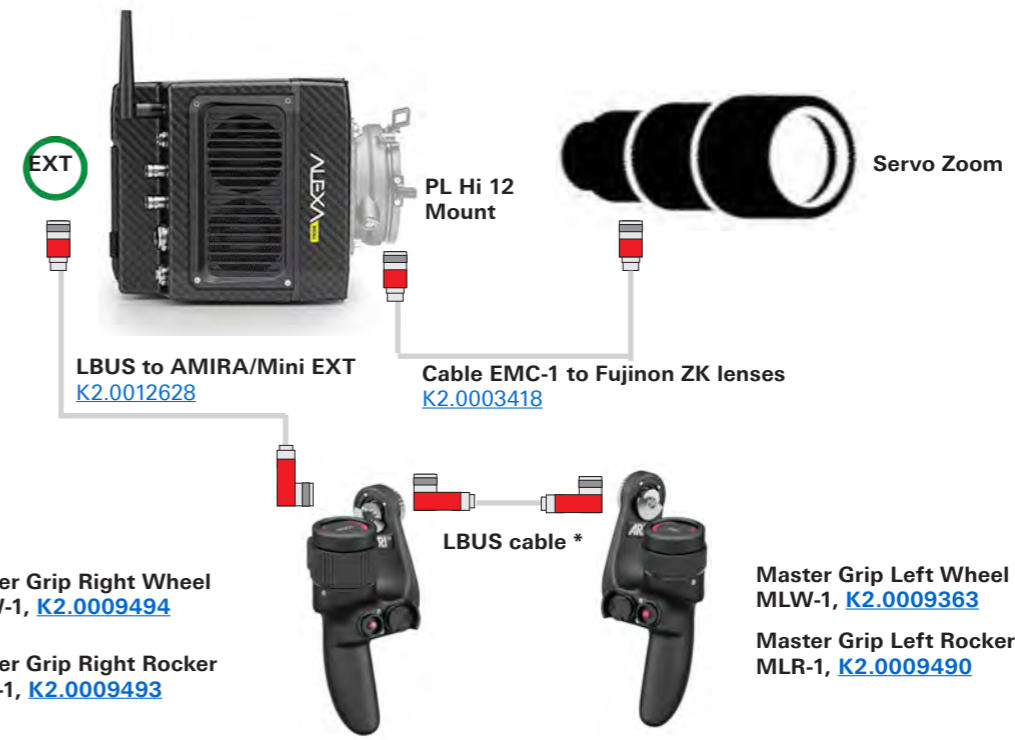

ALEXA Mini - EF Lens

EF lens control requires at least AMIRA/ALEXA Mini SUP 5.0

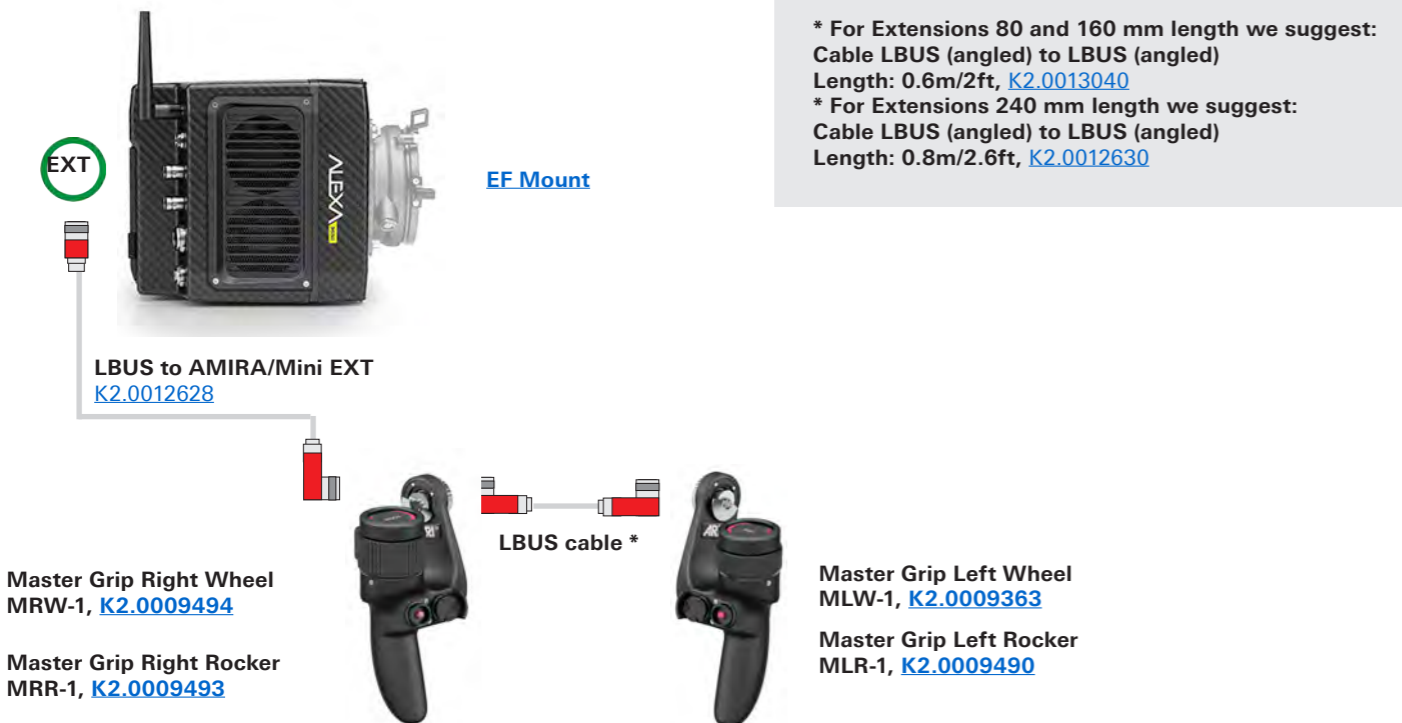

LBUS Cables



LBUS cables need to be ordered separately

- Cable LBUS (straight) to LBUS (straight) Length: 0.2m/8", [K2.0006749](#)
- Cable LBUS (straight) to LBUS (straight) Length: 0.3m/1ft, [K2.0006750](#)
- Cable LBUS (straight) to LBUS (straight) Length: 0.5m/1.5ft, [K2.0006751](#)
- Cable LBUS (straight) to LBUS (straight) Length: 0.8m/2.5ft, [K2.0006752](#)
- Cable LBUS (straight) to LBUS (straight) Length: 1.5m/5ft, [K2.0006753](#)
- Cable LBUS (straight) to LBUS (straight) Length: 3m/10ft, [K2.0006754](#)
- Cable LBUS (straight) to LBUS (straight) Length: 6m/20ft, [K2.0006755](#)
- Cable LBUS (straight) to LBUS (straight) Length: 15m/49ft, [K2.0006756](#)
- Cable LCS (5p) - LBUS (0.8m/2.6ft): [K2.0007318](#)

- Cable LBUS (angled) to LBUS (straight) Length: 0.35m/1.1ft, [K2.0013042](#)
- Cable LBUS (angled) to LBUS (straight) Length: 0.80m/2.3ft, [K2.0013043](#)
- Cable LBUS (angled) to LBUS (straight) Length: 1m/3.3ft, [K2.0013041](#)
- Cable LBUS (angled) to LBUS (straight) Length: 0.3m/1", [K2.0051681](#)
- Cable LBUS (angled) to LBUS (angled) Length: 0.2m/8", [K2.0012785](#)
- Cable LBUS (angled) to LBUS (angled) Length: 0.6m/2ft, [K2.0013040](#)
- Cable LBUS (angled) to LBUS (angled) Length: 0.8m/2.6ft, [K2.0012630](#)

Cable LBUS Star (0.2m/8in). [K2.0023823](#)

Standard Grips & Extensions



Operator Control Unit - Sample Configurations ALEXA Mini LF / ALEXA Mini



Configuration Overview | 4.4.0 / 2026.04

ALEXA Mini LF / ALEXA Mini - Cine Style Lens

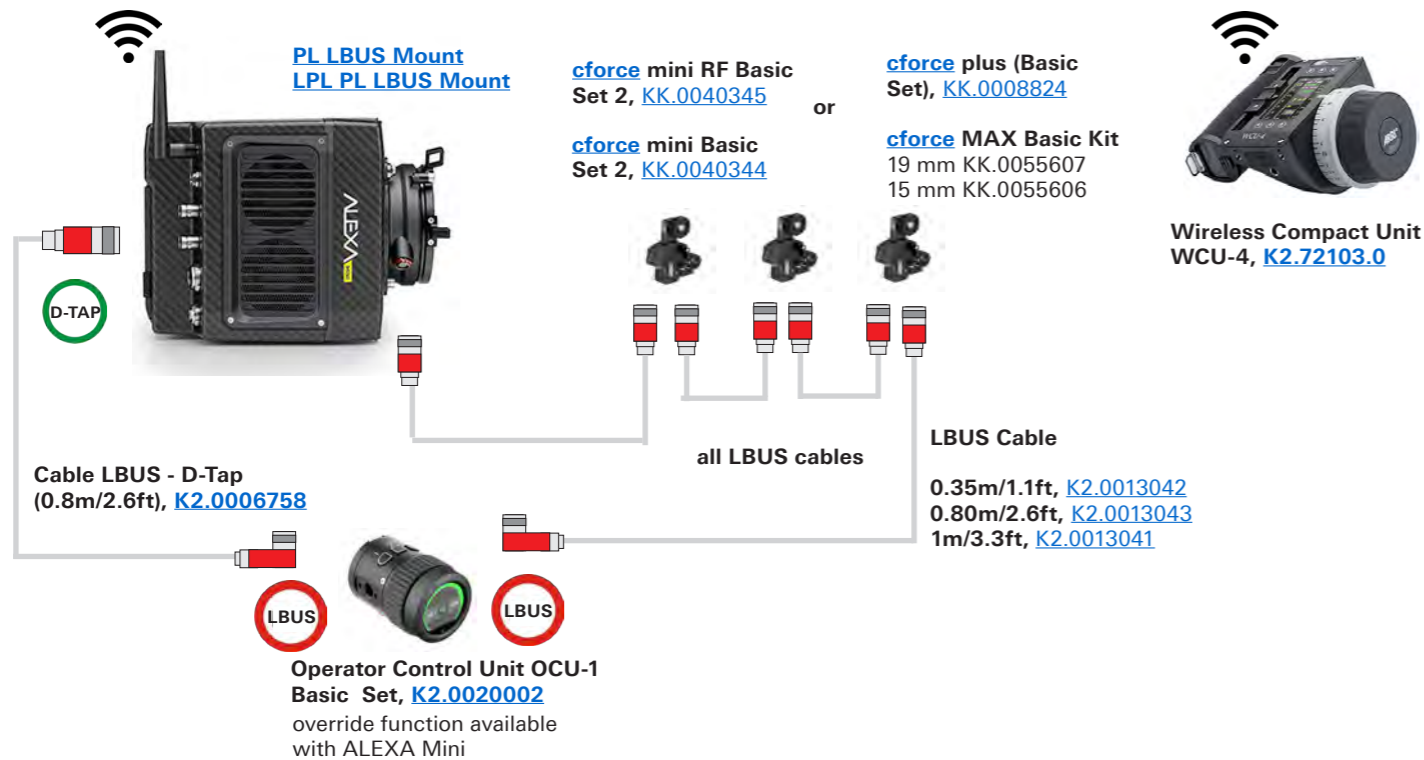

ALEXA Mini LF / ALEXA Mini - Servo Zoom Lens

Servo zoom control requires AMIRA/ALEXA Mini SUP 5.0

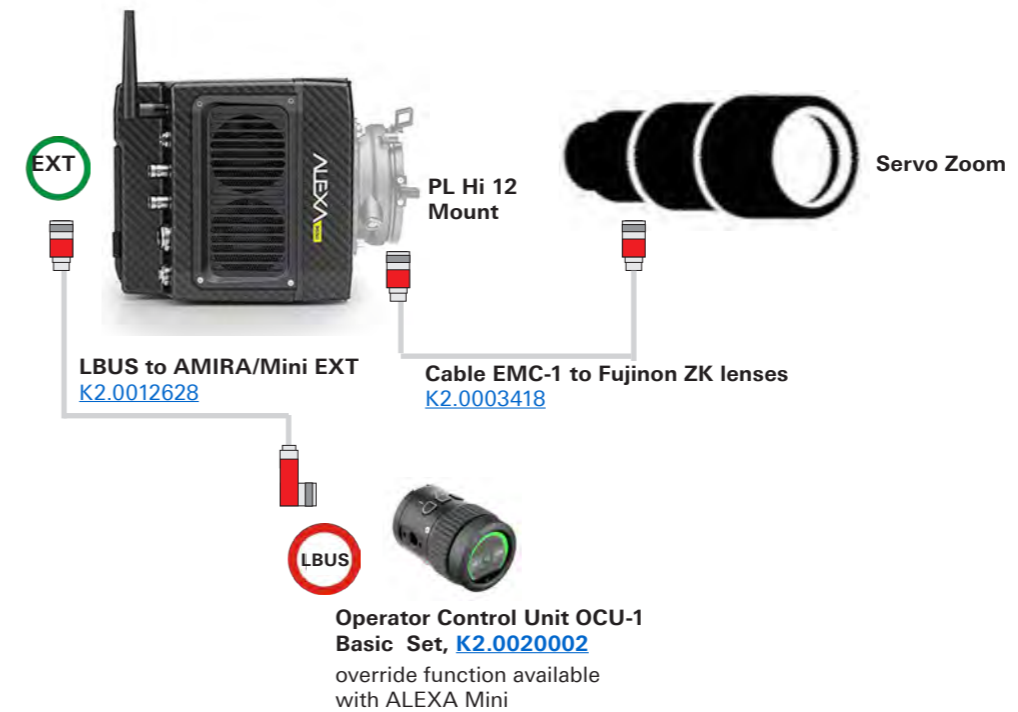

ALEXA Mini LF / ALEXA Mini - EF Lens

EF lens control requires AMIRA/ALEXA Mini SUP 5.0

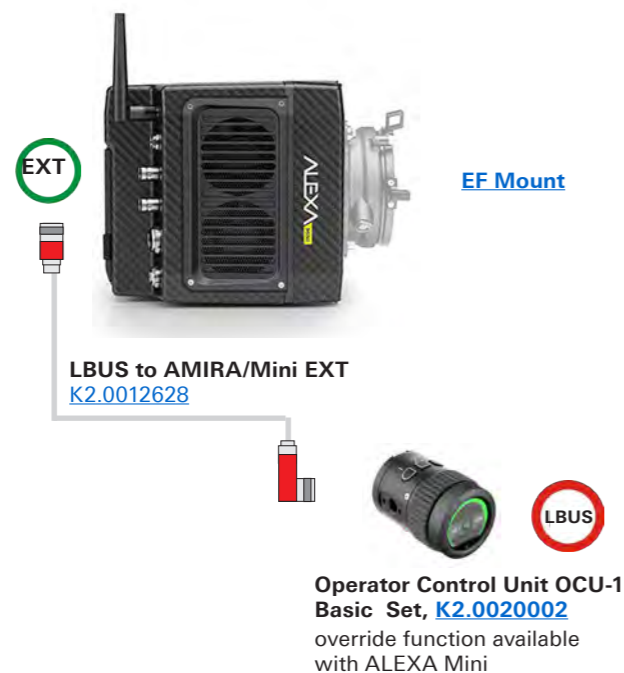

LBUS Cables

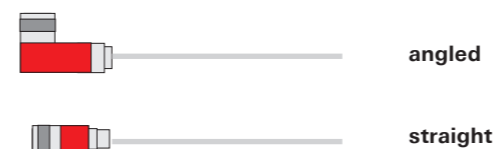

LBUS cables need to be ordered separately

Cable LBUS (straight) to LBUS (straight) Length: 0.2m/8", [K2.0006749](#)
 Cable LBUS (straight) to LBUS (straight) Length: 0.3m/1ft, [K2.0006750](#)
 Cable LBUS (straight) to LBUS (straight) Length: 0.5m/1.5ft, [K2.0006751](#)
 Cable LBUS (straight) to LBUS (straight) Length: 0.8m/2.5ft, [K2.0006752](#)
 Cable LBUS (straight) to LBUS (straight) Length: 1.5m/5ft, [K2.0006753](#)
 Cable LBUS (straight) to LBUS (straight) Length: 3m/10ft, [K2.0006754](#)
 Cable LBUS (straight) to LBUS (straight) Length: 6m/20ft, [K2.0006755](#)
 Cable LBUS (straight) to LBUS (straight) Length: 15m/49ft, [K2.0006756](#)
 Cable LCS (5p) - LBUS (0.8m/2.6ft): [K2.0007318](#)

Cable LBUS (angled) to LBUS (straight) Length: 0.35m/1.1ft, [K2.0013042](#)
 Cable LBUS (angled) to LBUS (straight) Length: 0.80m/2.3ft, [K2.0013043](#)
 Cable LBUS (angled) to LBUS (straight) Length: 1m/3.3ft, [K2.0013041](#)
 Cable LBUS (angled) to LBUS (straight) Length: 0.3m/1", [K2.0051681](#)
 Cable LBUS (angled) to LBUS (angled) Length: 0.2m/8", [K2.0012785](#)
 Cable LBUS (angled) to LBUS (angled) Length: 0.6m/2ft, [K2.0013040](#)
 Cable LBUS (angled) to LBUS (angled) Length: 0.8m/2.6ft, [K2.0012630](#)

Cable LBUS Star (0.2m/8in). [K2.0023823](#)

Accessories



Operator Control Unit - Sample Configurations ALEXA Mini LF / ALEXA Mini



Configuration Overview | 4.4.1 / 2026.04

ALEXA Plus / Studio - Cine Style Lens



ALEXA LF - Cine Style Lens

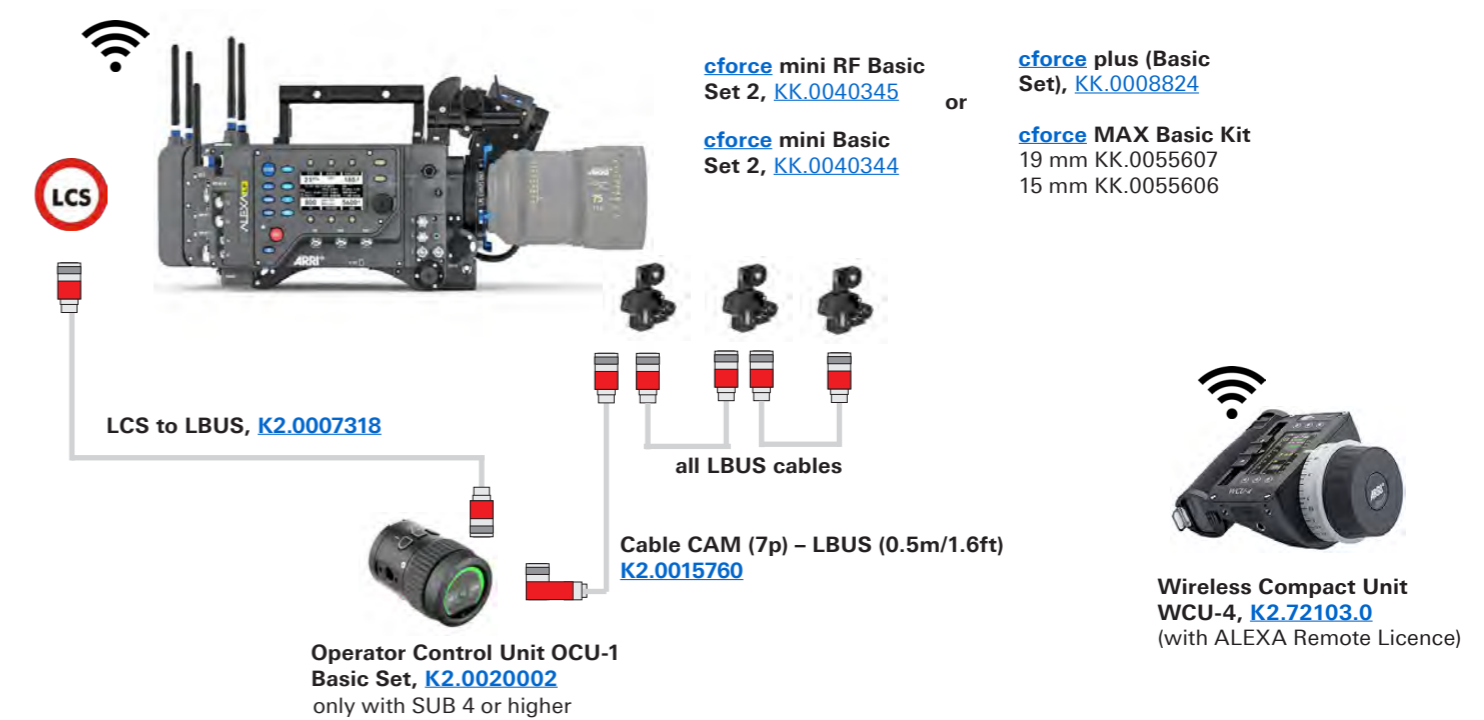

LBUS Cables

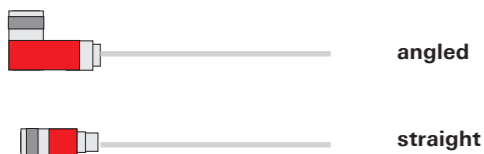

LBUS cables need to be ordered separately

- Cable LBUS (straight) to LBUS (straight) Length: 0.2m/8", [K2.0006749](#)
- Cable LBUS (straight) to LBUS (straight) Length: 0.3m/1ft, [K2.0006750](#)
- Cable LBUS (straight) to LBUS (straight) Length: 0.5m/1.5ft, [K2.0006751](#)
- Cable LBUS (straight) to LBUS (straight) Length: 0.8m/2.5ft, [K2.0006752](#)
- Cable LBUS (straight) to LBUS (straight) Length: 1.5m/5ft, [K2.0006753](#)
- Cable LBUS (straight) to LBUS (straight) Length: 3m/10ft, [K2.0006754](#)
- Cable LBUS (straight) to LBUS (straight) Length: 6m/20ft, [K2.0006755](#)
- Cable LBUS (straight) to LBUS (straight) Length: 15m/49ft, [K2.0006756](#)
- Cable LCS (5p) - LBUS (0.8m/2.6ft): [K2.0007318](#)

- Cable LBUS (angled) to LBUS (straight) Length: 0.35m/1.1ft, [K2.0013042](#)
- Cable LBUS (angled) to LBUS (straight) Length: 0.80m/2.3ft, [K2.0013043](#)
- Cable LBUS (angled) to LBUS (straight) Length: 1m/3.3ft, [K2.0013041](#)
- Cable LBUS (angled) to LBUS (straight) Length: 0.3m/1", [K2.0051681](#)
- Cable LBUS (angled) to LBUS (angled) Length: 0.2m/8", [K2.0012785](#)
- Cable LBUS (angled) to LBUS (angled) Length: 0.6m/2ft, [K2.0013040](#)
- Cable LBUS (angled) to LBUS (angled) Length: 0.8m/2.6ft, [K2.0012630](#)

Cable LBUS Star (0.2m/8in). [K2.0023823](#)

Accessories



ALEXA EV - Cine Style Lens

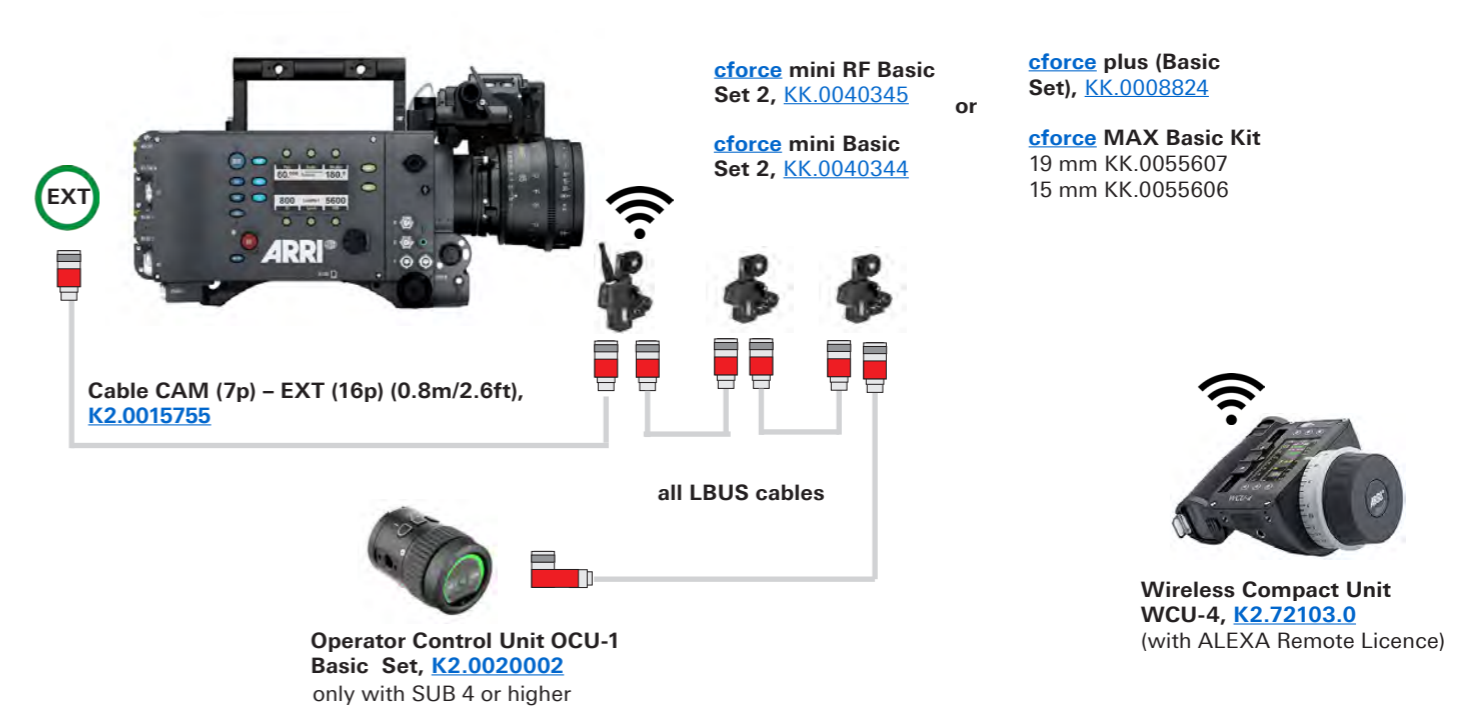

Operator Control Unit - Sample Configurations AMIRA



Configuration Overview | 4.4.2 / 2026.04

AMIRA - Cine Style Lens

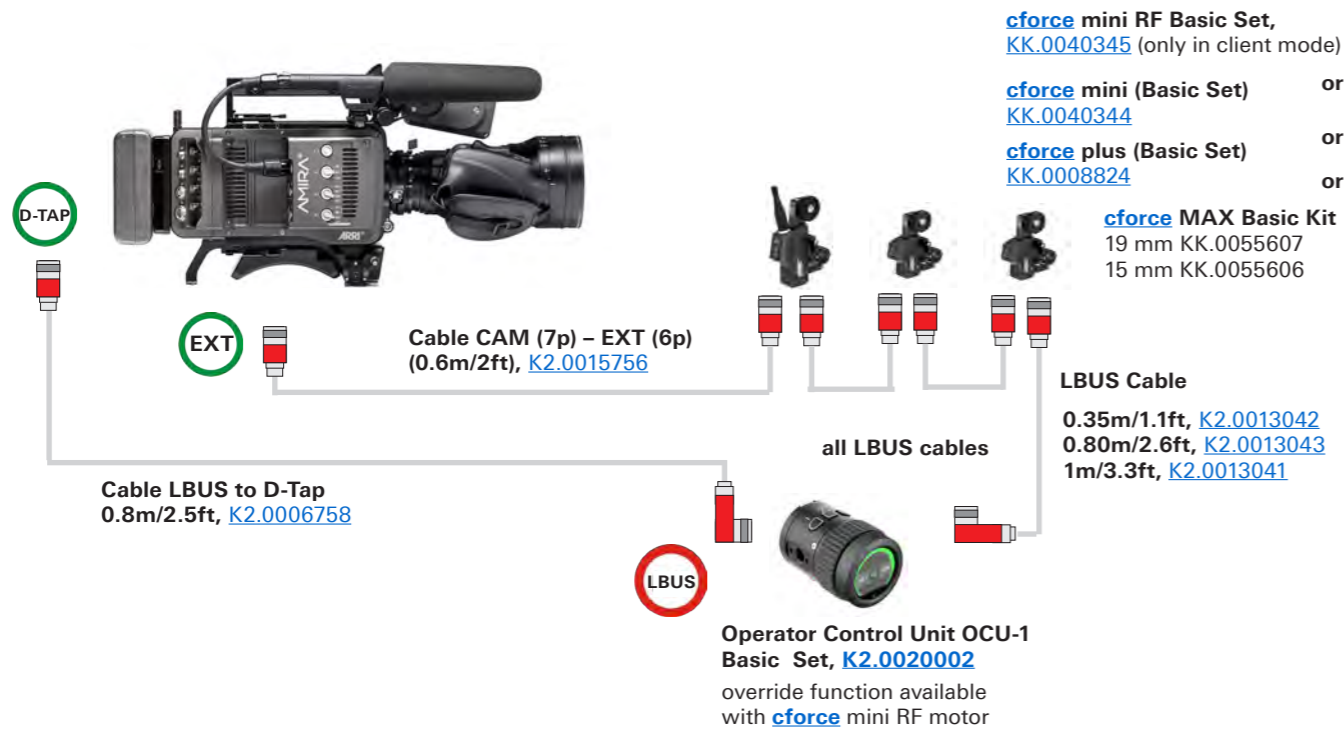

AMIRA - Servo Zoom Lens

Servo zoom control requires AMIRA/ALEXA Mini SUP 5.0 or higher

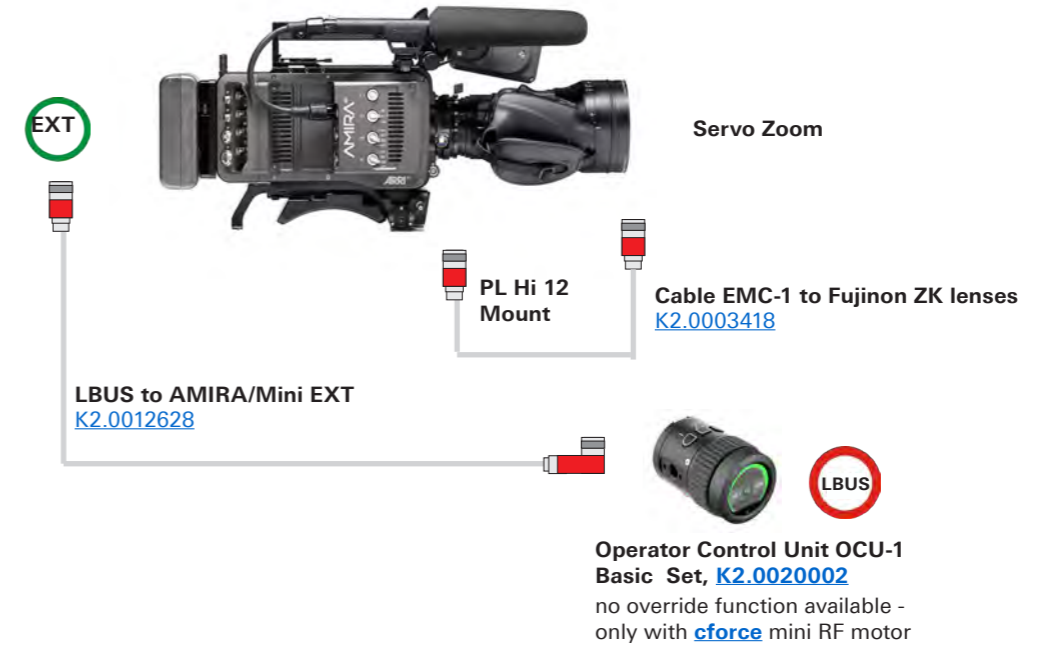

AMIRA - EF Lens

EF lens control requires AMIRA/ALEXA Mini SUP 5.0 or higher



* For Extensions 80 and 160 mm length we suggest:
Cable LBUS (angled) to LBUS (angled)
Length: 0.6m/2ft, [K2.0013040](#)
* For Extensions 240 mm length we suggest:
Cable LBUS (angled) to LBUS (angled)
Length: 0.8m/2.6ft, [K2.0012630](#)

LBUS Cables

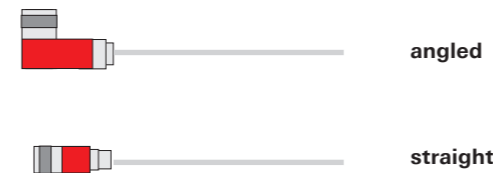

LBUS cables need to be ordered separately

- Cable LBUS (straight) to LBUS (straight) Length: 0.2m/8", [K2.0006749](#)
- Cable LBUS (straight) to LBUS (straight) Length: 0.3m/1ft, [K2.0006750](#)
- Cable LBUS (straight) to LBUS (straight) Length: 0.5m/1.5ft, [K2.0006751](#)
- Cable LBUS (straight) to LBUS (straight) Length: 0.8m/2.5ft, [K2.0006752](#)
- Cable LBUS (straight) to LBUS (straight) Length: 1.5m/5ft, [K2.0006753](#)
- Cable LBUS (straight) to LBUS (straight) Length: 3m/10ft, [K2.0006754](#)
- Cable LBUS (straight) to LBUS (straight) Length: 6m/20ft, [K2.0006755](#)
- Cable LBUS (straight) to LBUS (straight) Length: 15m/49ft, [K2.0006756](#)
- Cable LCS (5p) - LBUS (0.8m/2.6ft): [K2.0007318](#)
- Cable LBUS (angled) to LBUS (straight) Length: 0.35m/1.1ft, [K2.0013042](#)
- Cable LBUS (angled) to LBUS (straight) Length: 0.80m/2.3ft, [K2.0013043](#)
- Cable LBUS (angled) to LBUS (straight) Length: 1m/3.3ft, [K2.0013041](#)
- Cable LBUS (angled) to LBUS (straight) Length: 0.3m/1", [K2.0051681](#)
- Cable LBUS (angled) to LBUS (angled) Length: 0.2m/8", [K2.0012785](#)
- Cable LBUS (angled) to LBUS (angled) Length: 0.6m/2ft, [K2.0013040](#)
- Cable LBUS (angled) to LBUS (angled) Length: 0.8m/2.6ft, [K2.0012630](#)

Cable LBUS Star (0.2m/8in). [K2.0023823](#)

Accessories



Operator Control Unit - Sample Configurations 3rd Party Camera



Configuration Overview | 4.4.3 / 2026.04

3rd Party Camera - Cine Lens

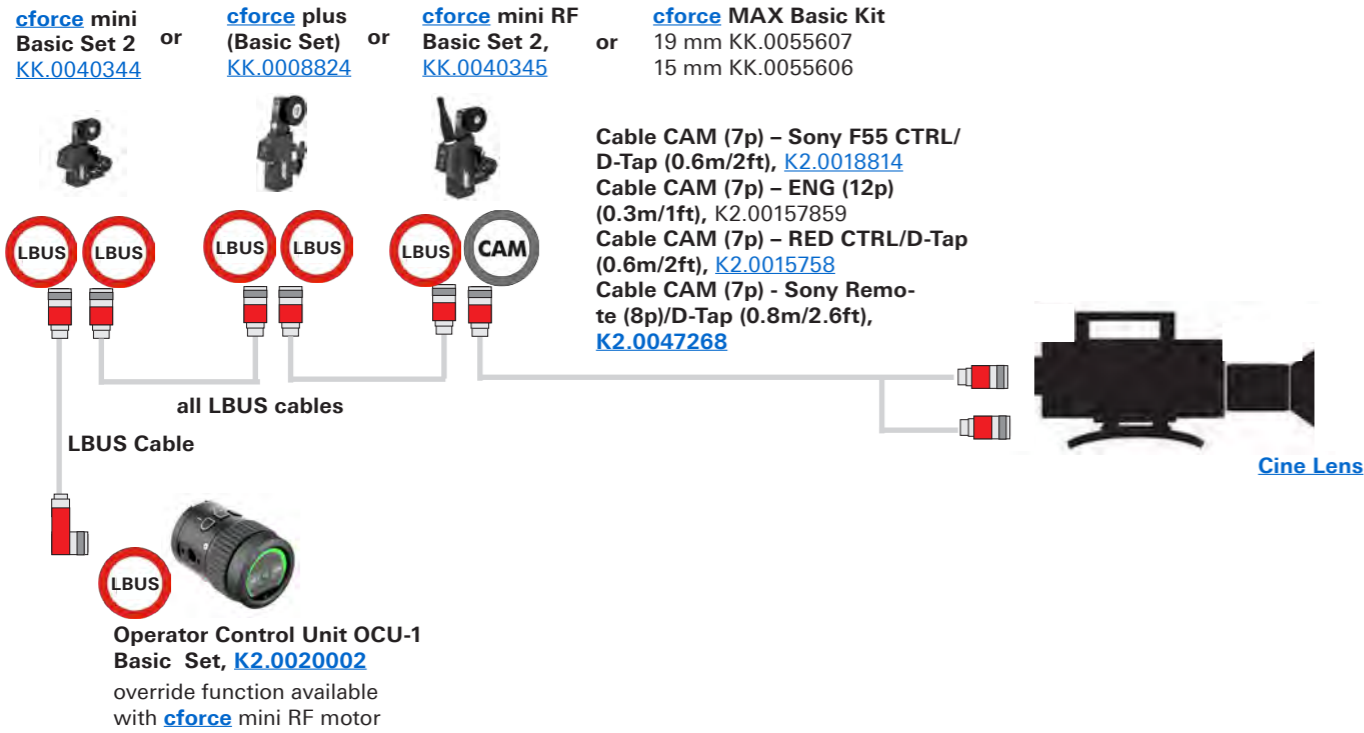

3rd Party Camera - Cine Lens



LBUS Cables

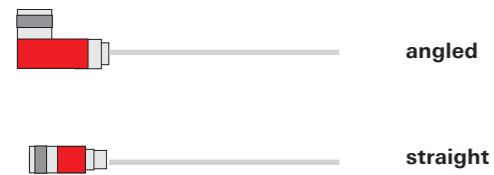

LBUS cables need to be ordered separately

Cable LBUS (straight) to LBUS (straight) Length: 0.2m/8", [K2.0006749](#)
 Cable LBUS (straight) to LBUS (straight) Length: 0.3m/1ft, [K2.0006750](#)
 Cable LBUS (straight) to LBUS (straight) Length: 0.5m/1.5ft, [K2.0006751](#)
 Cable LBUS (straight) to LBUS (straight) Length: 0.8m/2.5ft, [K2.0006752](#)
 Cable LBUS (straight) to LBUS (straight) Length: 1.5m/5ft, [K2.0006753](#)
 Cable LBUS (straight) to LBUS (straight) Length: 3m/10ft, [K2.0006754](#)
 Cable LBUS (straight) to LBUS (straight) Length: 6m/20ft, [K2.0006755](#)
 Cable LBUS (straight) to LBUS (straight) Length: 15m/49ft, [K2.0006756](#)
 Cable LCS (5p) - LBUS (0.8m/2.6ft): [K2.0007318](#)

Cable LBUS (angled) to LBUS (straight) Length: 0.35m/1.1ft, [K2.0013042](#)
 Cable LBUS (angled) to LBUS (straight) Length: 0.80m/2.3ft, [K2.0013043](#)
 Cable LBUS (angled) to LBUS (straight) Length: 1m/3.3ft, [K2.0013041](#)
 Cable LBUS (angled) to LBUS (straight) Length: 0.3m/1", [K2.0051681](#)
 Cable LBUS (angled) to LBUS (straight) Length: 0.2m/8", [K2.0012785](#)
 Cable LBUS (angled) to LBUS (angled) Length: 0.6m/2ft, [K2.0013040](#)
 Cable LBUS (angled) to LBUS (angled) Length: 0.8m/2.6ft, [K2.0012630](#)

Cable LBUS Star (0.2m/8in). [K2.0023823](#)

Accessories

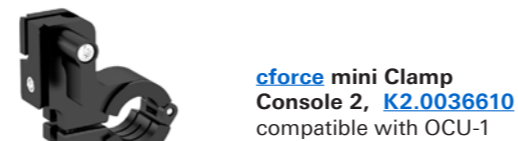

3rd Party Camera - Servo Zoom Lens

Servo zoom control requires AMIRA/ALEXA Mini SUP 5.0 and higher

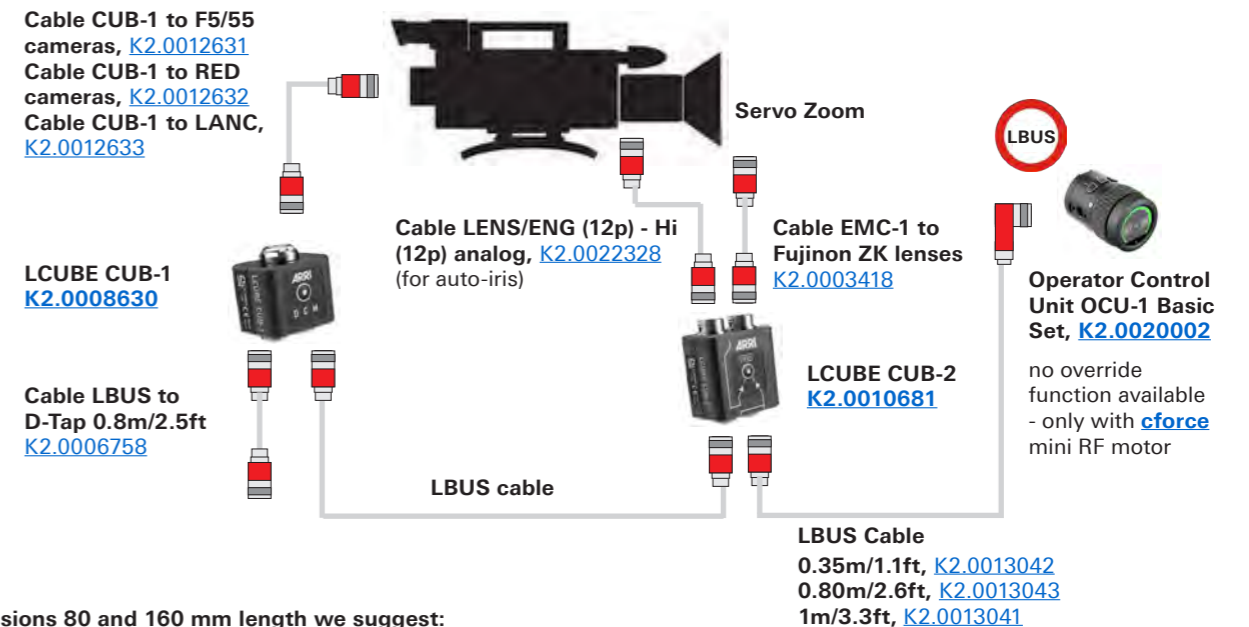

* For Extensions 80 and 160 mm length we suggest:
 Cable LBUS (angled) to LBUS (angled) Length: 0.6m/2ft, [K2.0013040](#)
 * For Extensions 240 mm length we suggest:
 Cable LBUS (angled) to LBUS (angled) Length: 0.8m/2.6ft, [K2.0012630](#)

cforce mini RF - Sample Configuration



Configuration Overview | 4.5.0 / 2026.04

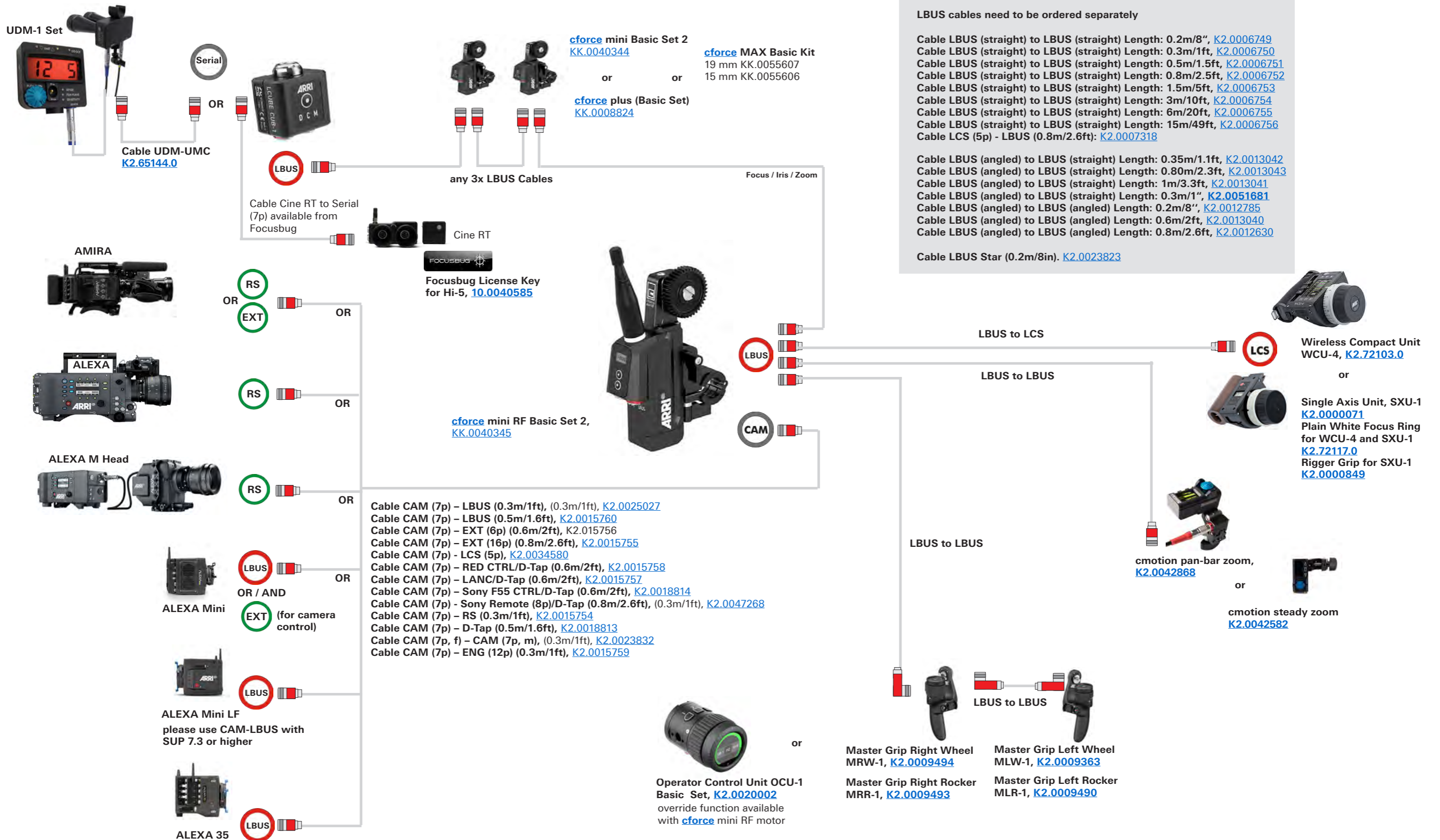

cforce mini RF - Cable Guide



Configuration Overview | 4.5.1 / 2025.10

Item Number	Cable Name	Supported Cameras	Camera Control		
			Run/Stop?	on Hi-5	on WCU-4
K2.0025027	Cable CAM (7p) – LBUS (0.3m/1ft)	ALEXA 35, or when using a cforce mini RF motor in CLIENT mode in a daisy chain with other cforce motors.	Yes	Yes	Yes
K2.0015760	Cable CAM (7p) – LBUS (0.5m/1.6ft)	ALEXA 35, or when using a cforce mini RF motor in CLIENT mode in a daisy chain with other cforce motors.	Yes	Yes	Yes
K2.0015756	Cable CAM (7p) – EXT (6p) (0.6m/2ft)	ALEXA Mini, ALEXA Mini LF, AMIRA	Yes	Yes	Yes
K2.0015755	Cable CAM (7p) – EXT (16p) (0.8m/2.6ft)	ALEXA Classic EV, ALEXA XT EV, ALEXA SXT EV. Only works with ALEXA EV cameras, not ALEXA Plus	Yes	Yes	Yes
K2.0034580	Cable CAM (7p) - LCS (5p) (0.8m/2.6ft)	ALEXA Plus cameras including ALEXA Plus, ALEXA XT Plus, ALEXA SXT Plus, ALEXA LF, ALEXA 65	Yes	Yes	Yes
K2.0015758	Cable CAM (7p) – RED CTRL/D-Tap (0.6m/2ft)	RED DSMC2 cameras except those with Base Expander Module. RED DSMC3 cameras (Komodo/V-Raptor) with module or break-out cable from 9p Lemo EXT Connector to RED CTRL connector. Supports run/stop/tally on WCU-4 and Hi-5. Additional RED Camera Control License Key required for further camera control on Hi-5	Yes	Yes	No
K2.0015757	Cable CAM (7p) – LANC/D-Tap (0.6m/2ft)	Many cameras with a LANC connector including Canon C300/C500 series, Sony PXW-FX9/FS7 and Blackmagic Ursa Mini Pro	Yes	No	No
K2.0018814	Cable CAM (7p) – Sony Venice/F55 CTRL/D-Tap (0.6m/2ft)	Sony F5/F55 and Sony Venice. Not compatible with Sony Venice 2, Panasonic Varicam, Panasonic Vari-cam LT	Yes	No	No
K2.0047268	Cable CAM (7p) - Sony Remote (8p)/D-Tap (0.8m/2.6ft)	Run/stop/tally for Sony Venice and Venice 2. Additional camera control supported on Hi-5 with Sony Camera Control License Key for Hi-5	Yes	Yes	No
K2.0015754	Cable CAM (7p) – RS (0.3m/1ft)	Run/stop/tally on all ARRI Cameras and any camera that supports run/stop via a 3p Fischer connector. Can also be used to supply additional power to an LBUS chain	Yes	No	No
K2.0018813	Cable CAM (7p) – D-Tap (0.5m/1.6ft)	For adding additional power into an LBUS system, or for powering the cforce mini RF without any camera connection	No	No	No
K2.0023832	Cable CAM (7p, f) – CAM (7p, m) (0.3m/1ft)	Extension cable for any CAM cable	N/A	N/A	N/A
K2.0015759	Cable CAM (7p) – ENG (12p) (0.3m/1ft)	Broadcast cameras that feature a 12p Hirose Lens connector. Required for remote iris control by Sony or Skaarhoj RCP. Can also be used to inject lens metadata into Sony Venice LENS connector.	N/A	N/A	N/A

Note: Sony and RED Camera Control Licenses required for camera control on Hi-5. ALEXA Remote License Key required for ALEXA/AMIRA camera control on WCU-4.

cforce mini



cforce mini Basic Set 2
KK.0040344

LBUS **LBUS**



cforce mini Motor Unit
K2.0006354



cforce mini Clamp Console 2
19/15mm, K2.0036610



CLM-5/cforce mini Gear
m0.8/32p, 40t, K2.0003753

cforce plus



cforce plus (Basic Set)
KK.0008824

LBUS **LBUS**



cforce plus Motor Unit, K2.0008819



cforce plus Clamp Console
19/15 mm, K2.0008678



cforce plus Gear m0.8/32p, 60t,
K2.0009335

cforce MAX



cforce MAX Basic Kit
19 mm KK.0055607
15 mm KK.0055606

LBUS **LBUS**



cforce MAX Motor Unit, K2.0055211



Motor Rod Clamp MRC-1
19 mm K2.0053386
15 mm K2.0055222



CLM-4/cforce Gear
m0.8/32p, 50t, K2.72108.0

cforce mini RF



cforce mini RF Basic Set 2,
KK.0040345

LBUS **CAM**



cforce mini RF Motor Unit
K2.0016802



cforce mini Clamp Console 2 19/15mm,
K2.0036610



CLM-5/cforce mini Gear m0.8/32p, 40t,
K2.0003753



Outdoor Antenna, straight, for UMC-4 Motor Controller,
K2.0002007

cforce mini / MAX & CLM-5 Accessories



CLM-5/cforce mini Clamp Console 19/15mm,
K2.0006176



CLM-5/cforce mini Clamp Insert 19/15mm (incl. in
K2.0006176) K2.0006175



cforce mini Clamp Console 2 19/15mm
K2.0036610



Motor Rod Clamp MRC-1
19 mm K2.0053386
15 mm K2.0055222



cforce mini Clamp Insert 2 15mm
K2.0038503



cforce mini Clamp Insert 2 5/8in
K2.0038504



CLM-5/cforce mini Gear m0.8/32p, 40t, K2.0003753
CLM-5/cforce mini Gear m0.8, 40t, 25 mm, K2.0006372
CLM-5/cforce mini Gear m0.4/64p, 80t, K2.0006367
CLM-5/cforce mini Gear m0.5, 64t, K2.0006365
CLM-5/cforce mini Gear m0.6, 56t, K2.0006363
CLM-5/cforce mini Gear 48p, 60t, K2.0006370

CLM-4/cforce Gear m0.8/32p, 50t, K2.72108.0
CLM-4/cforce Gear m0.8, 50t, 25mm, K2.72112.0

cforce plus / MAX & CLM-4 Accessories



CLM-4 Rod-to-Rod Adapter 15mm, K2.72106.0



CLM-4 Rod-to-Rod Bridge Adapter 15mm, K2.72107.0



Motor Rod Clamp MRC-1
19 mm K2.0053386
15 mm K2.0055222



CLM-4 Rosette Adapter for Hill Bracket, K2.72113.0



Gear Screw for CLM-4
K2.72127.0



CLM-4/cforce plus Gear assembly with modul 0.6, 70 teeth, K2.72111.0

CLM-4/cforce plus Gear assembly with 48 pitch, 75 teeth, K2.0002044

CLM-4/cforce plus Gear assembly with module 0.5, 80 teeth, K2.72110.0

CLM-4/cforce plus Gear assembly with module 0.4/64 pitch, 100 teeth, K2.72109.0

LBUS / CAM Cables

LBUS cables need to be ordered separately



LBUS (straight) to LBUS (straight) Length: 0.2m/8", K2.0006749
LBUS (straight) to LBUS (straight) Length: 0.3m/1ft, K2.0006750
LBUS (straight) to LBUS (straight) Length: 0.5m/1.5ft, K2.0006751
LBUS (straight) to LBUS (straight) Length: 0.8m/2.5ft, K2.0006752
LBUS (straight) to LBUS (straight) Length: 1.5m/5ft, K2.0006753
LBUS (straight) to LBUS (straight) Length: 3m/10ft, K2.0006754
LBUS (straight) to LBUS (straight) Length: 6m/20ft, K2.0006755
LBUS (straight) to LBUS (straight) Length: 15m/49ft, K2.0006756
LCS (5p) - LBUS (0.8m/2.6ft): K2.0007318

LBUS (angled) to LBUS (straight) Length: 0.35m/1.1ft, K2.0013042
LBUS (angled) to LBUS (straight) Length: 0.80m/2.3ft, K2.0013043
LBUS (angled) to LBUS (straight) Length: 1m/3.3ft, K2.0013041
LBUS (angled) to LBUS (angled) Length: 0.2m/8", K2.0012785
LBUS (angled) to LBUS (angled) Length: 0.6m/2ft, K2.0013040
LBUS (angled) to LBUS (angled) Length: 0.8m/2.6ft, K2.0012630
LBUS Star (0.2m/8in). K2.0023823

Cable CAM (7p) – RS (0.3m/1ft), K2.0015754
Cable CAM (7p) – EXT (16p) (0.8m/2.6ft), K2.0015755
Cable CAM (7p) – EXT (6p) (0.6m/2ft), K2.0015756
Cable CAM (7p) – LANC/D-Tap (0.6m/2ft), K2.0015757
Cable CAM (7p) – RED CTRL/D-Tap (0.6m/2ft), K2.0015758
Cable CAM (7p) – ENG (12p) (0.3m/1ft), K2.0015759
Cable CAM (7p) – LBUS (0.5m/1.6ft), K2.0015760
Cable CAM (7p) – Sony F55 CTRL/D-Tap (0.6m/2ft), K2.0018814
Cable CAM (7p) – D-Tap (0.5m/1.6ft), K2.0018813
Cable CAM (7p, f) – CAM (7p, m), (0.3m/1ft), K2.0023832
Cable CAM (7p) – LBUS (0.3m/1ft), (0.3m/1ft), K2.0025027

Lens Type	Focus Gear	Iris Gear	Zoom Gear
CINE	Module 0.8 / 32 pitch	Module 0.8 / 32 pitch	Module 0.8 / 32 pitch
Panavision	Module 0.8 / 32 pitch	Module 0.4 / 64 pitch	48 pitch (no common pitch equivalent)
Fujifilm B4 ENG	Module 0.6 (no common pitch equivalent)	Module 0.4 / 64 pitch	Modul 0.6 (no common pitch equivalent)
Canon B4 ENG	Module 0.5 (no common pitch equivalent)	Module 0.4 / 64 pitch	Modul 0.5 (no common pitch equivalent)

Configuration Overview | 4.5.3 / 2025.10

CLM-4 & Accessories



Controlled Lens Motor CLM-4 (Set)
[KK.0005855](#)



Cable for CLM-4 Motor, [K2.72099.0](#)



CLM-4 Gear Set
0.8, 0.6, 0.5, 0.4,
[K2.72116.0](#)
(incl. one metal core)



Standard Clamp Console for CLM-4
[K2.72101.0](#)



Standard Clamp Console for CLM-3
[K2.65140.0](#)



Clamp Console-2 for CLM-3
[K2.65141.0](#)



19 mm to 15 mm insert for CLM-4, [K2.0002080](#)



CLM-4 Clamp Insert 5/8"
[K2.72115.0](#)



Gear Flange for CLM-4
[K2.0000244](#)



CLM-4 Gear assembly with modul 0.8/32 pitch, 50 teeth
(incl. metal gear Flange), [K2.72108.0](#)



CLM-4 Gear assembly with modul 0.8/32 pitch, 50 teeth,
25mm extra wide [K2.72112.0](#)

CLM-5 ** & Accessories

**** phase out - sales only as long as stock is available**



CLM-5 Motor Unit**
[K2.0006360](#)



CLM-5/cforce mini Clamp Console 19/15mm,
[K2.0006176](#)



CLM-5/cforce mini Gear m0.8/32p, 40t, [K2.0003753](#)



CLM-5 Motor Cable,
[K2.0006332](#)



CLM-5 (Basic Set)**
[K2.0006361](#)

CLM-5** / cforce mini Accessories

**** phase out - sales only as long as stock is available**



CLM-5/cforce mini Clamp Console 19/15mm,
[K2.0006176](#)



CLM-5/cforce mini Clamp Insert 19/15mm (incl. in
[K2.0006176\) K2.0006175](#)



CLM-5/cforce mini Gear m0.8/32p, 40t, [K2.0003753](#)
CLM-5/cforce mini Gear m0.8, 40t, 25 mm, [K2.0006372](#)
CLM-5/cforce mini Gear m0.4/64p, 80t, [K2.0006367](#)
CLM-5/cforce mini Gear m0.5, 64t, [K2.0006365](#)
CLM-5/cforce mini Gear m0.6, 56t, [K2.0006363](#)
CLM-5/cforce mini Gear 48p, 60t, [K2.0006370](#)

CLM-3** & Accessories

**** phase out - sales only as long as stock is available**



Controlled Lens Motor CLM-3 (Set)** [KK.0005854](#)



CLM-3 Motor Unit**
[K2.65143.0](#)



Cable for CLM-3 Motor, [K2.65145.0](#)



Gear for Cine Lenses Module 0.8, 60 teeth for CLM-3, [K2.65142.0](#)



Standard Clamp Console for CLM-3
[K2.65140.0](#)



Clamp Console-2 for CLM-3
[K2.65141.0](#)



19 mm to 15 mm inserts for CLM-3 (pair),
[K2.0002077](#)



CLM-3 gear module 0.8/32 pitch, 60 teeth, [K2.65142.0](#)



CLM-3 gear module, 0.8/32 pitch, 60 teeth, 25mm extra-wide, [K2.0001256](#)



CLM-3 gear module 0.6, 84 teeth, [K2.0001918](#)



CLM-3 gear module with 48 pitch, 90 teeth, [K2.0002055](#)



CLM-3 gear module 0.5, 96 teeth, [K2.0001914](#)



CLM-3 gear module 0.4/64 pitch, 120 teeth, [K2.0001911](#)

LDE-1 Lens Data Encoder**

**** phase out - sales only as long as stock is available**



Lens Data Encoder LDE-1,** [K2.0002680](#)



LDE-1 Cable
[K2.0003040](#)



LDE-1 Gear m0.8/32p, 60t, [K2.0003036](#)
For standard cine lenses focus/iris/zoom,
Panavision focus only.



LDE-1 Gear m0.4/64p, 120t, [K2.0003050](#)
For Panavision iris, Fujinon ENG iris, Canon
ENG iris.



LDE-1 Gear 48p, 90t, [K2.0003052](#)
For Panavision zoom.

CLM-4 / cforce plus Accessories



cforce plus Rod-to-Rod Adapter 15mm, [K2.72106.0](#)



cforce plus Rod-to-Rod Bridge 15mm, [K2.72107.0](#)



CLM-4 Rosette Adapter for Hill Bracket, [K2.72113.0](#)



CLM-4, cforce plus Gear Screw, [K2.72127.0](#)



CLM-4 Gear assembly with modul 0.6, 70 teeth, [K2.72111.0](#)



CLM-4 Gear assembly with 48 pitch, 75 teeth, [K2.0002044](#)



CLM-4 Gear assembly with module 0.5, 80 teeth, [K2.72110.0](#)



CLM-4 Gear assembly with module 0.4/64 pitch, 100 teeth,
[K2.72109.0](#)

Lens Type	Focus Gear	Iris Gear	Zoom Gear
CINE	Module 0.8 / 32 pitch	Module 0.8 / 32 pitch	Module 0.8 / 32 pitch
Panavision	Module 0.8 / 32 pitch	Module 0.4 / 64 pitch	48 pitch (no common pitch equivalent)
Fujifilm B4 ENG	Module 0.6 (no common pitch equivalent)	Module 0.4 / 64 pitch	Module 0.6 (no common pitch equivalent)
Canon B4 ENG	Module 0.5 (no common pitch equivalent)	Module 0.4 / 64 pitch	Module 0.5 (no common pitch equivalent)

Universal Motor Controller UMC-4



Configuration Overview | 4.6.0 / 2025.10

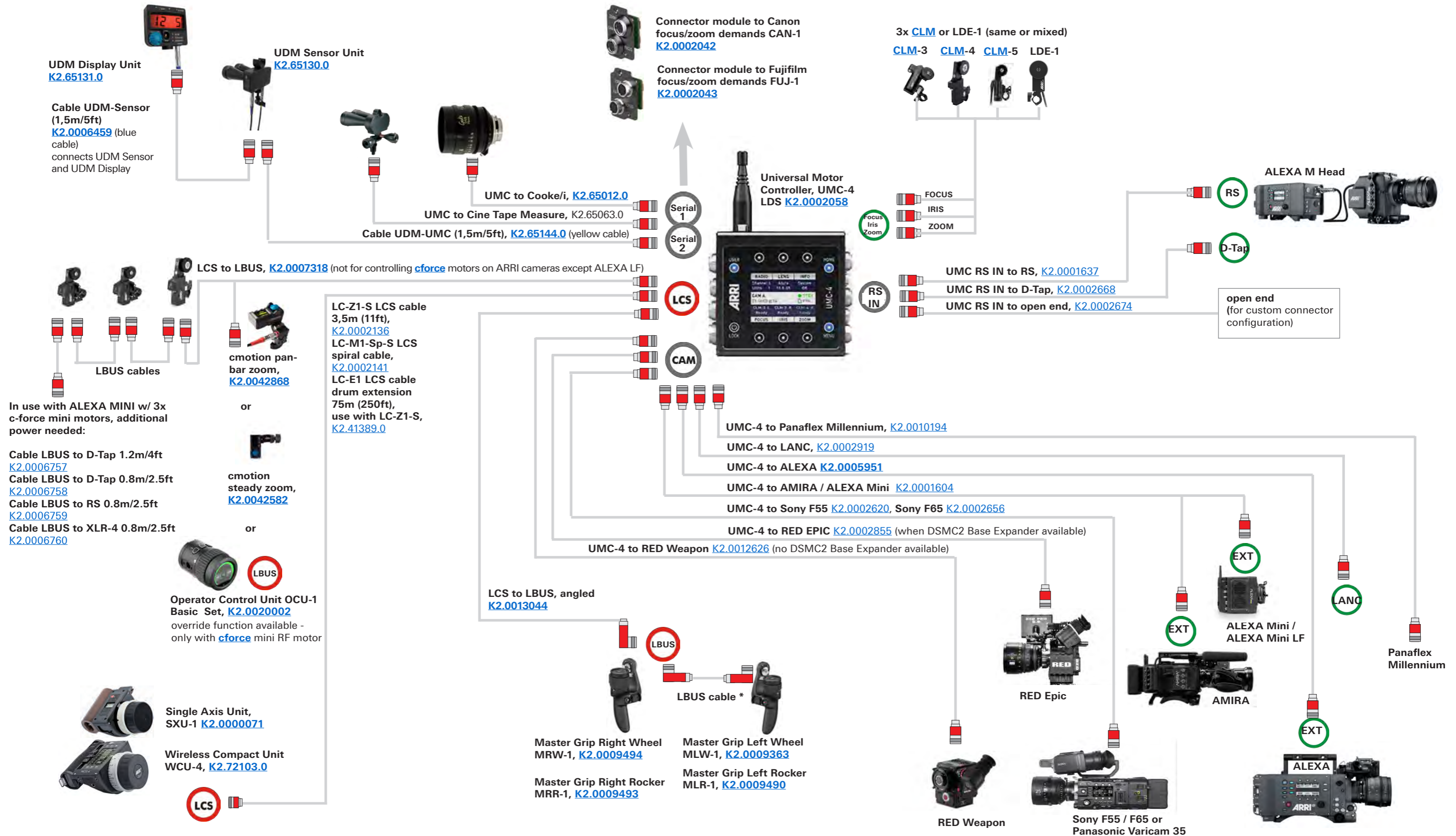

Lens Control System



ERM-2400 Ext 2.4 GHz RXD-TXD Pro Set LCS, [KK.0040048](#)
[K2.0037440](#) 2x ERM-2400,LCS, Single Module
[K2.0033763](#) 2x ERM-2400 Rubber Duck Antenna
[K2.0036900](#) 2x ERM LCS to FS CAN Bus Adapter Cable, 0.2m/0.65ft
[K2.0036903](#) 2x ERM LBUS to FS CAN Bus Adapter Cable, 0.2m/0.65ft
[K2.0036901](#) 1x ERM EXT. to FS CAN Bus Adapter Cable, 0.2m/0.65ft
[K2.0036902](#) 1x ERM D-Tap Pwr Cable, 0B Lemo 2pin to D-Tap, 1m/3.2ft
[K2.0033762](#) 2x SRH FS CAN Bus Cable, 1m/3.2ft

Note:
The basic set is only supplied with adapter cables.

Recommended and required optional extension cables:
 • SRH FS CAN Bus Cable, 10m/32.8ft [K2.0019302](#)
 • SRH FS CAN Bus Cable, 25m/82ft [K2.0019301](#)
 • SRH FS CAN Bus Coupler, 0.2m/0.65ft [K2.0019300](#)



ERM-2400, LCS, Single Spare Module
[K2.0037440](#), incl. Antenna
 coupling through ARRI Service

Stabilized Remote Head



ERM-2400 2.4 GHz RXD-TXD Basic Set, SRH-3, [KK.0040049](#)
 includes:
[K2.0037428](#) 2x ERM-2400, SRH, Single Module
[K2.0033763](#) 2x ERM-2400 Rubber Duck Antenna
[K2.0033762](#) 2x SRH FS CAN Bus Cable, 1m/3.2ft
[K2.0033761](#) 1x ERM Power Cable, ERM-2400 & ERM-900

Range:
Up to 1000 meter / 3280 ft.



ERM-2400, SRH, Single Spare Module
[K2.0037428](#), incl. Antenna



ERM-900 MHz RXD-TXD Basic Set, SRH-3, [KK.0040050](#)
 includes:
[K2.0037425](#) 2x ERM-900, SRH, Single Module
[K2.0033765](#) 2x ERM-900 Rubber Duck Antenna
[K2.0033762](#) 2x SRH FS CAN Bus Cable, 1m/3.2ft
[K2.0033761](#) 1x ERM Power Cable, ERM-2400 & ERM-900

Range:
Up to 3000 meter / 6560 ft



ERM-900, SRH, Single Spare Module
[K2.0037425](#), incl. Antenna

Cables



ERM LCS to FS CAN Bus Adapter Cable 0.2m/0.65ft
[K2.0036900](#)



ERM LBUS to FS CAN Bus Adapter Cable, 0.2m/0.65ft
[K2.0036903](#)



ERM EXT. to FS CAN Bus Adapter Cable, 0.2m/0.65ft
[K2.0036901](#)



ERM D-Tap Pwr Cable, 0B Lemo 2pin to D-Tap, 1m/3.2ft,
[K2.0036902](#)



Required optional extension cables:
 SRH FS CAN Bus Cable, 0,3m/0.98ft, [K2.0037788](#)
 SRH FS CAN Bus Cable, 1m/3.2ft, [K2.0033762](#)
 SRH FS CAN Bus Cable, 5m/16.4ft, [K2.0037701](#)
 SRH FS CAN Bus Cable, 10m/32.8ft, [K2.0019302](#)
 SRH FS CAN Bus Cable, 25m/82ft, [K2.0019301](#)

LCS Configuration Samples

For Configuration Sample with the Lens Control System please also see **Configuration Overview 4.8.1 & 4.8.2**

SRH Configuration Samples

For Configuration Sample with the SRH-360 & SRH-3 System please also see **Configuration Overview 8.4.2 & 8.4.3 & 8.5.1**



ERM-2400 Rubber Duck Antenna, [K2.0033763](#)



ERM-900 Rubber Duck Antenna, [K2.0033765](#)

ERM - External Radio Module - Sample Configurations, Part I



Configuration Overview | 4.7.1 / 2025.10

ALEXA Mini / ALEXA Mini LF with 3 motors

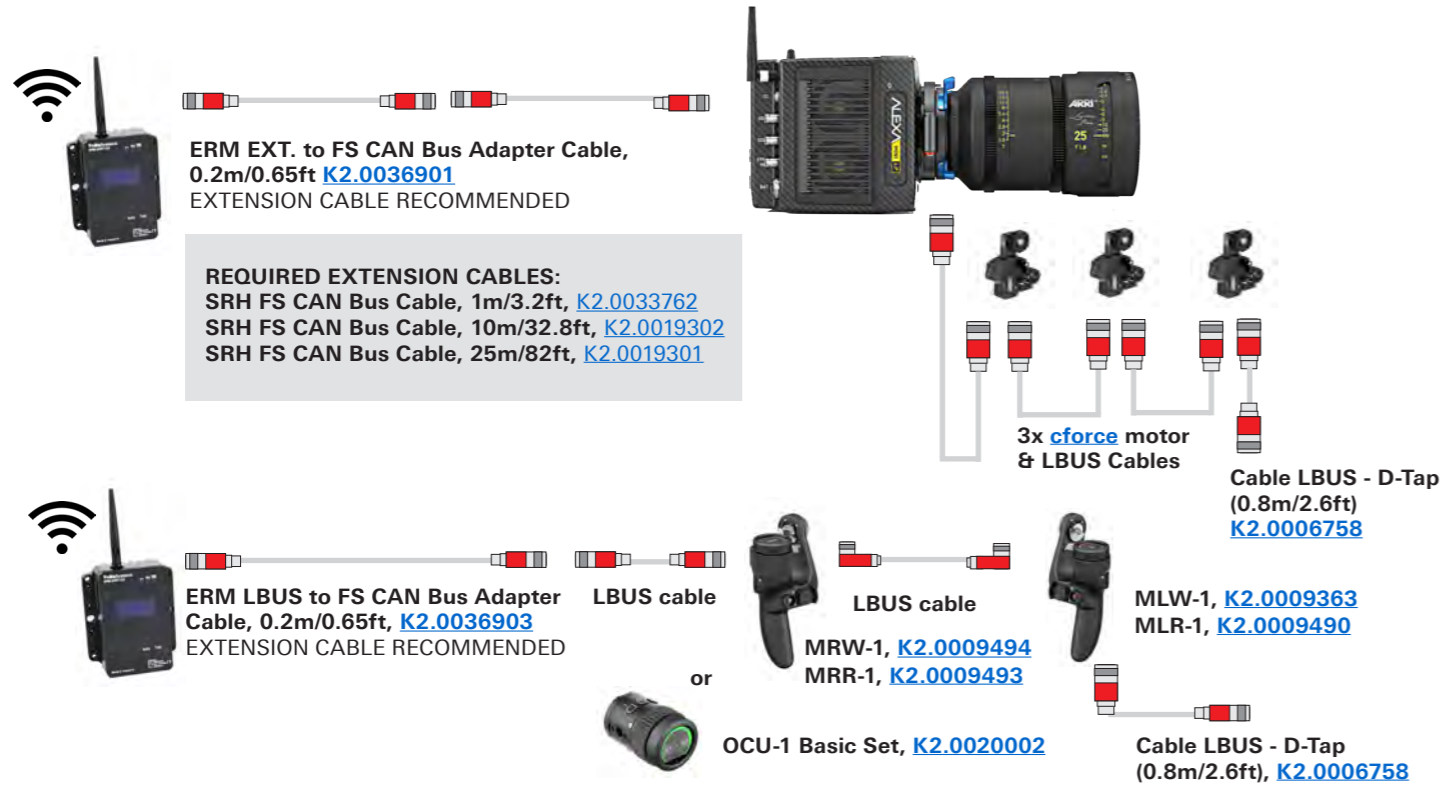

ALEXA Mini / ALEXA Mini LF with 2 motors

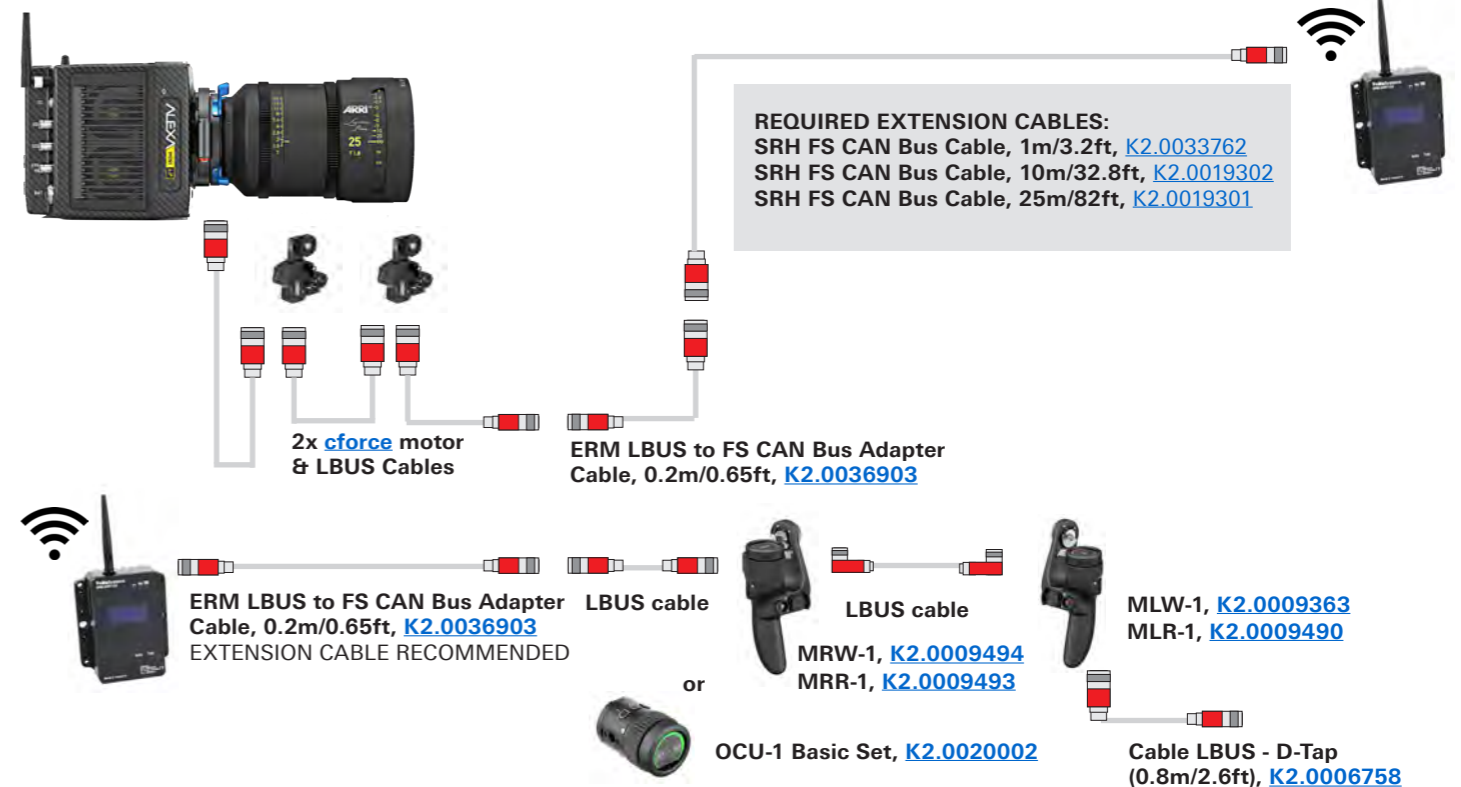

Amira with 3 motors - cforce mini RF and/or cforce mini/plus



Amira with 3 cforce mini motors

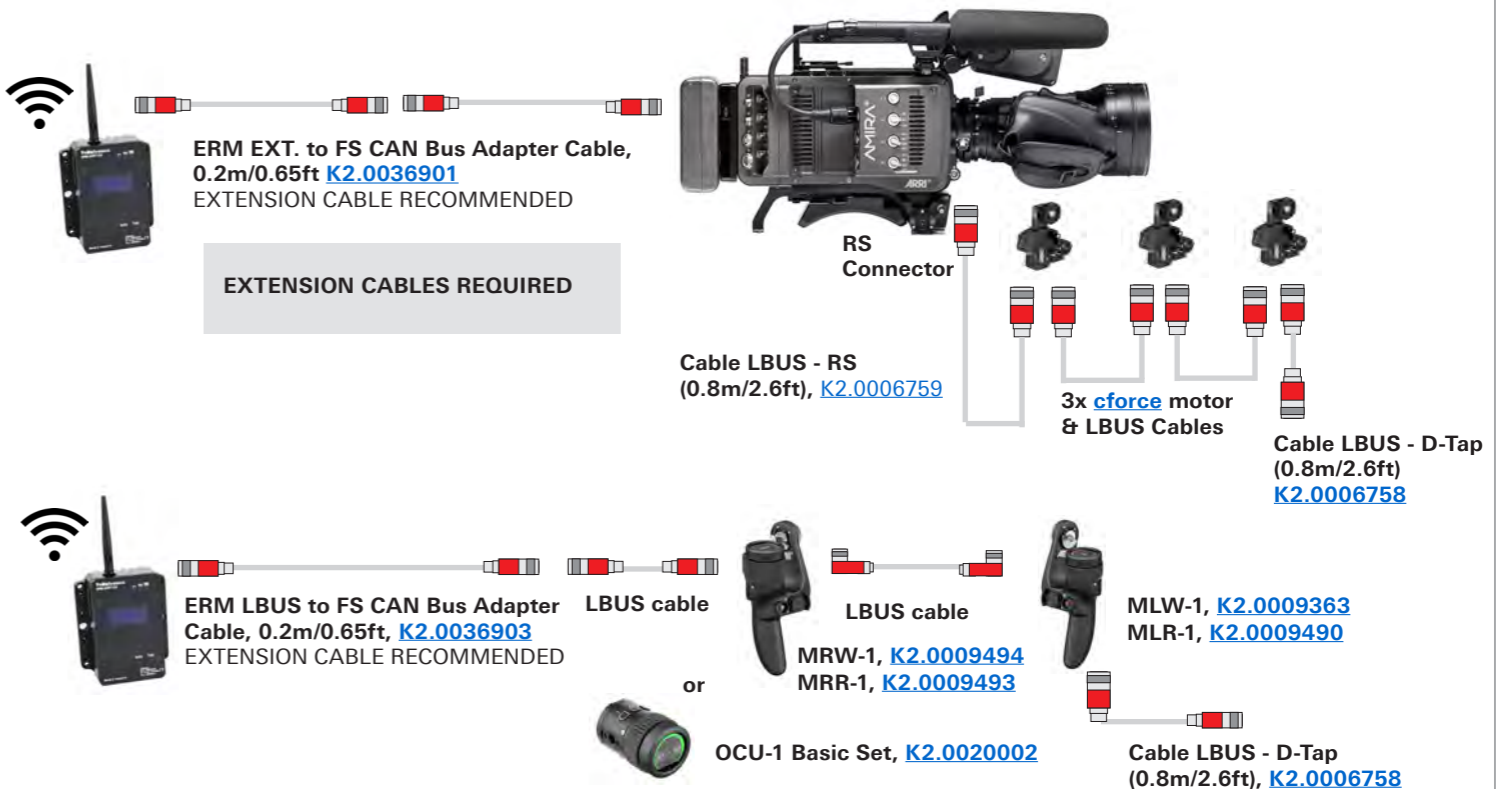

ERM - External Radio Module - Sample Configurations, Part II



Configuration Overview | 4.7.2 / 2025.10

ALEXA Plus / ALEXA LF with CLM motors

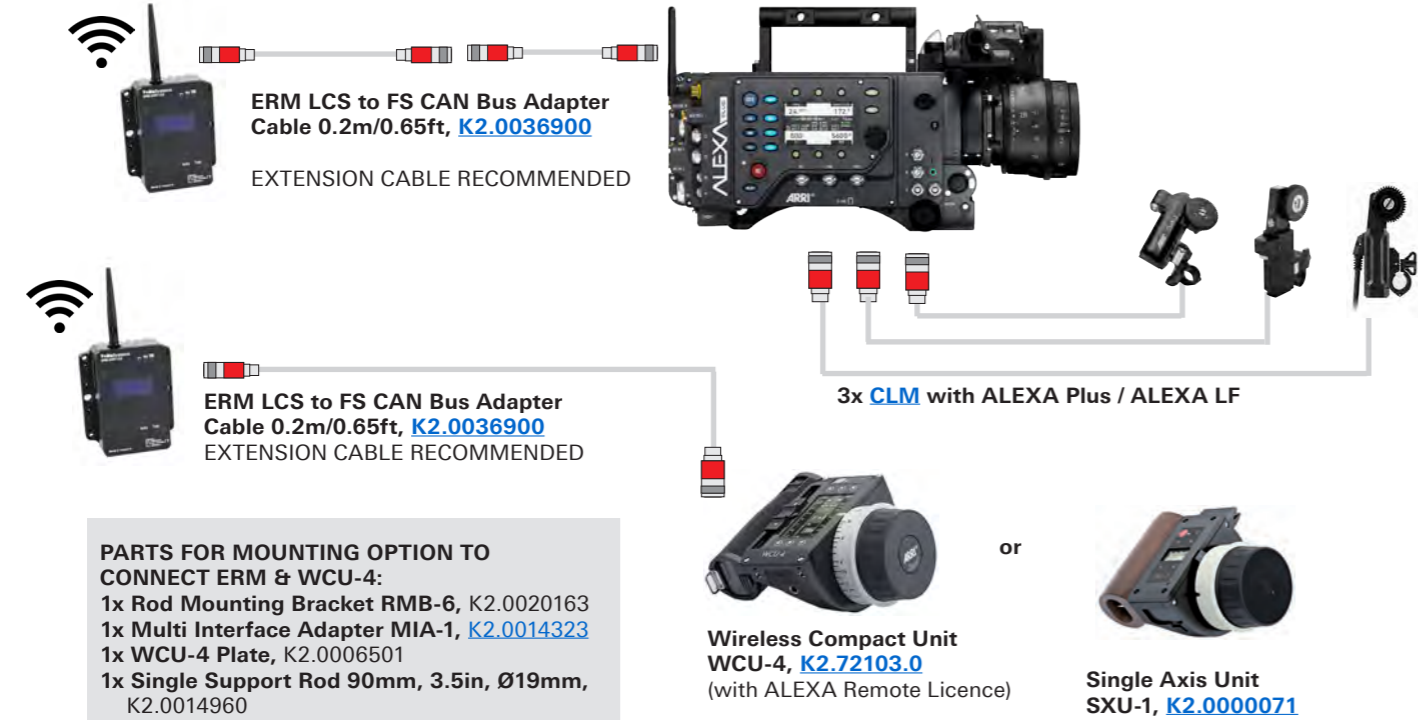

ALEXA Plus / ALEXA LF with c-force motors

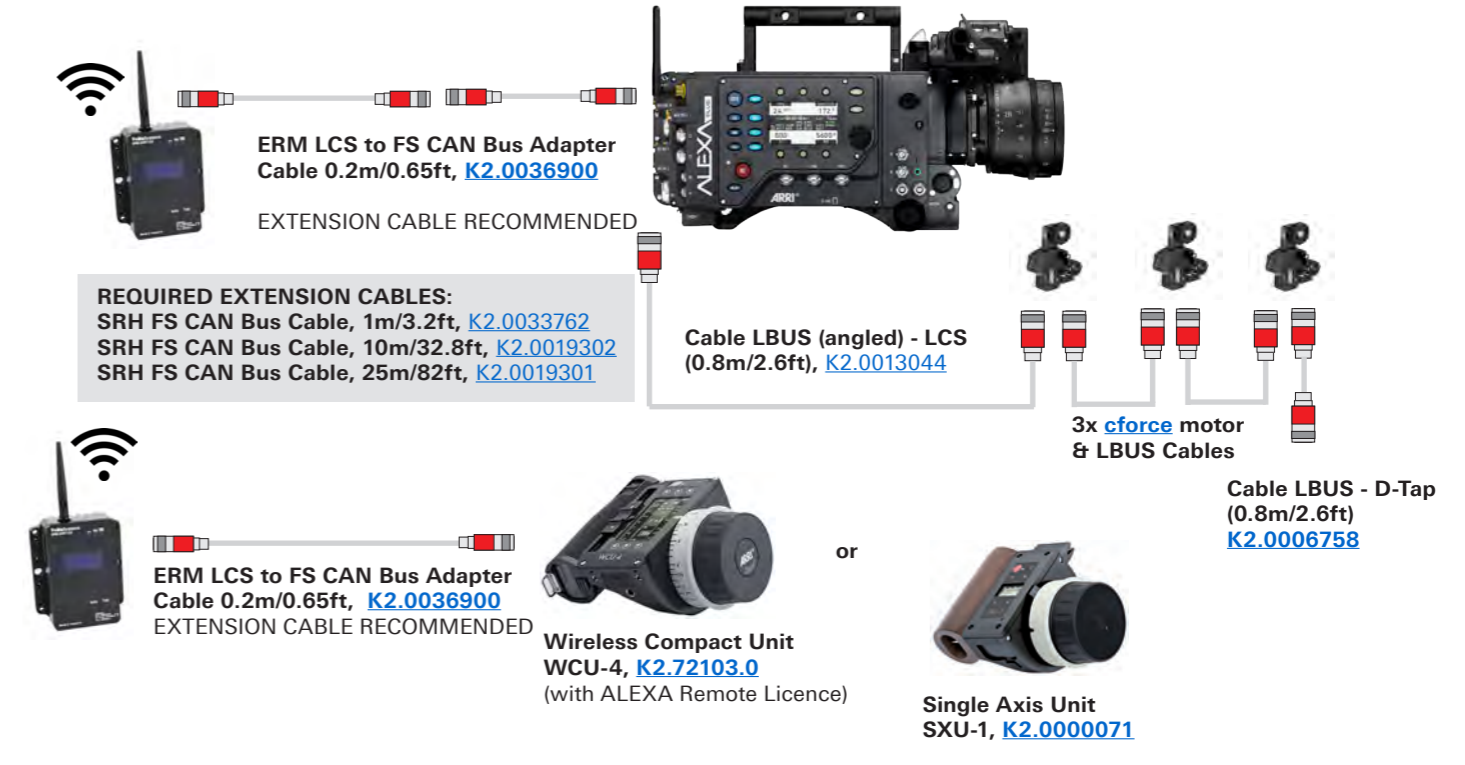

ALEXA Plus / ALEXA LF - two radio connections

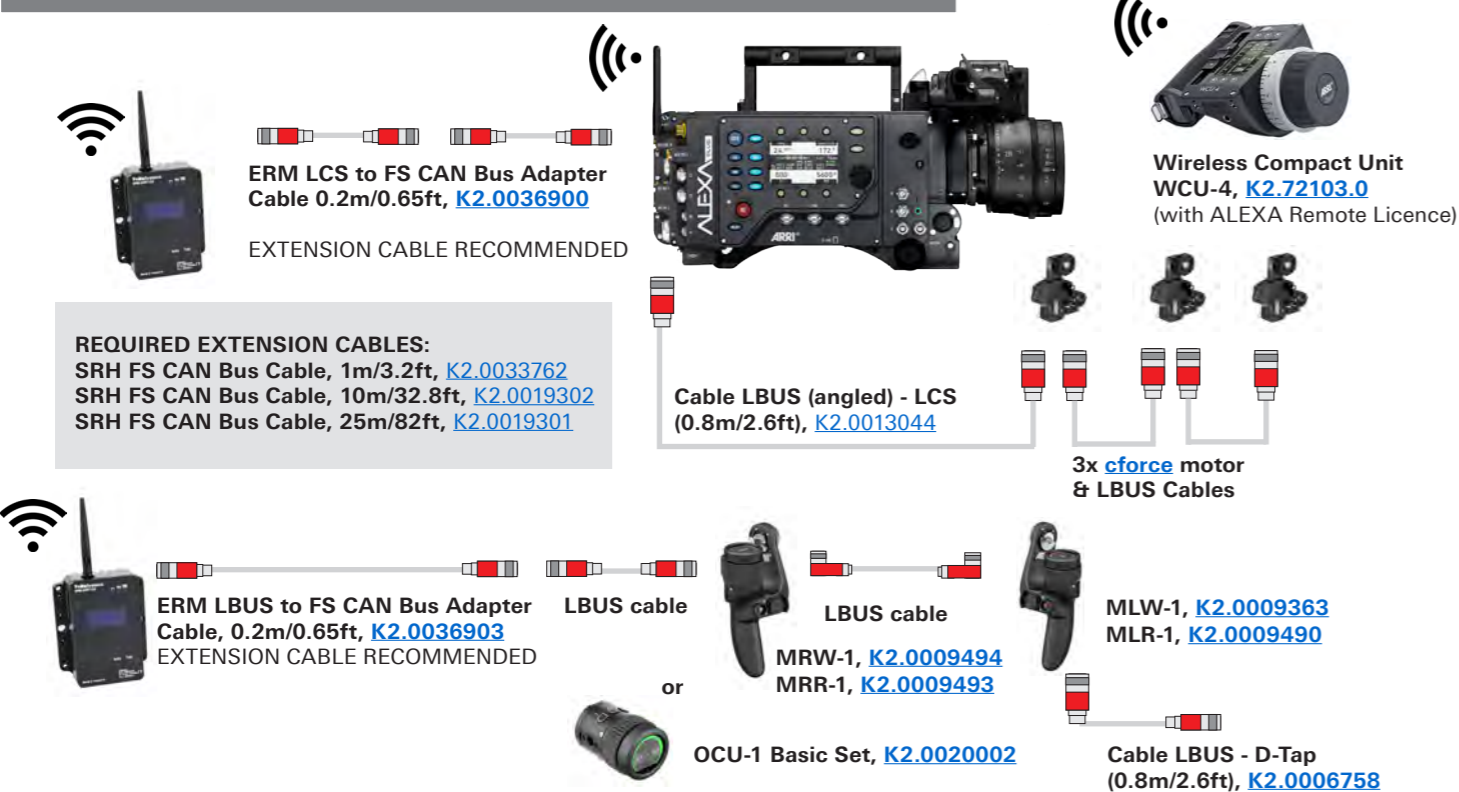

3rd Party Camera

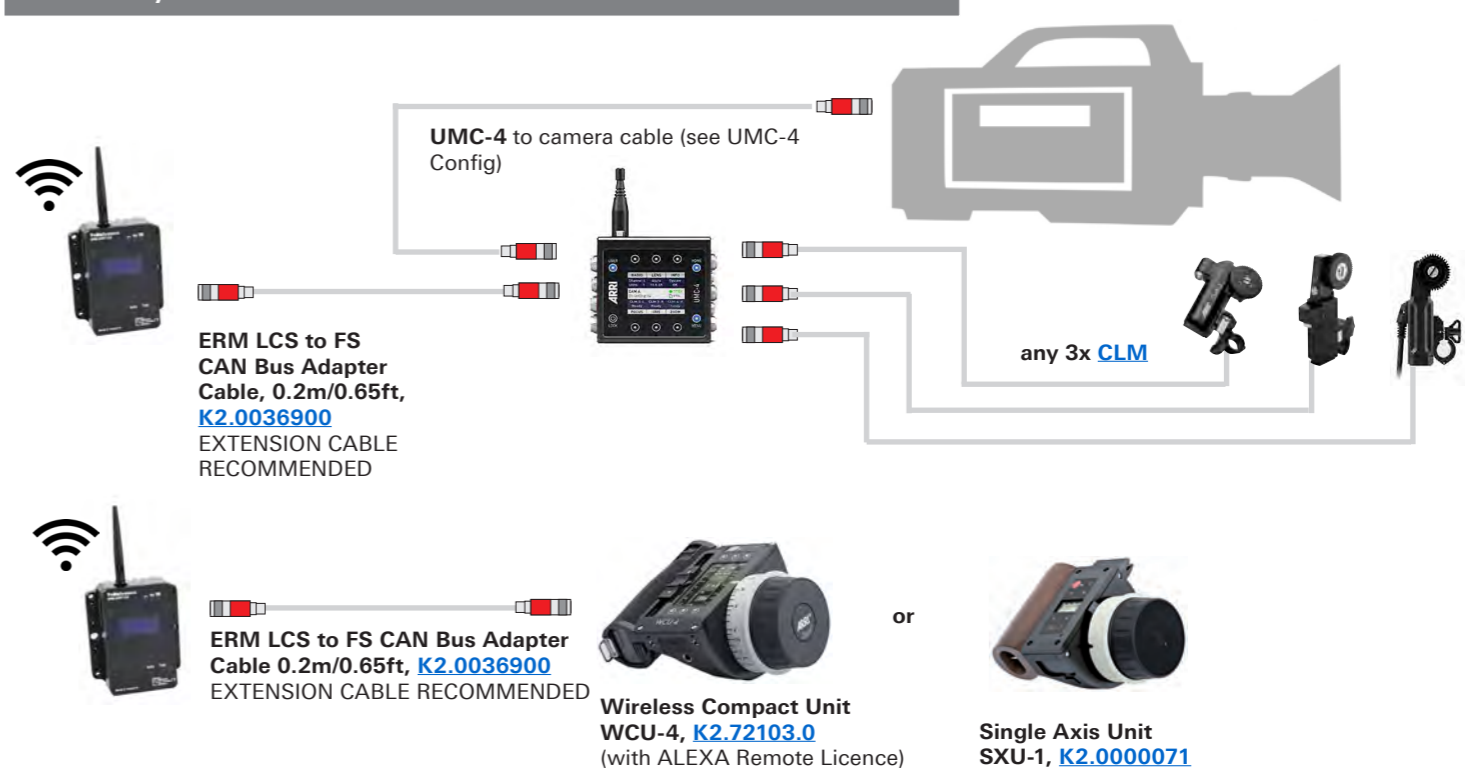

Ultrasonic Distance Measure UDM-1



Configuration Overview | 4.8.0 / 2025.10

UDM-1 Distance Measure

Ultrasonic Distance Measure UDM-1 Set

[KK.0005853](#)

Set includes:

UDM Sensor Unit, [K2.65130.0](#)

UDM Display Unit, [K2.65131.0](#)

Cable UDM-Sensor, [K2.0006459](#)



UDM Display Unit
[K2.65131.0](#)



UDM Sensor Unit
[K2.65130.0](#)

Cable UDM-Sensor (1,5m/5ft)
[K2.0006459](#) (blue cable)
connects UDM Sensor and UDM Display

Cable UDM-PSC (1,5m/5ft)
[K2.65262.0](#) (yellow cable)
Additional PSC power cable
needed

PSC Power Cable



PSC Cable System:
Both needed:
PSC cable to device
PSC power cable to power source

ARRI PSC power supply cables

K2.65206.0 PSC-XLR3	1,5m/5ft	1,5m/5ft	24 Volts battery
K2.65207.0 PSC-XLR4	1,5m/5ft	1,5m/5ft	12 Volts battery
K2.65211.0 PSC-RS	0,6m/2ft	0,6m/2ft	ARRI RS socket
K2.65212.0 PSC-FI2	0,6m/2ft	1,5m/5ft	ARRI OBB-2 battery

Cable UDM-UMC (1,5m/5ft)
[K2.65144.0](#) (yellow cable)

Connects to CUB-1



LCUBE CUB-1 Basic Set
[KK.0009001](#)



LBUS 0.2m/8", [K2.0006749](#)
LBUS 0.3m/1ft, [K2.0006750](#)
LBUS 0.5m/1.5ft, [K2.0006751](#)
LBUS 0.8m/2.5ft, [K2.0006752](#)
LBUS 1.5m/5ft, [K2.0006753](#)
LBUS 3m/10ft, [K2.0006754](#)
LBUS 6m/20ft, [K2.0006755](#)
LBUS 15m/49ft, [K2.0006756](#)



cforce motors



ALEXA Mini /
ALEXA Mini LF

Cable UDM - EXT (16p)
(0.5m/1.6ft) [K2.65261.0](#) (yellow cable)
Connects to EXT socket of ALEXA
cameras with SUP 8.0 or later



ALEXA

UDM values / Lens Data

Focus Tracking

Focus Tracking

UDM values / Lens Data

Cable UDM - SERIAL (7p) (1.5m/5ft),
[K2.65144.0](#) (yellow cable)



Connects to UMC-4



Cable UDM - SERIAL (4p) (0.8m/2.6ft)
[K2.0041172](#)



Connects to RIA-1



Cable UDM-RS (1,5m/5ft)
[K2.65240.0](#) (yellow cable)
Connects to camera RS socket



any camera
with RS



AMIRA

Cable UDM-D.Tap (0,8m/2,6ft)
[K2.0023553](#)



Cable UDM-UMC (1,5m/5ft)
[K2.65144.0](#) (yellow cable)



Connects to CUB-1



LCUBE CUB-1 Basic Set
[KK.0009001](#)

Cable CAM (10p) - RS (3p) (0.5m/1.6ft), [K2.0001606](#)



LBUS 0.2m/8", [K2.0006749](#)
LBUS 0.3m/1ft, [K2.0006750](#)
LBUS 0.5m/1.5ft, [K2.0006751](#)
LBUS 0.8m/2.5ft, [K2.0006752](#)
LBUS 1.5m/5ft, [K2.0006753](#)
LBUS 3m/10ft, [K2.0006754](#)
LBUS 6m/20ft, [K2.0006755](#)
LBUS 15m/49ft, [K2.0006756](#)

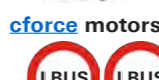

AMC-1



Hi-5 Hand Unit Body
Set, [KK.0039973](#)
Radio Module needed

UDM values /
no Lens Data

UDM values / Lens Data



Wireless Compact Unit
WCU-4, [K2.72103.0](#)



Hi-5 Hand Unit Body
Set, [KK.0039973](#)
Radio Module needed

cmotion cdistance

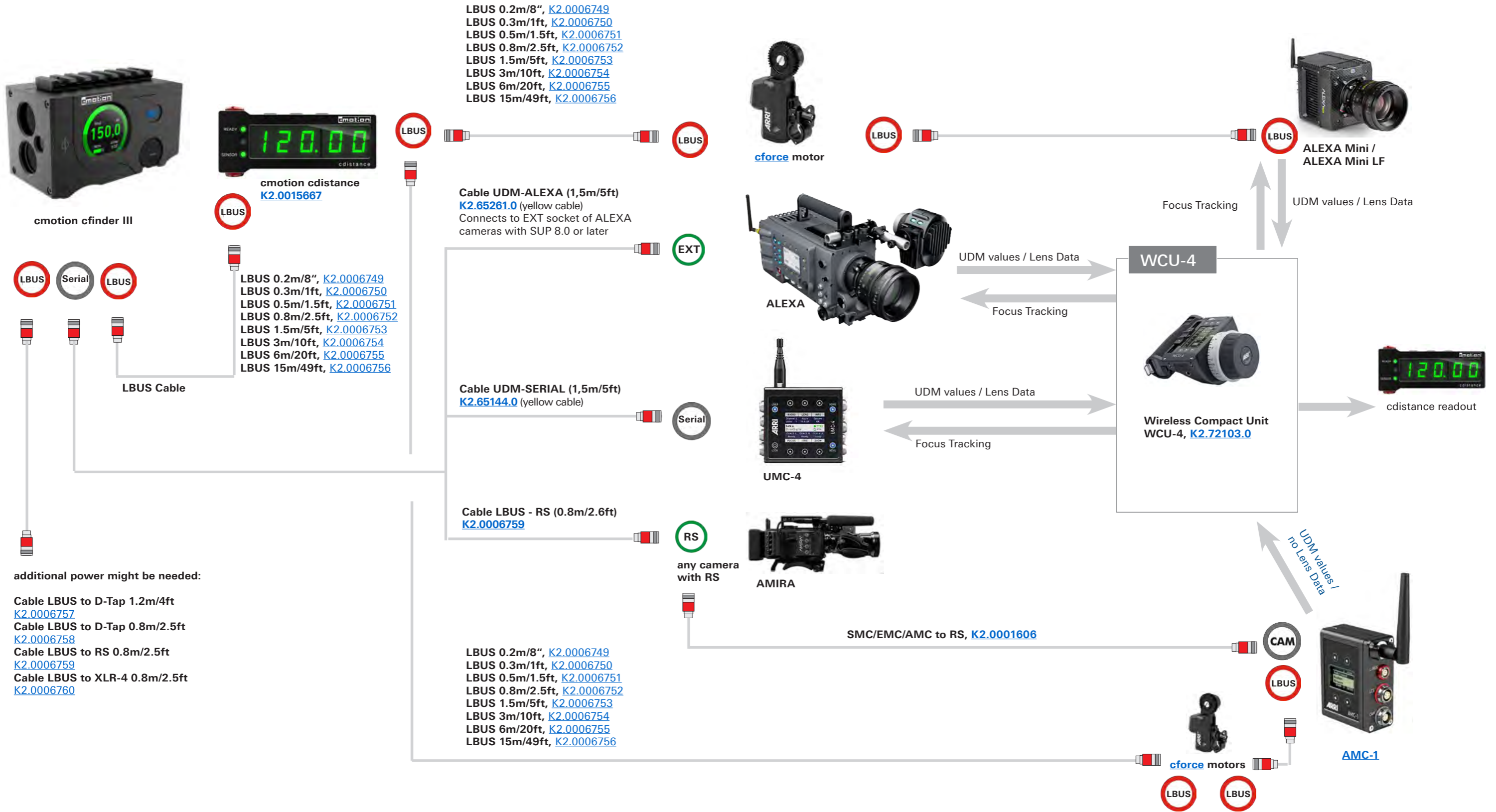

Network Interface Adapter NIA-1 - Configuration Overview



Configuration Overview | 4.9.0 / 2025.10

NIA-1 Sample Configuration

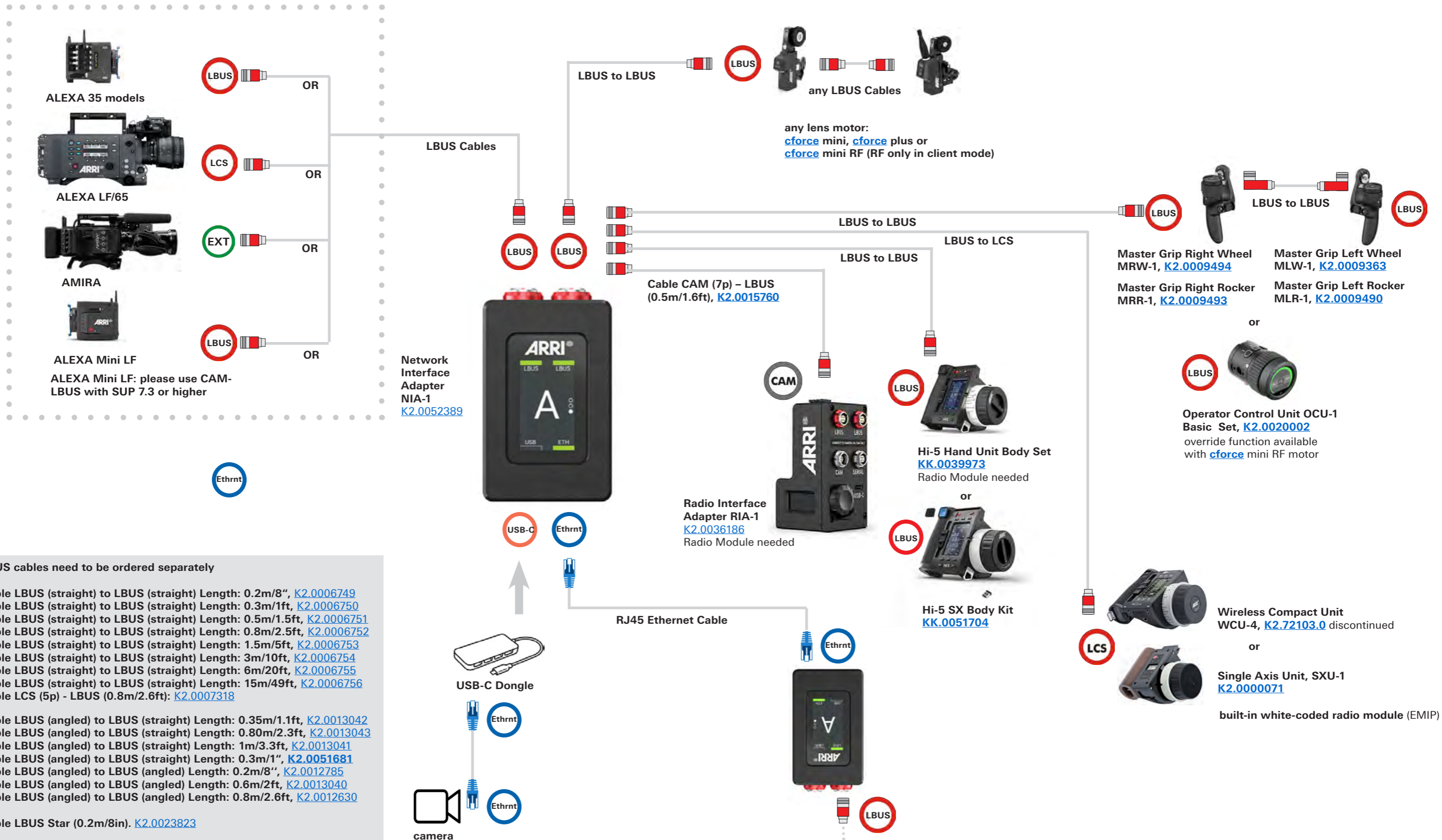

LBUS cables need to be ordered separately

- Cable LBUS (straight) to LBUS (straight) Length: 0.2m/8", [K2.0006749](#)
- Cable LBUS (straight) to LBUS (straight) Length: 0.3m/1ft, [K2.0006750](#)
- Cable LBUS (straight) to LBUS (straight) Length: 0.5m/1.5ft, [K2.0006751](#)
- Cable LBUS (straight) to LBUS (straight) Length: 0.8m/2.5ft, [K2.0006752](#)
- Cable LBUS (straight) to LBUS (straight) Length: 1.5m/5ft, [K2.0006753](#)
- Cable LBUS (straight) to LBUS (straight) Length: 3m/10ft, [K2.0006754](#)
- Cable LBUS (straight) to LBUS (straight) Length: 6m/20ft, [K2.0006755](#)
- Cable LBUS (straight) to LBUS (straight) Length: 15m/49ft, [K2.0006756](#)
- Cable LCS (5p) - LBUS (0.8m/2.6ft): [K2.0007318](#)
- Cable LBUS (angled) to LBUS (straight) Length: 0.35m/1.1ft, [K2.0013042](#)
- Cable LBUS (angled) to LBUS (straight) Length: 0.80m/2.3ft, [K2.0013043](#)
- Cable LBUS (angled) to LBUS (straight) Length: 1m/3.3ft, [K2.0013041](#)
- Cable LBUS (angled) to LBUS (straight) Length: 0.3m/1", [K2.0051681](#)
- Cable LBUS (angled) to LBUS (angled) Length: 0.2m/8", [K2.0012785](#)
- Cable LBUS (angled) to LBUS (angled) Length: 0.6m/2ft, [K2.0013040](#)
- Cable LBUS (angled) to LBUS (angled) Length: 0.8m/2.6ft, [K2.0012630](#)
- Cable LBUS Star (0.2m/8in). [K2.0023823](#)

Network Interface Adapter NIA-1 - Sample Configurations 1



Configuration Overview | 4.9.1 / 2025.10

ALEXA 35 models & NIA-1

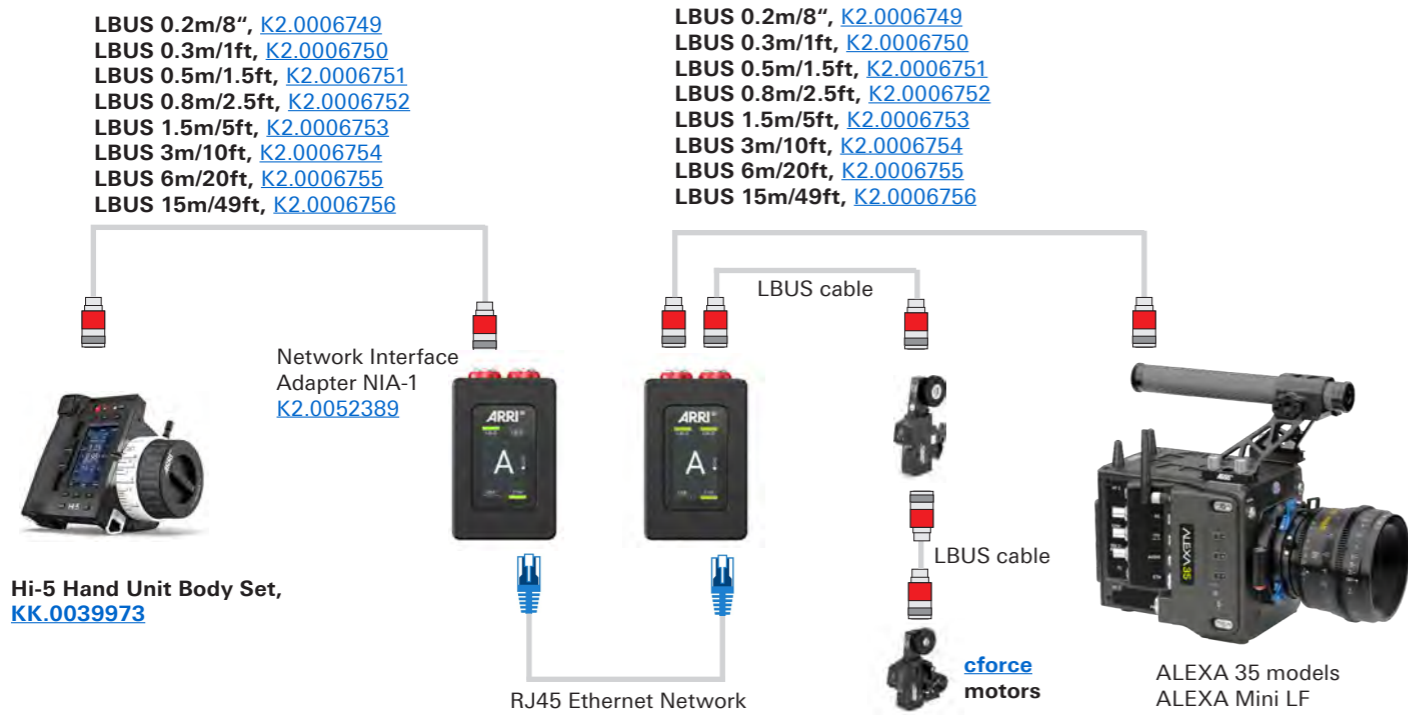

ALEXA 35 models & NIA-1 & 2x Hi-5 & RIA-1

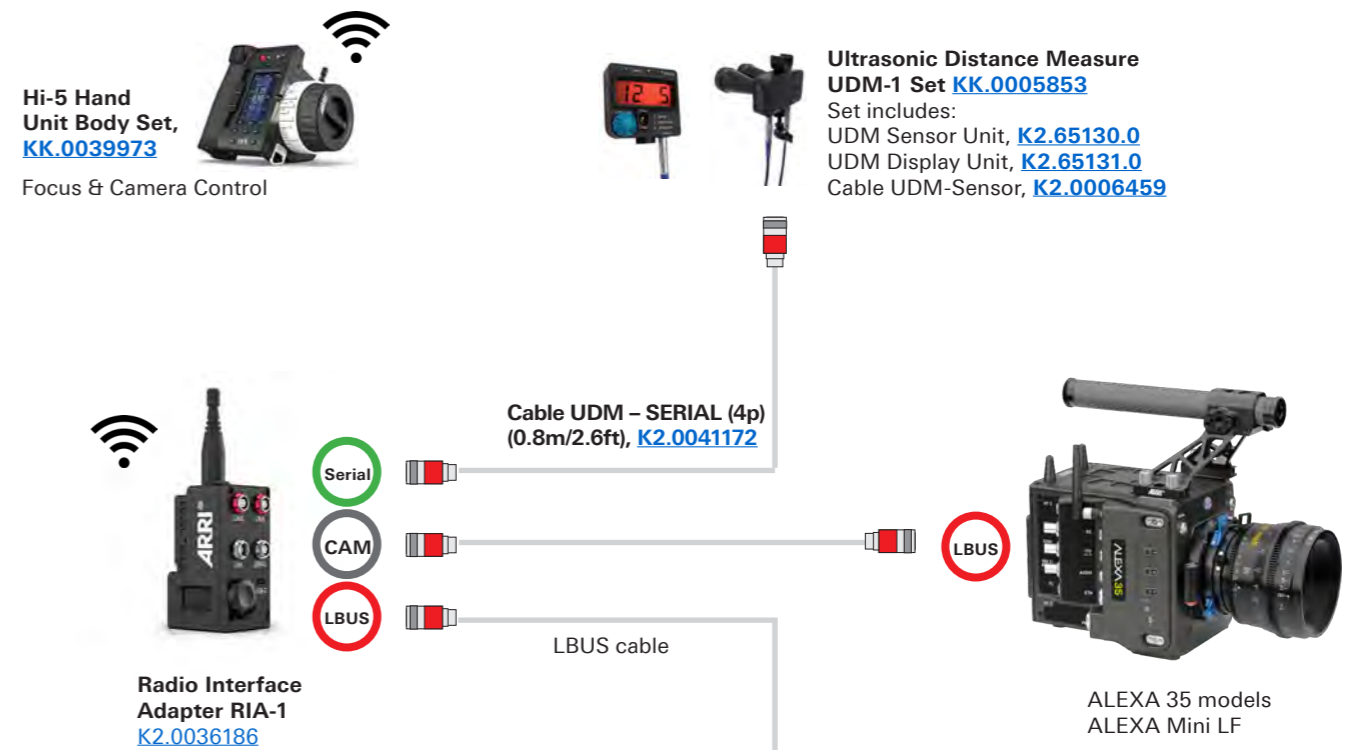

ALEXA 35 models & NIA-1 & 2x Hi-5

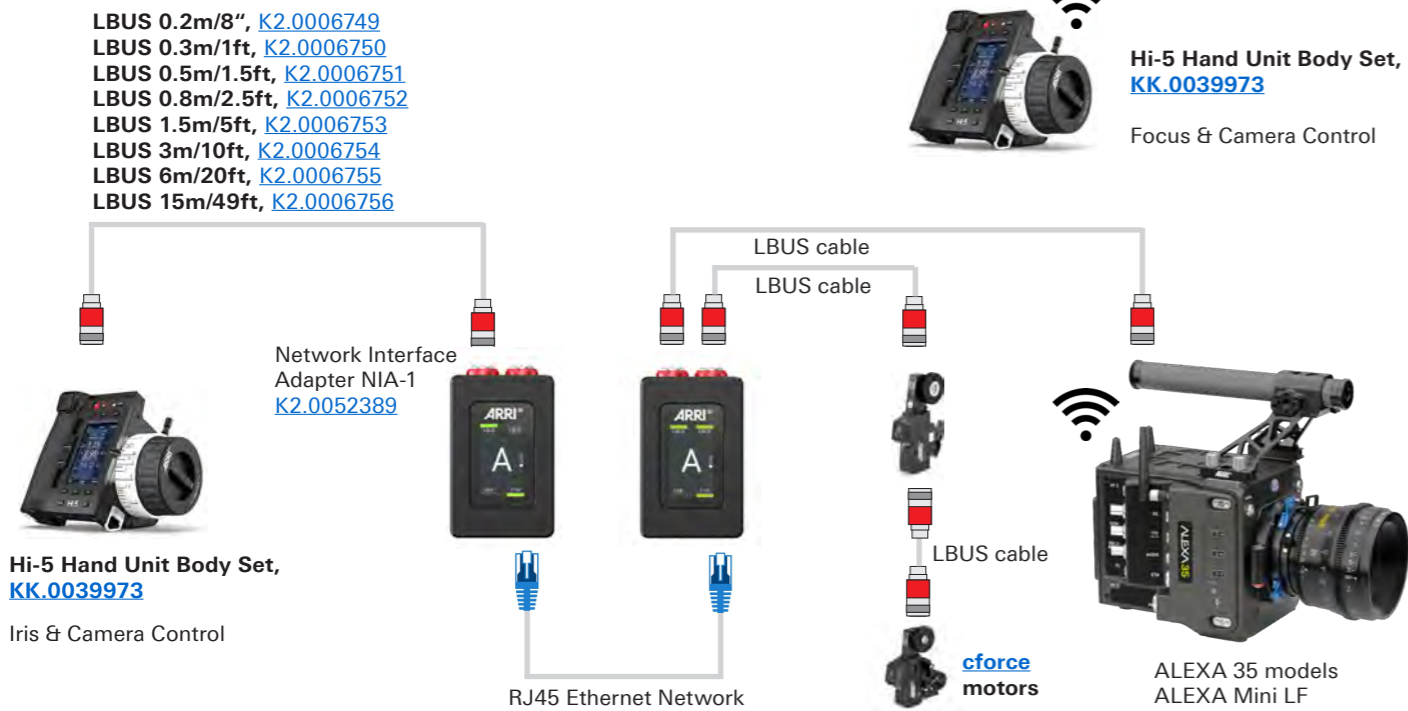

Network Interface Adapter NIA-1 - Sample Configurations 2



Configuration Overview | 4.9.2 / 2025.10

ALEXA 35 models & NIA-1 & Hi-5 & RIA-1

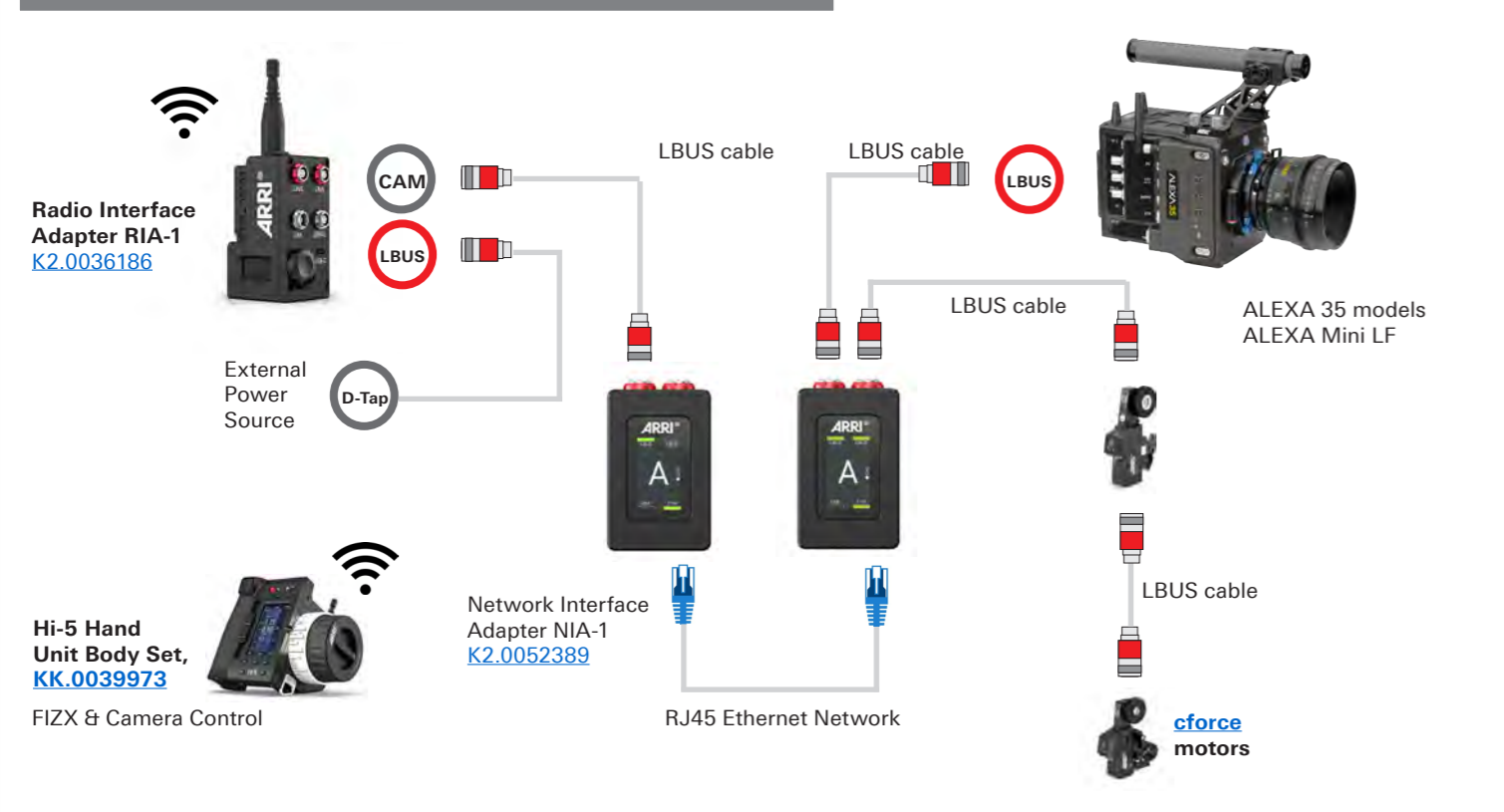

Sony Burano & NIA-1



3rd Party Control via cforce mini RF

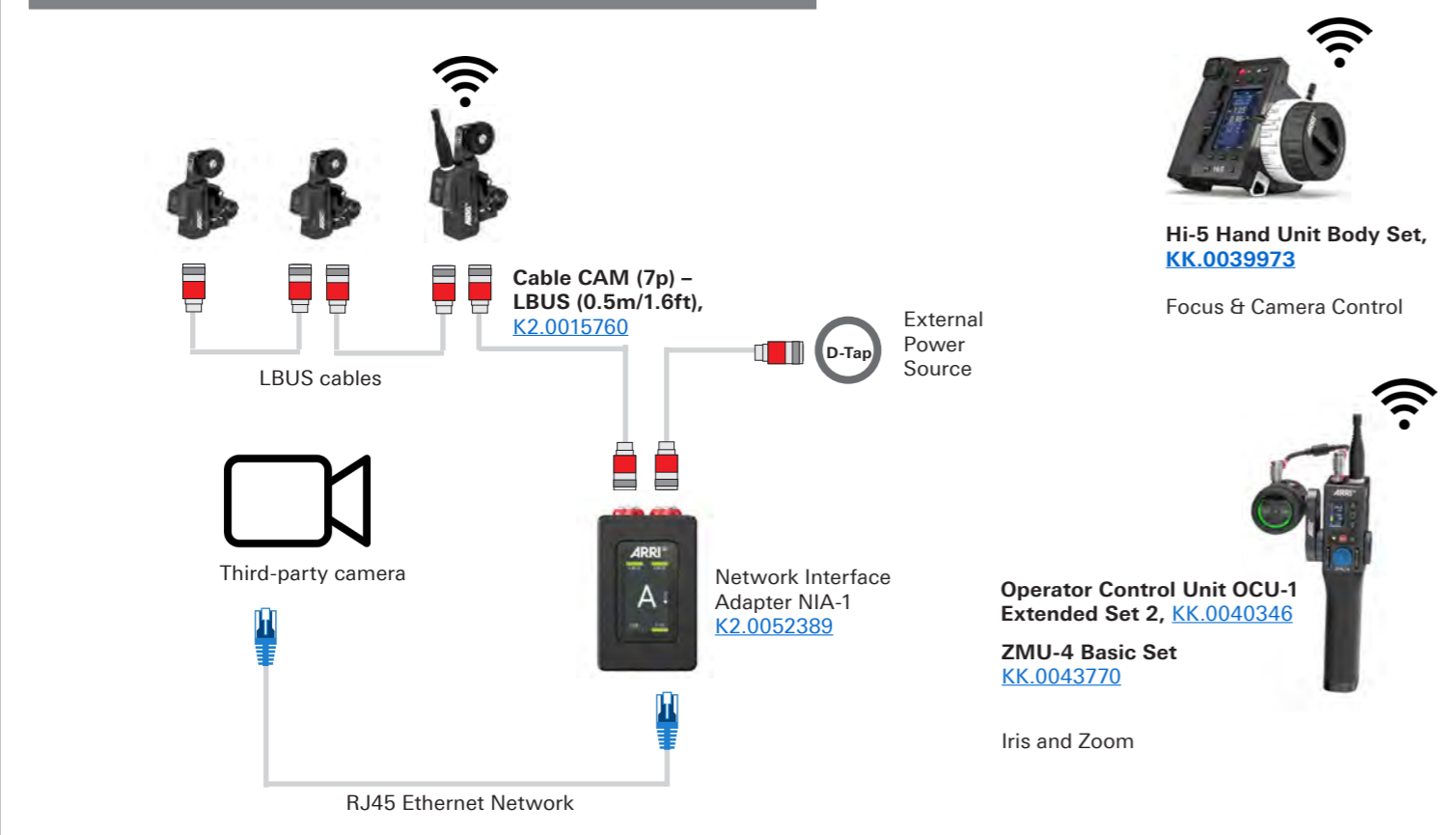

Blackmagic URSA Cine & NIA-1

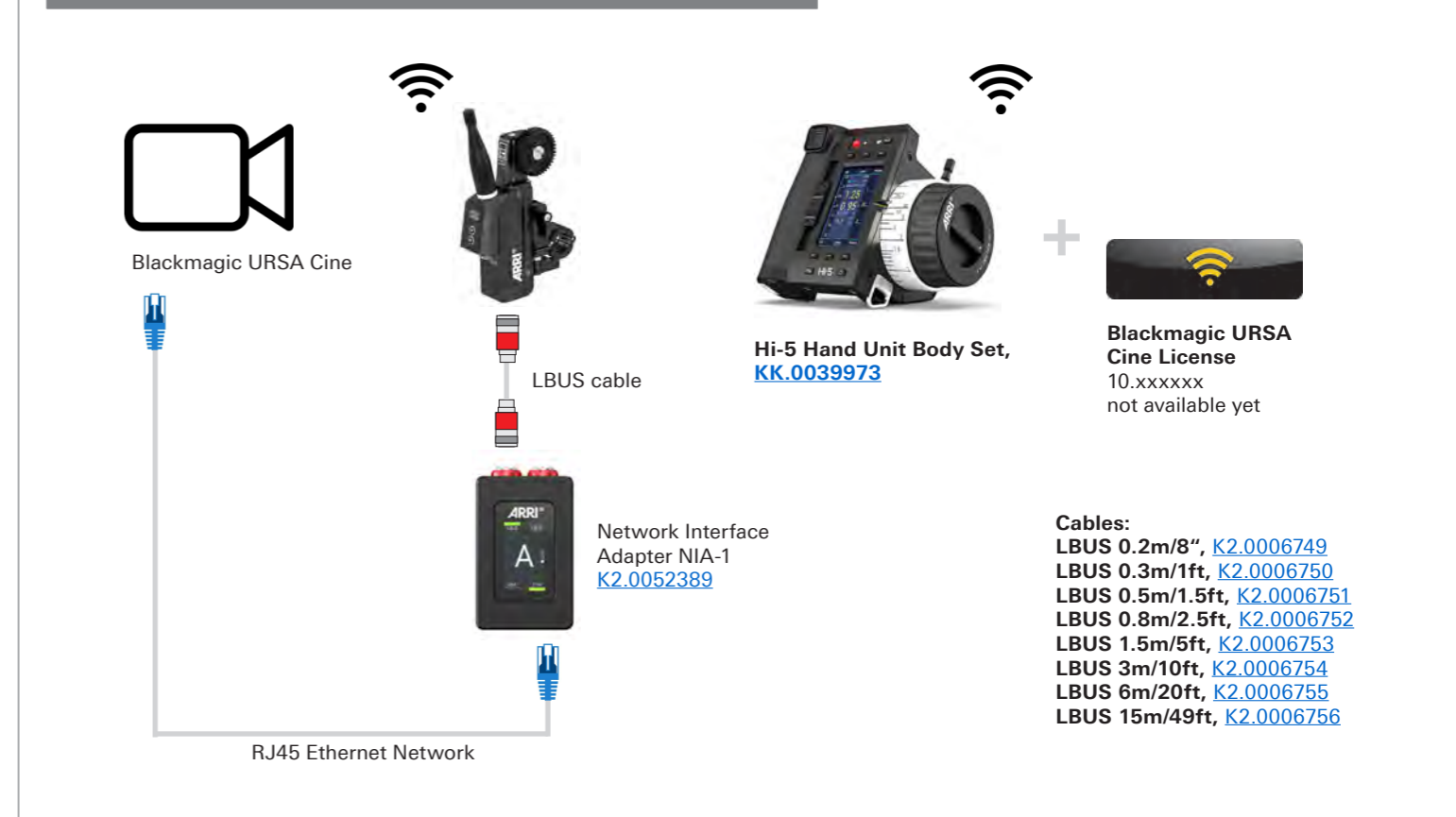

Set for Panasonic AU-EVA1

Basic Set for Panasonic AU-EVA1

[KK.0016260](#)

Consists of:

Plate for Panasonic AU-EVA1

[K2.0015883](#)

Top Plate for Panasonic AU-EVA1

[K2.0015880](#)

Support Rods 240 mm (9.4 inch), Ø 15 mm

[K2.66253.0](#)



Plate for Panasonic AU-EVA1
[K2.0015883](#)



Top Plate for Panasonic AU-EVA1
[K2.0015880](#)

Pro Set for Panasonic AU-EVA1

[KK.0016261](#)

Consists of:

Plate for Panasonic AU-EVA1

[K2.0015883](#)

Top Plate for Panasonic AU-EVA1

[K2.0015880](#)

Support Rods 240 mm (9.4 inch), Ø 15 mm

[K2.66253.0](#)

Monitor Bracket for Panasonic AU-EVA1

[K2.0016259](#)

HGA-3 for Panasonic AU-EVA1

[K2.0016711](#)

Battery Adapter Plate BAP-1

[K2.0006471](#)

15 mm LWS Rod Console

[K2.65264.0](#)

Support Rods 140 mm (5.5 inch), Ø 15 mm (2x)

[K2.66254.0](#)



Monitor Bracket for Panasonic AU-EVA1, [K2.0016259](#) *



HGA-3 for Panasonic AU-EVA1 [K2.0016711](#)

Sets for RED DSMC2

Basic Cine Set for RED DSMC2

[KK.0010059](#)

Consists of:

Cine plate for RED DSMC2

[K2.0008886](#)

Support Rods 240 mm (9.4 inch), Ø 15 mm

[K2.66253.0](#)

Support Rods 140 mm (5.5 inch), Ø 15 mm

[K2.66254.0](#)

Bridge Plate Sled, BPS-2

[K2.66260.0](#)

Bottom Dovetail Plate 300mm/12in

[K2.0015896](#)

Top plate for RED DSMC2

[K2.0009664](#)

Top handle for RED DSMC2

[K2.0008903](#)

Monitor bracket for RED DSMC2

[K2.0009582](#)



Cine Plate for RED DSMC2,
K2.0008886



Top Plate for RED DSMC2,
[K2.0009664](#)

Pro Cine Set 19 mm for RED DSMC2

[KK.0010066](#)

Consists of:

Cine plate for RED DSMC2

[K2.0008886](#)

Support Rods 240 mm (9.4 inch), Ø 15 mm

[K2.66253.0](#)

Support Rods 140 mm (5.5 inch), Ø 15 mm

[K2.66254.0](#)

Top plate for RED DSMC2

[K2.0009664](#)

Top handle for RED DSMC2

[K2.0008903](#)

Monitor bracket for RED DSMC2

[K2.0009582](#)

Bridge Plate BP-8 Set (19 mm Rods)

[K2.47090.0](#)



Broadcast Plate for RED DSMC2,
[K2.0009614](#)



Top Handle for RED DSMC2,
[K2.0008903](#)

Pro Cine Set 15 mm for RED DSMC2

[KK.0010068](#)

Consists of:

Cine plate for RED DSMC2

[K2.0008886](#)

Support Rods 240 mm (9.4 inch), Ø 15 mm

[K2.66253.0](#)

Support Rods 140 mm (5.5 inch), Ø 15 mm

[K2.66254.0](#)

Top plate for RED DSMC2

[K2.0009664](#)

Top handle for RED DSMC2

[K2.0008903](#)

Monitor bracket for RED DSMC2

[K2.0009582](#)

Bridge Plate BP-9 Set (15 mm Rods)

[K2.47091.0](#)



Monitor Bracket for RED DSMC2,
[K2.0009582](#)



Viewfinder Bracket for RED DSMC2, [K2.0012522](#)

Broadcast Set for RED DSMC2

[KK.0010069](#)

Consists of:

Broadcast plate for RED DSMC2

[K2.0009614](#)

Support Rods 240 mm (9.4 inch), Ø 15 mm

[K2.66253.0](#)

Quick Release Plate, QRP-1

[K2.0000399](#)

Top plate for RED DSMC2

[K2.0009664](#)

Top handle for RED DSMC2

[K2.0008903](#)

Monitor bracket for RED DSMC2

[K2.0009582](#)

Brackets for Electronic Viewfinders

Viewfinder Cross Pipe RMB-3 Set

[KK.0013311](#)

Consists of:

Viewfinder Cross Pipe

[K2.0013302](#)

Rod Mounting Bracket RMB-3

[K2.0006186](#)



Monitor Bracket for Canon LM-V1/2, [K2.0015520](#) *



Monitor Bracket for Panasonic AU-EVA1,
[K2.0016259](#) *

EVF bracket set for Sony DVF-EL200

[KK.0022326](#)

Consists of:

Mini Viewfinder Bracket MVB-1

[K2.0006140](#)

EVF bracket for Sony DVF-EL200 (Venice)

[K2.0021525](#)

EVF bracket set for Zacuto Gratical

[KK.0010048](#)

Consists of:

Viewfinder mounting bracket for ALEXA Mini (MVB-1)

[K2.0006140](#)

EVF bracket for Zacuto Gratical

[K2.0008624](#)



Viewfinder Bracket for VariCam, [K2.0010580](#)



EVF bracket for Zacuto Gratical, [K2.0008624](#)

EVF bracket set for Canon Monitor Unit

[KK.0010060](#)

Consists of:

Viewfinder mounting bracket for ALEXA Mini (MVB-1)

[K2.0006140](#)

EVF bracket for Canon Monitor Unit

[K2.0008955](#)



EVF bracket for Small HD Sidefinder, K2.0008711



Viewfinder Bracket for Canon EVF, [K2.0008955](#)

EVF bracket set for VariCam

[KK.0012560](#)

Consists of:

Viewfinder mounting bracket for ALEXA Mini (MVB-1)

[K2.0006140](#)

EVF bracket for VariCam

[K2.0010580](#)

EVF bracket set for RED Bomb Viewfinder

[KK.0012695](#)

Consists of:

Viewfinder mounting bracket for ALEXA Mini (MVB-1)

[K2.0006140](#)

EVF bracket for RED Bomb Viewfinder

[K2.0008712](#)



Viewfinder Bracket for RED Bomb, [K2.0008712](#)



EVF Bracket for Canon EVF-V70, [K2.0013195](#)

EVF bracket set for RED DSMC2

[KK.0012693](#)

Consists of:

Viewfinder mounting bracket for ALEXA Mini (MVB-1)

[K2.0006140](#)

EVF bracket for RED DSMC2

[K2.0012522](#)



Viewfinder Bracket for RED DSMC2, [K2.0012522](#)



EVF bracket for Sony DVF-EL200 (Venice), [K2.0021525](#)



Viewfinder Cross Pipe
[K2.0013302](#)

* discontinued items

only as long as stock is available (single item)

Configuration Overview | 5.1.1 / 2025.12

Sholder Config with Clip-on Matt Box



Extended Pro Set for ETERNA 55, [K0.0055797](#)

- includes:
- [KK.0055440](#) 1x Basic Set for ETERNA 55
 - K2.0024161 1x Compact Shoulder Pad CSP-2
 - [K2.0054184](#) 2x NATO Rail Clamp NRC-6 (Rosette)
 - K2.0050467 1x Lightweight Support LWS-7
 - [K2.66253.0](#) 1x Support Rods 240mm/9.4in, 15mm
 - [K2.0055362](#) 1x Rear Side Bracket Right for ETERNA 55
 - K2.0048324 1x NATO Rail Clamp NRC-2
 - K2.0055230 1x Top Plate for ETERNA 55
 - [K2.0017270](#) 1x Center Camera Handle CCH-4



Pro Set for ETERNA 55, [KK.0055439](#)

- includes:
- [K2.0055237](#) 1x Top NATO Rail for ETERNA 55
 - K2.0055230 1x Top Plate for ETERNA 55
 - [K2.0055235](#) 2x Side Bracket for ETERNA 55
 - [K2.0055233](#) 1x Base Plate for ETERNA 55
 - [K2.0055362](#) 1x Rear Side Bracket Right for ETERNA 55
 - [K2.0017270](#) 1x Center Camera Handle CCH-4
 - [K2.66253.0](#) 1x Support Rods 240mm/9.4in, 15mm
 - K2.0048324 1x NATO Rail Clamp NRC-2
 - [K2.66255.0](#) 1x 15mm Reduction Insert
 - [K2.0047776](#) 1x NATO Rail Clamp NRC-1
 - K2.0023549 1x Compact Bridge Plate CBP-5 (19mm)

Lightweight Configuration



Extended Basic Set for ETERNA 55, [K0.0055796](#)

- includes:
- [KK.0055440](#) 1x Basic Set for ETERNA 55
 - K2.0024161 1x Compact Shoulder Pad CSP-2
 - [K2.0054184](#) 2x NATO Rail Clamp NRC-6 (Rosette)
 - K2.0050467 1x Lightweight Support LWS-7
 - [K2.66253.0](#) 1x Support Rods 240mm/9.4in, 15mm
 - [K2.0055362](#) 1x Rear Side Bracket Right for ETERNA 55
 - K2.0048324 1x NATO Rail Clamp NRC-2



Basic Set for ETERNA 55, [KK.0055440](#)

- includes:
- [K2.0055237](#) 1x Top NATO Rail for ETERNA 55
 - [K2.66255.0](#) 1x 15mm Reduction Insert
 - [K2.0047776](#) 1x NATO Rail Clamp NRC-1
 - [K2.0055233](#) 1x Base Plate for ETERNA 55
 - [K2.0055235](#) 2x Side Bracket for ETERNA 55
 - [K2.0055367](#) 1x Lightweight Tripod Plate LTP-1



Lightweight Support LWS-7, K2.0050467

ETERNA 55 - Single Components



- Viewfinder Set for ETERNA 55, K0.0055753**
includes:
- [K2.0034309](#) 1x Rod Mounting Bracket RMB-8
 - K2.0048510 1x Viewfinder Adapter VFA-4
 - [K2.0013302](#) 1x Viewfinder Cross Pipe



Top Plate for ETERNA 55, K2.0055230



Camera Center Handle CCH-4, [K2.0017270](#)



Cage Top Handle CTH-2, [K2.0054160](#)



Top NATO Rail for ETERNA 55, [K2.0055237](#)



Rear Side Bracket Right for ETERNA 55, [K2.0055362](#)
mounts directly on the camera



Side Bracket for ETERNA 55, [K2.0055235](#)



Base Plate for ETERNA 55, [K2.0055233](#)



Side Bracket for ETERNA 55, [K2.0055235](#)



Lightweight Support LWS-7, K2.0050467



Stabilizer Adapter Mount SAM-5, K2.0024572



Stabilizer Adapter Mount SAM-6 450mm/18in, K2.0039405



Stabilizer Adapter Mount SAM-6 355mm/14in, K2.0048425



Stabilizer Adapter Mount SAM-6 250mm/9.85in, K2.0024508



Stabilizer Adapter Mount SAM-7, K2.0024511



Stabilizer Adapter Mount SAM-8, K2.0044479



Stabilizer Adapter Mount SAM-9, K2.0041949



Lightweight Tripod Plate LTP-1, [K2.0055367](#)



Compact Shoulder Pad CSP-2, K2.0024161



Please note:

Due to the height of the Fujifilm ETERNA 55, rods mounted via the Compact Bridge Plates CBP-5/6 and the BPA-6 are positioned approximately 10 mm below the standard heights defined for 15 mm LWS and 15/19 mm studio rod standards. To achieve the standard 15 mm LWS height, the Base Plate for Eterna 55 used together with the LWS-7 provides full compatibility. The 19 mm studio standard height is not supported with this camera configuration.

NATO Rail Components



NATO Rail Bar NRB-160 [K2.0051823](#)



NATO Rail Clamp NRC-1, [K2.0047776](#)



NATO Rail Clamp NRC-3, [K2.0049419](#)



NATO Rail Clamp NRC-5, [K2.0047771](#)



Swivel Mechanism Bracket [K2.0052697](#)



NATO Rail Clamp NRC-2, K2.0048324



NATO Rail Clamp NRC-4, [K2.0047801](#)



NATO Rail Clamp NRC-6 (Rosette), [K2.0054184](#)

Sets for Sony BURANO

Basic Cine Set for Sony BURANO, [KK.0050113](#)

includes:
[K2.0049751](#) 1x Top Plate for Sony BURANO
[K2.0043726](#) 1x Plate for Sony Venice 1/2
[K2.0017138](#) 1x Bridge Plate Adapter BPA-5
[K2.65264.0](#) 1x 15mm LWS Rod Console
[K2.66253.0](#) 1x Support Rods 240mm/9.4in, 15mm



Basic Broadcast Set for Sony BURANO, [KK.0050114](#)

includes:
[K2.0049751](#) 1x Top Plate for Sony BURANO
[K2.0043726](#) 1x Plate for Sony Venice 1/2
[K2.0043749](#) 1x Broadcast Shoulder Adapter BSA-1
[K2.65264.0](#) 1x 15mm LWS Rod Console
[K2.66253.0](#) 1x Support Rods 240mm/9.4in, 15mm



Pro Cine Set for Sony BURANO, [KK.0050115](#)

includes:
[K2.0049751](#) 1x Top Plate for Sony BURANO
[K2.0043726](#) 1x Plate for Sony Venice 1/2
[K2.0049819](#) 1x Side Bracket Right for Sony BURANO
[K2.0049816](#) 1x Side Bracket Left for Sony BURANO
[K2.0049904](#) 1x Rear Side Bracket Right for Sony BURANO
[K2.0047776](#) 1x NATO Rail Clamp NRC-1
[K2.0048324](#) 1x NATO Rail Clamp NRC-2
[K2.0017270](#) 1x Center Camera Handle CCH-4
[K2.0017138](#) 1x Bridge Plate Adapter BPA-5
[K2.66255.0](#) 2x 15mm Reduction Insert
[K2.65264.0](#) 1x 15mm LWS Rod Console
[K2.66253.0](#) 1x Support Rods 240mm/9.4in, 15mm
[K2.0006186](#) 1x Rod Mounting Bracket RMB-3



Pro Broadcast Set for Sony BURANO, [KK.0050116](#)

includes:
[K2.0049751](#) 1x Top Plate for Sony BURANO
[K2.0043726](#) 1x Plate for Sony Venice 1/2
[K2.0049819](#) 1x Side Bracket Right for Sony BURANO
[K2.0049816](#) 1x Side Bracket Left for Sony BURANO
[K2.0049904](#) 1x Rear Side Bracket Right for Sony BURANO
[K2.0047776](#) 1x NATO Rail Clamp NRC-1
[K2.0048324](#) 1x NATO Rail Clamp NRC-2
[K2.0017270](#) 1x Center Camera Handle CCH-4
[K2.0043749](#) 1x Broadcast Shoulder Adapter BSA-1
[K2.66255.0](#) 2x 15mm Reduction Insert
[K2.65264.0](#) 1x 15mm LWS Rod Console
[K2.66253.0](#) 1x Support Rods 240mm/9.4in, 15mm
[K2.0006186](#) 1x Rod Mounting Bracket RMB-3



Parts for Sony BURANO



Top Plate for Sony BURANO
[K2.0049751](#)



NATO Rail Clamp NRC-1
[K2.0047776](#)



NATO Rail Clamp RC-2
[K2.0048324](#)



Side Bracket Left for Sony BURANO
[K2.0049816](#)



Side Bracket Right for Sony BURANO,
[K2.0049819](#)



Rear Side Bracket Right for Sony BURANO,
[K2.0049904](#)

Sets for Sony VENICE 1/2

Basic Cine Set for Sony Venice 1/2, [KK.0043758](#)

includes:
[K2.0043699](#) 1x Top Plate for Sony Venice 1/2
[K2.0043726](#) 1x Plate for Sony Venice 1/2
[K2.0017138](#) 1x Bridge Plate Adapter BPA-5
[K2.66252.0](#) 1x Support Rods 340mm/13.4in, 15mm
[K2.0017270](#) 1x Center Camera Handle CCH-4



Basic Broadcast Set for Sony Venice 1/2, [KK.0043757](#)

includes:
[K2.0043699](#) 1x Top Plate for Sony Venice 1/2
[K2.0043726](#) 1x Plate for Sony Venice 1/2
[K2.0043749](#) 1x Broadcast Shoulder Adapter BSA-1
[K2.0017270](#) 1x Center Camera Handle CCH-4
[K2.66252.0](#) 1x Support Rods 340mm/13.4in, 15mm



Pro Cine Set for Sony Venice 1/2, [KK.0043759](#)

includes:
[K2.0043699](#) 1x Top Plate for Sony Venice 1/2
[K2.0043726](#) 1x Plate for Sony Venice 1/2
[K2.0017138](#) 1x Bridge Plate Adapter BPA-5
[K2.66252.0](#) 1x Support Rods 340mm/13.4in, 15mm
[K2.0017270](#) 1x Center Camera Handle CCH-4
[K2.0043731](#) 1x Side Bracket Right for Sony Venice 1/2
[K2.0043725](#) 1x Side Bracket Left for Sony Venice 1/2
[K2.0021525](#) 1x EVF Bracket for Sony DVF-EL200 (Venice)
[K2.0006140](#) 1x Mini Viewfinder Bracket MVB-1



Pro Broadcast Set for Sony Venice 1/2, [KK.0043753](#)

includes:
[K2.0043699](#) 1x Top Plate for Sony Venice 1/2
[K2.0043726](#) 1x Plate for Sony Venice 1/2
[K2.0043749](#) 1x Broadcast Shoulder Adapter BSA-1
[K2.66252.0](#) 1x Support Rods 340mm/13.4in, 15mm
[K2.0017270](#) 1x Center Camera Handle CCH-4
[K2.0043731](#) 1x Side Bracket Right for Sony Venice 1/2
[K2.0043725](#) 1x Side Bracket Left for Sony Venice 1/2
[K2.0021525](#) 1x EVF Bracket for Sony DVF-EL200 (Venice)
[K2.0006140](#) 1x Mini Viewfinder Bracket MVB-1



Parts for Sony VENICE 1/2



Top Plate for Sony Venice 1/2
[K2.0043699](#)



Plate for Sony Venice 1/2
[K2.0043726](#)



Broadcast Shoulder Adapter BSA-1,
[K2.0043749](#)



Side Bracket Right for Sony Venice 1/2
[K2.0043731](#)



Side Bracket Left for Sony Venice 1/2
[K2.0043725](#)



Rosette Adapter RA-6 (pair)
[K2.0024574](#)

Accessories for Sony VENICE Extension Unit 1/2 & Sony VENICE Ext. Mini



Configuration Overview | 5.2.1 / 2025.07

Sets for Sony VENICE Extension Unit 1/2



Basic Set for Venice Extension Unit 1/2, KK.0047971 includes:
[K2.0024564](#) 1x Base Plate for Venice Ext. Unit
[K2.0039457](#) 1x Top Plate for Venice Ext. Unit
[K2.0024566](#) 1x Side Bracket Right for Venice Ext. Unit
[K2.0024761](#) 1x Side Bracket Left for Venice Ext. Unit
[K2.0024569](#) 1x Cable Clamp for Venice Ext. Unit
[K2.0024573](#) 1x Back Plate for Venice Ext. Unit
[K2.0024574](#) 1x Rosette Adapters, RA-6, pair
[K2.0047941](#) 1x Back Plate 2 for Venice Ext. Unit



Pro Set for Venice Extension Unit 1/2, KK.0047962, includes:
[K2.66253.0](#) 1x Support Rods 240mm/9.4in, 15mm
[K2.66254.0](#) 1x Support Rods 140mm/5.5in, 15mm
[K2.66227.0](#) 1x Cage Top Handle, CTH-1
[K2.66255.0](#) 1x 15mm Reduction Insert
[K2.65264.0](#) 1x 15mm LWS Rod Console
[K2.0024564](#) 1x Base Plate for Venice Ext. Unit
[K2.0039457](#) 1x Top Plate for Venice Ext. Unit
[K2.0024566](#) 1x Side Bracket Right for Venice Ext. Unit
[K2.0024761](#) 1x Side Bracket Left for Venice Ext. Unit
[K2.0024569](#) 1x Cable Clamp for Venice Ext. Unit
[K2.0024574](#) 1x Rosette Adapters, RA-6, pair
[K2.0024573](#) 1x Back Plate for Venice Ext. Unit
 K2.0024965 1x Wooden Handgrip WHG-1
 K2.0006186 1x Rod Mounting Bracket RMB-3
[K2.0047941](#) 1x Back Plate 2 for Venice Ext. Unit
[K2.0017138](#) 1x Bridge Plate Adapter BPA-5

Sets for Sony VENICE Ext. Mini



Basic Set for Sony Venice Ext. Mini, KK.0054193 includes:
[K2.0054187](#) 1x Base Plate for Sony VENICE Ext. Mini
[K2.0054520](#) 1x Top Plate for Sony VENICE Ext. Mini
[K2.0054179](#) 2x Side Bracket for Sony VENICE Ext. Mini
 K2.0054522 2x NATO Rail for Sony VENICE Ext. Mini
[K2.0054201](#) 1x Cable Clamp for Sony VENICE Ext. Mini
[K2.0047776](#) 1x NATO Rail Clamp NRC-1
[K2.66255.0](#) 1x 15mm Reduction Insert



Pro Set for Sony Venice Ext. Mini, KK.0054192 includes:
[K2.0054187](#) 1x Base Plate for Sony VENICE Ext. Mini
[K2.0054520](#) 1x Top Plate for Sony VENICE Ext. Mini
[K2.0054189](#) 1x Back Plate for Sony VENICE Ext. Mini
[K2.0054179](#) 2x Side Bracket for Sony VENICE Ext. Mini
 K2.0054522 3x NATO Rail for Sony VENICE Ext. Mini
[K2.0054201](#) 1x Cable Clamp for Sony VENICE Ext. Mini
[K2.0054184](#) 2x NATO Rail Clamp NRC-6 (Rosette)
[K2.66255.0](#) 1x 15mm Reduction Insert
 K2.0024745 1x Bridge Plate Adapter BPA-6
[K2.0054160](#) 1x Cage Top Handle CTH-2
[K2.0047776](#) 1x NATO Rail Clamp NRC-1
[K2.0054216](#) 1x Wooden Handle Grip WHG-3 right
[K2.0054215](#) 1x Wooden Handle Grip WHG-3 left
[K2.66254.0](#) 1x Support Rods 140mm/5.5in, 15mm

Parts for Sony VENICE Extension Unit 1/2



Base Plate for Venice Ext. Unit, [K2.0024564](#)



Top Plate for Venice Ext. Unit, [K2.0039457](#)



Cable Clamp for Venice Ext. Unit [K2.0024569](#)



Back Plate for Venice Ext. Unit [K2.0024573](#)



Back Plate 2 for Venice Ext. Unit, [K2.0047941](#)



Side Bracket Left for Venice Ext. Unit [K2.0024761](#)



Side Bracket Right for Venice Ext. Unit, [K2.0024566](#)

Parts for Sony VENICE Ext. Mini



Top Plate for Sony VENICE Ext. Mini, [K2.0054520](#)



Base Plate for Sony VENICE Ext. Mini, [K2.0054187](#)



Back Plate for Sony VENICE Ext. Mini, [K2.0054189](#)



Side Bracket for Sony VENICE Ext. Mini, [K2.0054179](#)



Cable Clamp for Sony VENICE Ext. Mini, [K2.0054201](#)



NATO Rail Clamp NRC-6 (Rosette), [K2.0054184](#)



Cage Top Handle CTH-2, [K2.0054160](#)



Wooden Handgrip WHG-3 right, [K2.0054216](#)



Wooden Handgrip WHG-3 left, [K2.0054215](#)

for more compatible NATO Rail parts please see Config 5.6.1

Compatibility Base Plate for Sony VENICE Ext. Mini

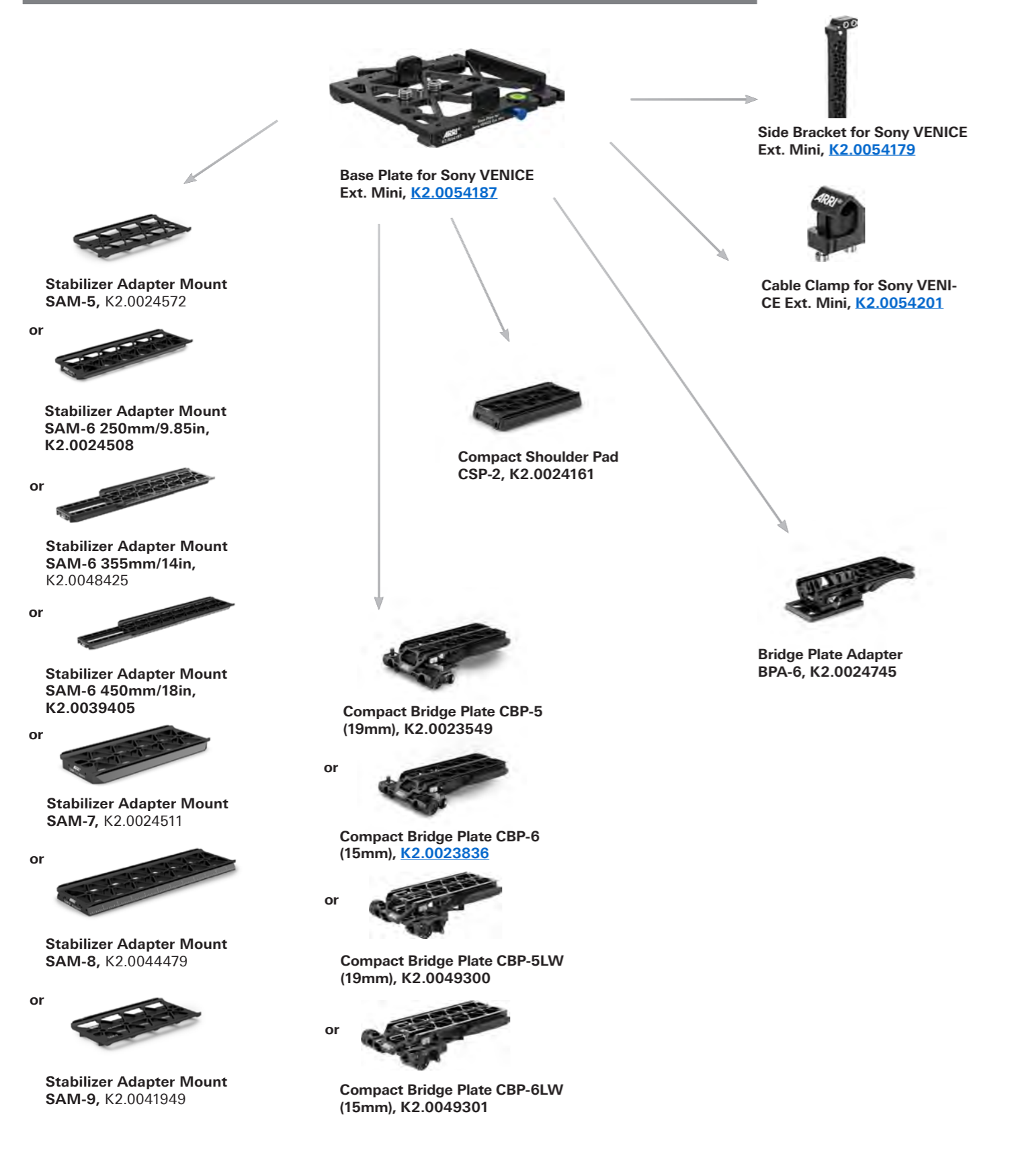

Compatibility Top Plate for Sony VENICE Ext. Mini

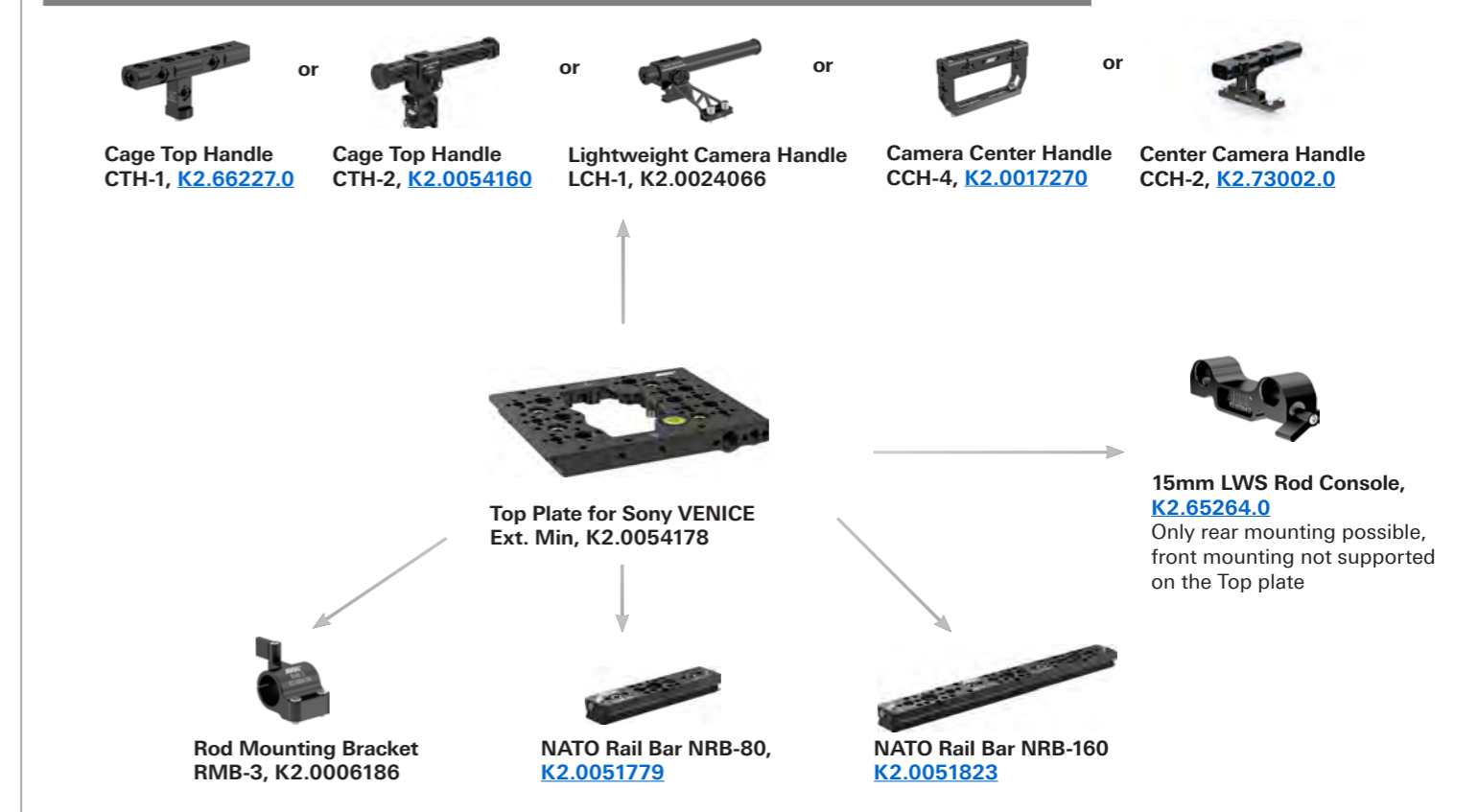

Compatibility Back Plate for Sony VENICE Ext. Mini

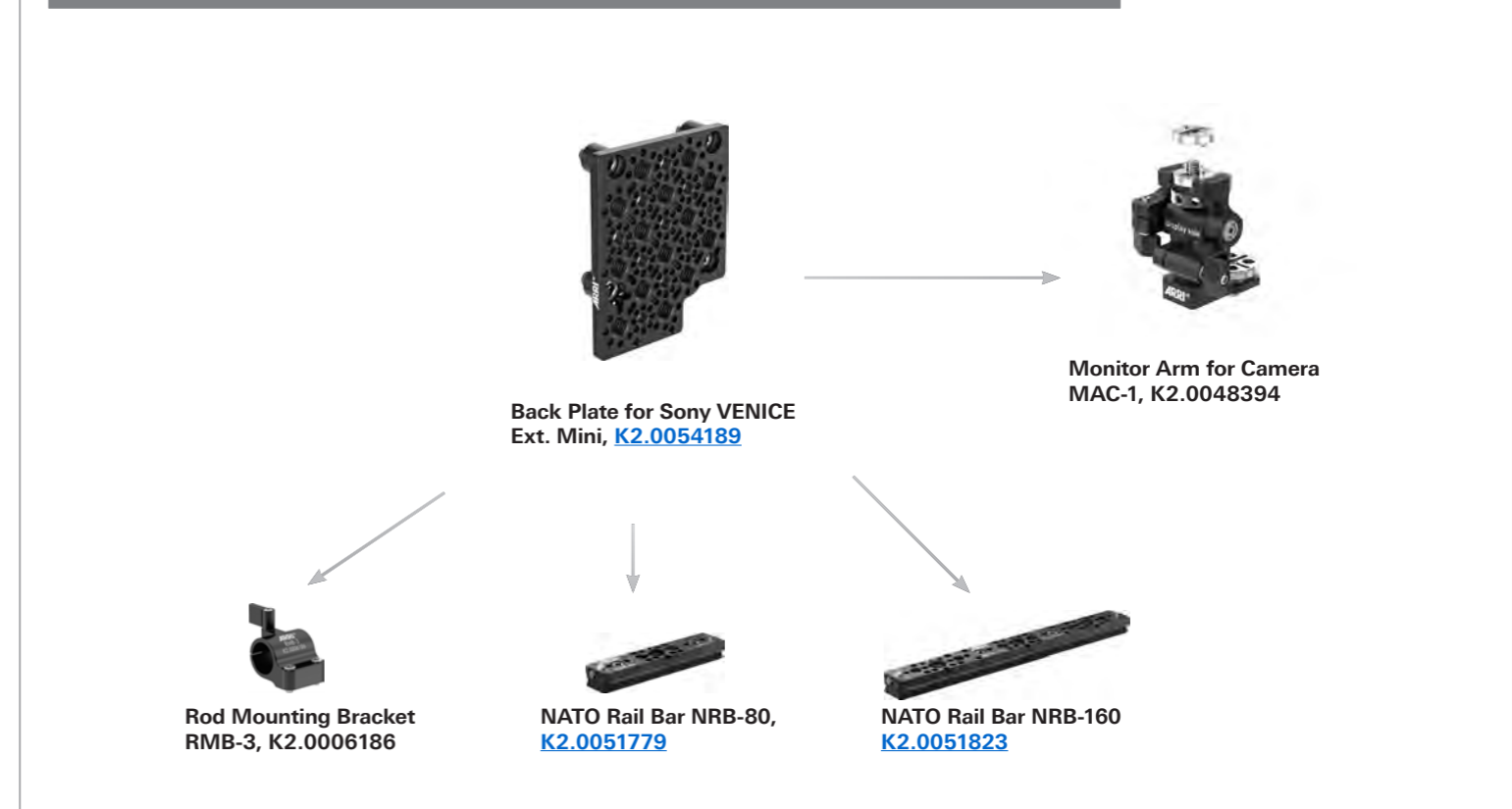

Sets for Canon EOS C300 MkIII / C500 MkII



Basic Set for Canon C300 MkIII / C500 MkII [KK.0033625](#)
 Consists of:
 Plate for Canon C300 Mk III / C500 MkII [K2.0033439](#)
 Bridge Plate Adapter BPA-5 [K2.0017138](#)
 Support Rods 340mm, Ø15mm [K2.66252.0](#)



Pro Set for Canon C300 MkIII / C500 MkII [KK.0037326](#)
 Consists of:
 Top Plate for Canon C300 MkIII / C500 MkII [K2.0033441](#)
 Plate for Canon C500 MkII [K2.0033439](#)
 Bridge Plate Adapter BPA-5 [K2.0017138](#)
 Camera Center Handle CCH-4 [K2.0017270](#)
 Sliding Adapter for CCH-4 [K2.0019282](#)
 Rod Mounting Bracket RMB-3 [K2.0006186](#)
 15mm Reduction Insert [K2.66255.0](#)
 Mini Viewfinder Bracket MVB-1 [K2.0006140](#)
 Bracket for Canon LM-V1 [K2.0015520](#)
 Support Rods 340mm, Ø15mm [K2.66252.0](#)
 Side Bracket Left for C300 MkIII / C500 MkII [K2.0037185](#)
 Side Bracket Right for C300 MkIII / C500 MkII [K2.0037183](#)



Plate for Canon C300 MkIII / C500 MkII, [K2.0033439](#)



Top Plate for Canon C300 MkIII / C500 MkII, [K2.0033441](#) *



Side Bracket Left for C300 MkIII / C500 MkII [K2.0037185](#)



Side Bracket Right for C300 MkIII / C500 MkII [K2.0037183](#)

* discontinued items
no stock available anymore

Sets for Canon C300 / C300 Mk II / C500



Basic Cine Set for Canon C300 Mk II [KK.0007700](#)
 Consists of:
 Cine Plate C300 MkII [K2.0006864](#)
 Support Rods 340 mm (13.4"), Ø 15 mm [K2.66252.0](#)
 Shoulder Pad CSP-1 [K2.0006807](#)

Pro Cine Set for Canon C300 Mk II [KK.0007705](#)
 Consists of:
 Cine Plate C300 MkII [K2.0006864](#)
 Support Rods 340 mm (13.4"), Ø 15 mm [K2.66252.0](#)
 Top Plate C300 MkII [K2.0006859](#)
 Center Camera Handle, CCH-2 [K2.73002.0](#)
 3/8" Accessory Shoe Adapter, 18.65mm square [K2.54077.0](#)
 Shoulder Pad CSP-1 [K2.0006807](#)

Pro Cine Set for Canon C300 Mk II + BP-8 [KK.0007703](#)
 Consists of:
 Cine Plate C300 MkII [K2.0006864](#)
 Support Rods 340 mm (13.4"), Ø 15 mm [K2.66252.0](#)
 Top Plate C300 MkII [K2.0006859](#)
 Center Camera Handle, CCH-2 [K2.73002.0](#)
 Bridge Plate BP-8 Set (19 mm Rods) [K2.47090.0](#)
 3/8" Accessory Shoe Adapter, 18.65mm square [K2.54077.0](#)
 Shoulder Pad CSP-1 [K2.0006807](#)

Pro Cine Set for Canon C300 Mk II + BP-9 [KK.0007704](#)
 Consists of:
 Cine Plate C300 MkII [K2.0006864](#)
 Support Rods 340 mm (13.4"), Ø 15 mm [K2.66252.0](#)
 Top Plate C300 MkII [K2.0006859](#)
 Center Camera Handle, CCH-2 [K2.73002.0](#)
 Bridge Plate BP-9 Set (15 mm Rods) [K2.47091.0](#)
 3/8" Accessory Shoe Adapter, 18.65mm square [K2.54077.0](#)
 Shoulder Pad CSP-1 [K2.0006807](#)

Pro Broadcast Set for Canon C300 Mk II [KK.0007702](#)
 Consists of:
 Broadcast Plate C300 MkII [K2.0006797](#)
 Support Rods 340 mm (13.4"), Ø 15 mm [K2.66252.0](#)
 Top Plate C300 MkII [K2.0006859](#)
 Center Camera Handle, CCH-2 [K2.73002.0](#)
 3/8" Accessory Shoe Adapter, 18.65mm square [K2.54077.0](#)

Basic Broadcast Set for Canon C300 Mk II [KK.0007699](#)
 Consists of:
 Broadcast Plate C300 MkII [K2.0006797](#)
 Support Rods 340 mm (13.4"), Ø 15 mm [K2.66252.0](#)

Pro Broadcast Set for Canon C300 Mk II + QRP-1, [KK.0007701](#)
 Consists of:
 Broadcast Plate C300 MkII [K2.0006797](#)
 Support Rods 340 mm (13.4"), Ø 15 mm [K2.66252.0](#)
 Top Plate C300 MkII [K2.0006859](#)
 Center Camera Handle, CCH-2 [K2.73002.0](#)
 Quick Release Plate, QRP-1 [K2.0000399](#)
 3/8" Accessory Shoe Adapter, 18.65mm square [K2.54077.0](#)

Sets for Canon C200

Basic Cine Set for Canon C200 [KK.0016044](#)
 Consists of:
 Adapter Plate for Canon C200 [K2.0015518](#)
 Cine Plate C300 Mk II [K2.0006864](#)
 Support Rods 340 mm (13.4 inch), Ø 15 mm [K2.66252.0](#)
 Shoulder Pad CSP-1 [K2.0006807](#)

Pro Cine Set for Canon C200 [KK.0016051](#)
 Consists of:
 Adapter Plate for Canon C200 [K2.0015518](#)
 Cine Plate C300 Mk II [K2.0006864](#)
 Support Rods 340 mm (13.4 inch), Ø 15 mm [K2.66252.0](#)
 Top Plate for Canon C200 [K2.0015513](#)
 Center Camera Handle, CCH-2 [K2.73002.0](#)
 Shoulder Pad CSP-1 [K2.0006807](#)
 Monitor Bracket for Canon C200 [K2.0015520](#)
 Viewfinder Mounting Bracket MVB-1 [K2.0006140](#)

Pro Broadcast Set for Canon C200 + QRP-1 [KK.0016052](#)
 Consists of:
 Adapter Plate for Canon C200 [K2.0015518](#)
 Broadcast Plate C300 Mk II [K2.0006797](#)
 Support Rods 340 mm (13.4 inch), Ø 15 mm [K2.66252.0](#)
 Top Plate for Canon C200 [K2.0015513](#)
 Center Camera Handle, CCH-2 [K2.73002.0](#)
 Quick Release Plate, QRP-1 [K2.0000399](#)
 Monitor Bracket for Canon C200 [K2.0015520](#)
 Viewfinder Mounting Bracket MVB-1 [K2.0006140](#)



Adapter Plate for Canon C200 [K2.0015518](#) *



Top Plate for Canon C200 [K2.0015513](#) *



Monitor Bracket for Canon C200 [K2.0015520](#) *

* discontinued items
only as long as stock is available (single item)

Viewfinder Brackets for Canon



Viewfinder Bracket for Canon C700, [K2.0013195](#)



EVF bracket for Canon Monitor Unit, [K2.0008955](#)

Sets for Canon C700

Pro Set for Canon C700 [KK.0013598](#)
 Consists of:
 Plate for Canon C700 [K2.0013191](#)
 Support Rods 240 mm (9.4 inch), Ø 15 mm [K2.66253.0](#)
 Top Plate for Canon C700 [K2.0013229](#)
 Viewfinder mounting bracket Mini (MVB-1) [K2.0006140](#)
 Viewfinder bracket for Canon C700 [K2.0013195](#)
 Center Camera Handle, CCH-2 [K2.73002.0](#)

Cine 19mm Pro Set for Canon C700 [KK.0013597](#)
 Consists of:
 Plate for Canon C700 [K2.0013191](#)
 Support Rods 240 mm (9.4 inch), Ø 15 mm [K2.66253.0](#)
 Top Plate for Canon C700 [K2.0013229](#)
 Viewfinder mounting bracket Mini (MVB-1) [K2.0006140](#)
 Viewfinder bracket for Canon C700 [K2.0013195](#)
 Center Camera Handle, CCH-2 [K2.73002.0](#)
 Bridge Plate BP-8 Set (19 mm Rods) [K2.47090.0](#)

Cine 15mm Pro Set for Canon C700 [KK.0013599](#)
 Consists of:
 Plate for Canon C700 [K2.0013191](#)
 Support Rods 240 mm (9.4 inch), Ø 15 mm [K2.66253.0](#)
 Top Plate for Canon C700 [K2.0013229](#)
 Viewfinder mounting bracket Mini (MVB-1) [K2.0006140](#)
 Viewfinder bracket for Canon C700 [K2.0013195](#)
 Center Camera Handle, CCH-2 [K2.73002.0](#)
 Bridge Plate BP-9 Set (15 mm Rods) [K2.47091.0](#)

Broadcast Pro Set for Canon C700 [KK.0013596](#)
 Consists of:
 Plate for Canon C700 [K2.0013191](#)
 Support Rods 240 mm (9.4 inch), Ø 15 mm [K2.66253.0](#)
 Top Plate for Canon C700 [K2.0013229](#)
 Viewfinder mounting bracket Mini (MVB-1) [K2.0006140](#)
 Viewfinder bracket for Canon C700 [K2.0013195](#)
 Center Camera Handle, CCH-2 [K2.73002.0](#)
 Quick Release Plate, QRP-1 [K2.0000399](#)



Plate for Canon C700 [K2.0013191](#)



Top Plate for Canon C700 [K2.0013229](#)



Viewfinder Bracket for Canon C700, [K2.0013195](#)



Handgrip Adapter HGA-1 Set LBS-2 [KK.0005673](#)
 Consists of (without rods):
 Handgrip Adapter, HGA-1 [K2.66191.0](#)
 Lightweight Bridge Support, LBS-2 [K2.66275.0](#)

Accessories for Canon Camera EOS C400 & compatible Nato Rail System



Configuration Overview | 5.3.1 / 2025.04

Sets for Canon EOS C400



Basic Cine Set for Canon EOS C400

- Consists of:
- Top Plate for Canon EOS C400 [K2.0051221](#)
 - Plate for Canon EOS C400 [K2.0051262](#)
 - Bridge Plate Adapter BPA-5 [K2.0017138](#)
 - 15mm LWS Rod Console [K2.65264.0](#)
 - Support Rods 240mm/9.4in, Ø15mm [K2.66253.0](#)



Pro Cine Set for Canon C400

- Consists of:
- Top Plate for Canon EOS C400 [K2.0051221](#)
 - Plate for Canon EOS C400 [K2.0051262](#)
 - Bridge Plate Adapter BPA-5 [K2.0017138](#)
 - Center Camera Handle CCH-4 [K2.0017270](#)
 - Side Bracket Right for Canon EOS C400 [K2.0051223](#)
 - Side Bracket Left for Canon EOS C400 [K2.0051222](#)
 - Rear Side Bracket Right for Canon EOS C400 [K2.0051224](#)
 - NATO Rail Clamp NRC-1 [K2.0047776](#)
 - NATO Rail Clamp NRC-2 [K2.0048324](#)
 - Rod Mounting Bracket RMB-3 [K2.0006186](#)
 - Support Rods 240mm/9.4in, Ø15mm [K2.66253.0](#)
 - 15mm LWS Rod Console [K2.65264.0](#)
 - 15mm Reduction Insert (2x) [K2.66255.0](#)



Basic Broadcast Set for Canon EOS C400

- Consists of:
- Top Plate for Canon EOS C400 [K2.0051221](#)
 - Plate for Canon EOS C400 [K2.0051262](#)
 - Broadcast Shoulder Adapter BSA-1 [K2.0043749](#)
 - 15mm LWS Rod Console [K2.65264.0](#)
 - Support Rods 240mm/9.4in, Ø15mm [K2.66253.0](#)



Pro Broadcast Set for Canon EOS C400

- includes:
- Top Plate for Canon EOS C400 [K2.0051221](#)
 - Plate for Canon EOS C400 [K2.0051262](#)
 - Broadcast Shoulder Adapter BSA-1 [K2.0043749](#)
 - Center Camera Handle CCH-4 [K2.0017270](#)
 - Side Bracket Right for Canon EOS C400 [K2.0051223](#)
 - Side Bracket Left for Canon EOS C400 [K2.0051222](#)
 - Rear Side Bracket Right for Canon EOS C400 [K2.0051224](#)
 - NATO Rail Clamp NRC-1 [K2.0047776](#)
 - NATO Rail Clamp NRC-2 [K2.0048324](#)
 - Rod Mounting Bracket RMB-3 [K2.0006186](#)
 - Support Rods 240mm/9.4in, Ø15mm [K2.66253.0](#)
 - 15mm Reduction Insert (2x) [K2.66255.0](#)
 - 15mm LWS Rod Console [K2.65264.0](#)

Parts for Canon C400



Top Plate for Canon EOS C400, [K2.0051221](#)



Plate for Canon EOS C400, [K2.0051262](#)



Side Bracket Right for Canon EOS C400 [K2.0051223](#)



Side Bracket Left for Canon EOS C400 [K2.0051222](#)



Rear Side Bracket Right for Canon EOS C400 [K2.0051224](#)

Recommended Parts for Canon C400



Viewfinder Cross Pipe, [K2.0013302](#)



Rosette Adapters, RA-6, pair, [K2.0024574](#)



EVF Bracket for Canon LM-V1/2, [K2.0015520](#) *



Cage Top Handle CTH-2, [K2.0054160](#)



Wooden Handgrip WHG-3 right, [K2.0054216](#)



Wooden Handgrip WHG-3 left, [K2.0054215](#)

* discontinued items
only as long as stock is available (single item)

NATO Rail Sets



- NATO Accessory Rail NRC-5 Set Pro, [KK.0051127](#) includes:
- [K2.0047643](#) 1x NATO Accessory Rail NAR-30
 - [K2.0047854](#) 1x NATO Accessory Rail NAR-60
 - [K2.0047631](#) 1x NATO Accessory Rail NAR-90
 - [K2.0047771](#) 1x NATO Rail Clamp NRC-5
 - [K2.0050106](#) 1x 1/4in Slide for NAR-60/90
 - [K2.0050107](#) 1x Double M4 Slide for NAR-60/90

- NATO Accessory Rail NRC-5 Set Basic, [KK.0051126](#) includes:
- [K2.0047643](#) 1x NATO Accessory Rail NAR-30
 - [K2.0047854](#) 1x NATO Accessory Rail NAR-60
 - [K2.0047631](#) 1x NATO Accessory Rail NAR-90
 - [K2.0047771](#) 1x NATO Rail Clamp NRC-5

- NATO Accessory Rail NAR-30/NRC-5 Set, [KK.0051123](#) includes:
- [K2.0047643](#) 1x NATO Accessory Rail NAR-30
 - [K2.0047771](#) 1x NATO Rail Clamp NRC-5

- NATO Accessory Rail NAR-60/NRC-5 Set, [KK.0051124](#) includes:
- [K2.0047854](#) 1x NATO Accessory Rail NAR-60
 - [K2.0047771](#) 1x NATO Rail Clamp NRC-5

- NATO Accessory Rail NAR-90/NRC-5 Set, [KK.0051125](#) includes:
- [K2.0047631](#) 1x NATO Accessory Rail NAR-90
 - [K2.0047771](#) 1x NATO Rail Clamp NRC-5

NATO Rail Parts



NATO Accessory Rail NAR-30 [K2.0047643](#)



NATO Accessory Rail NAR-60 [K2.0047854](#)



NATO Accessory Rail NAR-90 [K2.0047631](#)



3/8in Slide for NAR-60/90 [K2.0050105](#)



1/4in Slide for NAR-60/90 [K2.0050106](#)



Double M4 Slide for NAR-60/90 [K2.0050107](#)



NATO Rail Clamp NRC-1, [K2.0047776](#)



NATO Rail Clamp NRC-2, [K2.0048324](#)



NATO Rail Clamp NRC-3, [K2.0049419](#)



NATO Rail Clamp NRC-4 [K2.0047801](#)













NATO Rail Clamp NRC-5 [K2.0047771](#)



NATO Rail Clamp NRC-6 (Rosette), [K2.0054184](#)

for more compatible NATO Rail sets and parts please see Config 5.6.1

Rosette Adapters

 Rosette Adapter RA-1 (pair), K2.66174.0	 Rosette Adapter RA-2 (pair), K2.65269.0	 Rosette Adapter RA-3 (pair), K2.65268.0	 Rosette Adapter RA-4, K2.0014825	 Rosette Adapter RA-5, K2.0024563 *
 Rosette Adapter RA-6 (pair), K2.0024574	 Extension Spacer 50 mm, K2.0013615	 Rosette Extension REX-25, K2.0048040	 Rosette Extension REX-40, K2.0049430	 Rod Clamp for REX-40, K2.0048099

 **Rosette Extension REX-40 Set**
KK.0049433, Includes:
[K2.0048099](#) 1x Rod Clamp for REX-40
[K2.0049430](#) 1x Rosette Extension REX-40
[K2.66255.0](#) 1x 15mm Reduction Insert

* discontinued items
no stock available anymore

Arrihead



ARRIHEAD 2
with integrated encoders,
without encoders, [K2.43670.0](#)

Reduction Gear, [K2.34301.0](#)
Wedge Plate, K2.47171.0
Handwheel, big, K2.47001.0

Bridge Plate Sled

Bridge Plate Sled BPS-2 Set
KK.0005813, includes:



Bridge Plate Sled BPS-2
[K2.66260.0](#)

Bottom Dovetail Plate 300mm/12in
[K2.0015896](#)

Bridge Plate



Bridge Plate Set BP-8
19 mm, K2.47090.0



Bridge Plate Set BP-9
15 mm, [K2.47091.0](#)



Bridge Plate BP-8
19 mm, [K2.0031436](#)



Bridge Plate BP-9
15 mm, [K2.0031435](#)

LWS Shoulder Support



Universal Shoulder Pad
for 15mm rods USP-2,
K2.66209.0
(incl. UMB-1 and straight foam)



Universal Mounting Bracket
for 15mm rods (UMB-1)
K2.66168.0



Camera Shoulder Pad
CSP-1, [K2.0006807](#)

Support Accessories



Shoulder Belt Adapters
SBA-1, [K2.0001223](#)



Microphone Bracket Holder
MBH-1 [K2.66256.0](#)



Lightweight Bridge Support
LBS-2, [K2.66275.0](#)



Universal Bridge Support
UBS-3, [K2.0013320](#)



Rod Mounting Bracket RMB-9
[K2.0049530](#)

Quick Release HD



Quick Release Plate
QRP-1, [K2.0000399](#)

Quick Release HD



19mm Adapter for Sony F5/F55, K2.66271.0



Quick Release HD Baseplate
[K2.47796.0](#)



Support Rod Holder
19 mm, K2.47798.0
Support Rod Holder
15 mm, K2.47799.0



Bridge Plate Sled BPS-1, [K2.47797.0](#)



Bottom Plates

Bottom Plates



Bottom Dovetail Plate 150mm/6in
[K2.0020427](#)



Bottom Dovetail Plate 300mm/12in
[K2.0015896](#)

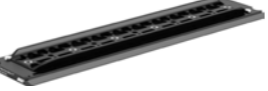

Bottom Dovetail Plate 450mm/18in
[K2.0015950](#)



Bottom Dovetail Plate 600mm/24in
[K2.0015952](#)



Rod Support Bracket RSB-15, [K2.0000437](#)
Rod Support Bracket RSB-19, [K2.0000440](#)

Lens Support



Lens Support LS-9 for 19 mm rods
[K2.47227.0](#)



Lens Support LS-10 for 15 mm rods
[K2.47228.0](#)



Lightweight Lens Support LLS-1 for 15 mm rods,
[K2.0017029](#)



Lightweight Lens Support LLS-1 Set, [KK.0047392](#)



LLS-1 Pin, [K2.0038782](#)



LLS-1 Pin Small, [K2.0047386](#)

Top Handles



Cage Top Handle CTH-1, [K2.66227.0](#)



Cage Top Handle CTH-2, [K2.0054160](#)



Lightweight Camera Handle LCH-1, [K2.0024066](#)



Camera Center Handle CCH-4, [K2.0017270](#)



Center Camera Handle CCH-2, [K2.73002.0](#)

Handle Support

Handle Extension Set, KK.0037820 includes:

- [K2.0019791](#) 1x Handle Extension HEX-1
- [K2.0019792](#) 1x Handle Extension HEX-2
- [K2.0019797](#) 1x Handle Extension HEX-3
- [K2.0019798](#) 1x Handle Extension HEX-4
- [K2.0036917](#) 1x Handle Extension HEX-5
- [K2.0019810](#) 1x Handle Extension HEX-90
- [K2.0037131](#) 1x Wooden Shell for HEX
- [K2.0037132](#) 1x Plastic Shell for HEX



Handle Extension Set for ALEXA 35, KK.0051730, includes:

- [K2.0019791](#) 1x Handle Extension HEX-1
- [K2.0019792](#) 1x Handle Extension HEX-2
- [K2.0019797](#) 1x Handle Extension HEX-3
- [K2.0019798](#) 1x Handle Extension HEX-4
- [K2.0036917](#) 1x Handle Extension HEX-5
- [K2.0019810](#) 1x Handle Extension HEX-90
- [K2.0037131](#) 1x Wooden Shell for HEX
- [K2.0049050](#) 1x Handle Extension HEX-A



Handle Extension HEX-1, [K2.0019791](#)



Handle Extension HEX-2, [K2.0019792](#)



Handle Extension HEX-3, [K2.0019797](#)



Handle Extension HEX-4, [K2.0019798](#)



Handle Extension HEX-5, [K2.0036917](#)



Handle Extension HEX-90, [K2.0019810](#)



Handle Extension HEX-A, [K2.0049050](#)



Handle Extension Block HEB-1, [K2.0001016](#)



Handle Extension Block long, HEB-3, [K2.0001017](#)



CCH-2 Support, [K2.0038176](#)



Wooden Shell for HEX [K2.0037131](#)



Plastic Shell for HEX [K2.0037132](#)



Bicycle Grip Adapter BGA-1, [K2.0034248](#)



Bicycle Grip Adapter BGA-2, [K2.0036623](#)

Handgrip Support



Rosette Extension REX-40 Set

- KK.0049433, Includes:
- [K2.0048099](#) 1x Rod Clamp for REX-40
 - [K2.0049430](#) 1x Rosette Extension REX-40
 - [K2.66255.0](#) 1x 15mm Reduction Insert



Rosette Extension REX-25, [K2.0048040](#)



Rosette Extension REX-40, [K2.0049430](#)



Rod Clamp for REX-40, [K2.0048099](#)



Extension Tube [K2.47136.0](#)



Extension Spacer 50 mm, [K2.0013615](#)



15 mm Cable Clip [K2.0012921](#)



Handgrip Extension 80 mm, [K2.0012913](#)



Handgrip Extension 160 mm, [K2.0012911](#)



Handgrip Extension 240 mm, [K2.0012917](#)

Handgrip Sets and Parts

- UBS-3 Handgrip Set** without on/off, [KK.0005675](#), includes:
- [K2.47861.0](#) 2x Handgrip without on/off switch
 - [K2.47863.0](#) 2x Handgrip Extension, long
 - [K2.0013320](#) 1x Universal Bridge Support UBS-3



- LBS-2 Handgrip Set** without on/off, [KK.0005674](#), includes:
- [K2.47861.0](#) 2x Handgrip without on/off switch
 - [K2.47863.0](#) 2x Handgrip Extension, long
 - [K2.66275.0](#) 1x Lightweight Bridge Support LBS-2



- UBS-3 Handgrip Set on/off RS 3-pin**, [KK.0005677](#), includes:
- [K2.47861.0](#) 1x Handgrip without on/off switch
 - [K2.47862.0](#) 1x Handgrip with on/off switch RS-3 pin
 - [K2.47863.0](#) 2x Handgrip Extension, long
 - [K2.0013320](#) 1x Universal Bridge Support UBS-3



- LBS-2 Handgrip Set on/off RS 3-pin**, [KK.0005676](#), includes:
- [K2.47861.0](#) 1x Handgrip without on/off switch
 - [K2.47862.0](#) 1x Handgrip with on/off switch RS-3 pin
 - [K2.47863.0](#) 2x Handgrip Extension, long
 - [K2.66275.0](#) 1x Lightweight Bridge Support LBS-2



- Handgrip Set Right**, [KK.0005710](#), includes:
- [K2.45886.0](#) 1x Standard righthand articulating Handgrip
 - [K2.47863.0](#) 1x Handgrip Extension, long



Wooden Handgrip WHG-3 right, [K2.0054216](#)



Wooden Handgrip WHG-3 left, [K2.0054215](#)



Wooden Handgrips WHG-2 (Pair) [K2.0052124](#)



Mountable Run Stop Button MRS-1, [K2.0045006](#)



Cable RRS-1 (0.8m/2.6ft) [K2.0051326](#)

Cable RS/PWR IN - LANC [K2.0049984](#)



Handgrip without on/off switch, [K2.47861.0](#)



Handgrip with on/off switch RS-3 pin, [K2.47862.0](#)



Handgrip with on/off switch Hirose 4-pin, [K2.66278.0](#)



Standard Grip Left SGL-1, [K2.0016317](#)



Standard Grip Right SGR-1, [K2.0016318](#)



Standard righthand articulating Handgrip [K2.45886.0](#)









Brackets for Rods

-  **LSA-1 Lighting Spigot Adapter**
[K2.0014833](#)
-  **Rod Mounting Bracket RMB-5**
[K2.0014827](#)
-  **Rod Mounting Bracket RMB-6**
[K2.0020163](#) *
-  **Rod Mounting Bracket RMB-6 set**
[KK.0020673](#)
-  **Multi Interface Adapter MIA-1**
K2.0014323
-  **Rod Mounting Bracket RMB-8**
[K2.0034309](#)
-  **Rod Mounting Bracket RMB-8 Set**
[KK.0037732](#)
-  **Rod Mounting Bracket RMB-2, ***
KK.0005807
-  **Dovetail Insert Rod Bracket for WHA**, K2.52150.0
-  **WHA-2 Rosette Bracket**
[K2.52153.0](#)
-  **Rod Mounting Bracket RMB-3**, K2.0006186

Adapters with Rosette

-  **Rosette Adapter RA-1 (pair)**
[K2.66174.0](#)
-  **Rosette Adapter RA-2 (pair)**
[K2.65269.0](#)
-  **Rosette Adapter RA-3 (pair)**
[K2.65268.0](#)
-  **Rosette Adapter RA-4**
[K2.0014825](#)
-  **Rosette Adapter RA-5**
[K2.0024563](#)
-  **Rosette Adapter RA-6 (pair)**
[K2.0024574](#)
-  **Extension Spacer 50 mm**
[K2.0013615](#)

19 mm Studio Rods

-  **540 mm, [K2.72028.0](#)**
stainless steel
-  **440 mm, [K2.0001022](#)**
stainless steel
-  **340 mm, [K2.66269.0](#)**
stainless steel, lightweight
-  **240 mm, [K2.66270.0](#)**
stainless steel, lightweight
-  **150 mm, [K2.0016090](#)**
stainless steel, lightweight
-  **90 mm, [K2.0016088](#)**
stainless steel, lightweight
-  **Single Support Rods 540 mm**
[K2.0014959](#), carbon fibre, black
-  **Single Support Rods 340 mm**
[K2.0014954](#), carbon fibre, black





Monitor Mounting

-  **Univ. Mounting Arm, UMA-120**
[K2.65020.0](#)
-  **Monitor Arm MMA-65**
[K2.41101.0](#)
recommended for HDM-7
-  **Univ. Mounting Arm, UMA-240**
[K2.41100.0](#)
-  **Adjustable Monitor Mount AMM-1**
[K2.0014829](#)
-  **Monitor Adapter for Transvideo**
[K2.0014831](#)
-  **Monitor Adapter for Small HD**
[K2.0014832](#)









Recorder / Battery Bracket

-  **Battery Adapter Plate BAP-1**
[K2.0006471](#)

15 mm Studio Rods

-  **540 mm, [K2.72029.0](#)**
stainless steel
-  **440 mm, [K2.0001031](#)**
stainless steel
-  **340 mm, [K2.66252.0](#)**
stainless steel, lightweight
-  **240 mm, [K2.66253.0](#)**
stainless steel, lightweight
-  **140 mm, [K2.66254.0](#)**
stainless steel, lightweight

Brackets

-  **Quick Change Adapter 3/8",** [K2.52080.0](#)
-  **Dovetail Insert, 3/8 inch thread,** [K2.52082.0](#)
-  **Dovetail Shoe, 3/8 inch thread,** [K2.52083.0](#)
-  **Microphone Holder Bracket MHB-1,** [K2.66256.0](#)
-  **L-Bracket,** [K2.0001967](#)
-  **V-Plate,** [K2.0001758](#)
-  **3/8" Thread Adapter**
[K2.0014893](#)
-  **3/8" Accessory Shoe**
[K2.54077.0](#)
-  **Shoulder Belt Adapters SBA-1,** [K2.0001223](#)

* discontinued items
only as long as stock is available (single item)

NATO Rail Sets



NATO Accessory Rail NRC-5 Set Basic, [KK.0051126](#)
includes:
[K2.0047643](#) 1x NATO Accessory Rail NAR-30
[K2.0047854](#) 1x NATO Accessory Rail NAR-60
[K2.0047631](#) 1x NATO Accessory Rail NAR-90
[K2.0047771](#) 1x NATO Rail Clamp NRC-5



NATO Accessory Rail NRC-5 Set Pro, [KK.0051127](#)
includes:
[K2.0047643](#) 1x NATO Accessory Rail NAR-30
[K2.0047854](#) 1x NATO Accessory Rail NAR-60
[K2.0047631](#) 1x NATO Accessory Rail NAR-90
[K2.0047771](#) 1x NATO Rail Clamp NRC-5
[K2.0050106](#) 1x 1/4in Slide for NAR-60/90
[K2.0050107](#) 1x Double M4 Slide for NAR-60/90



NATO Accessory Rail NAR-30/NRC-5 Set, [KK.0051123](#)
includes:
[K2.0047643](#) 1x NATO Accessory Rail NAR-30
[K2.0047771](#) 1x NATO Rail Clamp NRC-5



NATO Accessory Rail NAR-60/NRC-5 Set, [KK.0051124](#)
includes:
[K2.0047854](#) 1x NATO Accessory Rail NAR-60
[K2.0047771](#) 1x NATO Rail Clamp NRC-5



NATO Accessory Rail NAR-90/NRC-5 Set, [KK.0051125](#)
includes:
[K2.0047631](#) 1x NATO Accessory Rail NAR-90
[K2.0047771](#) 1x NATO Rail Clamp NRC-5

Articulated Mounting Plate AMP-2 Set

Articulated Mounting Plate AMP-2 Set, [KK.0053568](#), includes:
[K2.0052697](#) 1x Swivel Mechanism Bracket
[K2.0051823](#) 1x NATO Rail Bar NRB-160
K2.0048324 1x NATO Rail Clamp NRC-2



Radio Interface Adapter RIA-1, AMP-2 Set, [KK.0053569](#), includes:
[K2.0052697](#) 1x Swivel Mechanism Bracket
[K2.0051823](#) 1x NATO Rail Bar NRB-160
K2.0048324 1x NATO Rail Clamp NRC-2
[K2.0036186](#) 1x Radio Interface Adapter RIA-1

19 mm Studio Rods

 **540 mm, [K2.72028.0](#)**
stainless steel

 **440 mm, [K2.0001022](#)**
stainless steel

 **340 mm, [K2.66269.0](#)**
stainless steel, lightweight

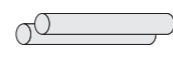
 **240 mm, [K2.66270.0](#)**
stainless steel, lightweight

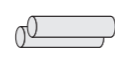
 **150 mm, [K2.0016090](#)**
stainless steel, lightweight

 **90 mm, [K2.0016088](#)**
stainless steel, lightweight

 **Single Support Rods 540 mm**
[K2.0014959](#), carbon fibre, black

 **Single Support Rods 340 mm**
[K2.0014954](#), carbon fibre, black

Components



NATO Accessory Rail NAR-30
[K2.0047643](#)



NATO Accessory Rail NAR-60
[K2.0047854](#)



NATO Rail Bar NRB-80,
[K2.0051779](#)



NATO Accessory Rail NAR-90
[K2.0047631](#)



NATO Rail Bar NRB-160
[K2.0051823](#)



Swivel Mechanism Bracket
[K2.0052697](#)



3/8in Slide for NAR-60/90
[K2.0050105](#)



1/4in Slide for NAR-60/90
[K2.0050106](#)



Double M4 Slide for NAR-60/90
[K2.0050107](#)



NATO Rail Clamp NRC-1,
[K2.0047776](#)



NATO Rail Clamp NRC-2,
K2.0048324



NATO Rail Clamp NRC-3
[K2.0049419](#)



NATO Rail Clamp NRC-4
[K2.0047801](#)



NATO Rail Clamp NRC-5
[K2.0047771](#)



NATO Rail Clamp NRC-6
(Rosette), [K2.0054184](#)

Accessory Rail System Sets**



Accessory Rail Cube
ARC-1** [K2.0033852](#)



Accessory Rail Small
ARS-1**, [K2.0016751](#)



Accessory Rail Bracket
ARB-1** [K2.0019444](#)



Accessory Rail Small
ARS-2**, [K2.0034009](#)



Accessory Rail Small
ARS-3**, [K2.0034278](#)

** discontinued items
no stock available anymore

Rod Standards (blue rods): 15mm LWS (Light Weight Support)

Configuration Overview | 5.7.0 / 2024.01

Rod Standards

VIEW INTO LENS FRONT

All dimensions in millimeters

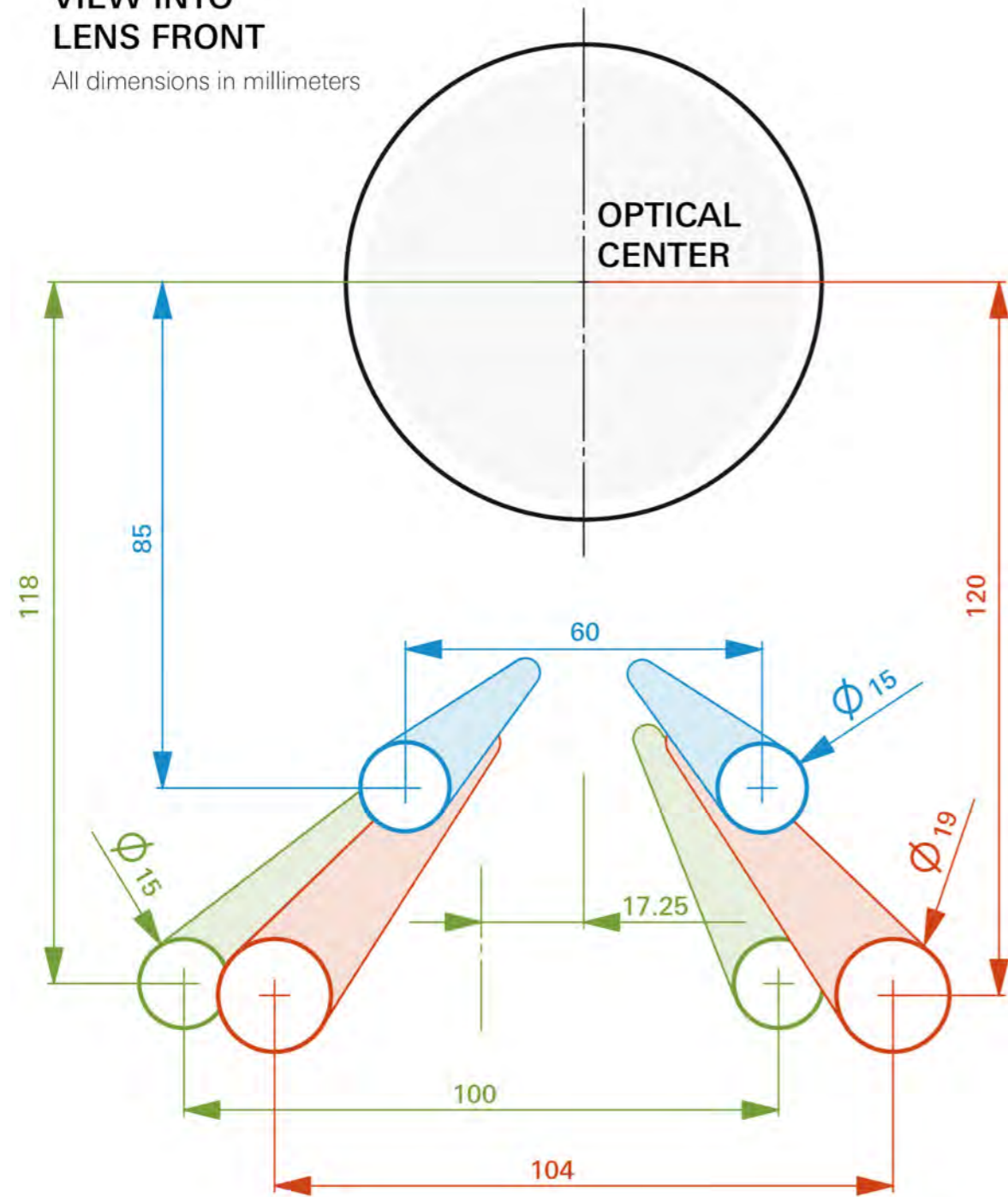

ALEXA Mini LF / ALEXA Mini



Broadcast Plate for ALEXA Mini, K2.0008509



Mini Adapter Plate MAP-2A, K2.0023839



Camera Shoulder Pad CSP-1, K2.0006807



15mm LWS Adapter for CBP, K2.0019773



Low bracket for CSP-1, K2.0008408



Battery Adapter Plate BAP-1 K2.0006471

Lens Support



Lightweight Lens Support LLS-1 for 15 mm rods, K2.0017029



LLS-1 Pin, K2.0038782



LLS-1 Lens Bridge, K2.0038783

AMIRA Camera Support



Universal Adapter Plate UAP-2 Set, K0.0001280



Universal Adapter Plate UAP-2, K2.0001221



Bridge Plate Adapter BPA-3, K2.75006.0 (compatible with BP-8)



Wedge Plate Adapter WPA-1, K2.75000.0

Matte Boxes



MMB-2



LMB 4x5



SMB-2 Matte Box ** 15mm LWS Arm, K2.0002467

** discontinued items
no stock available anymore

Follow Focus



MFF-2



FF-4



FF-5

Rod Standards (red rods): 19mm Studio Support

Configuration Overview | 5.7.1 / 2021.01

Rod Standards

VIEW INTO LENS FRONT

All dimensions in millimeters

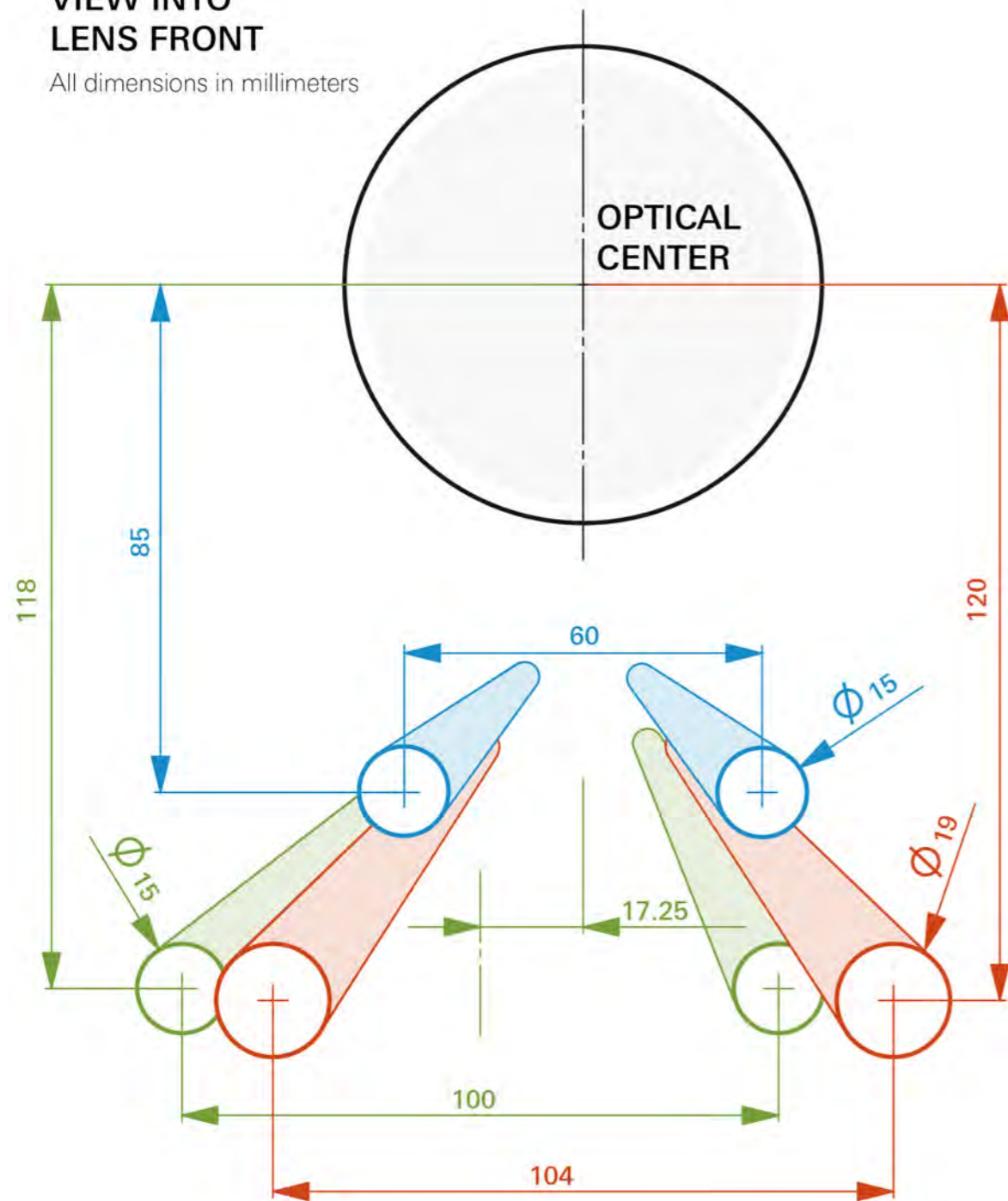

ALEXA Mini LF / ALEXA Mini



Compact Bridge Plate CBP-1
19mm for ALEXA Mini
K2.0014894

AMIRA Camera Support



Compact Bridge Plate
CBP-3 19mm for AMIRA,
K2.0019580

Bridge Plate Sets



Bridge Plate Set BP-8
19 mm, K2.47090.0



Bridge Plate Set BP-12
19 mm, KK.0005819

Lens Support - Studio



Lens Support LS-9 for 19 mm rods
K2.47227.0

Matte Boxes



LMB 4x5 / LMB 6x6
LMB 19mm Studio
Rod Adapter
K2.0013432



SMB-1 / SMB-2
Matte Box **

** discontinued items
no stock available
anymore

Quick Release HD



19mm Adapter for
Sony F5/F55, K2.66271.0



Quick Release
HD Baseplate
K2.47796.0

Support Rod Holder
19mm, K2.47798.0



Bridge Plate Sled
BPS-1, K2.47797.0

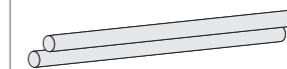

Bottom Plates



Bottom Plates



Bottom Dovetail Plate
150mm/6in, K2.0020427

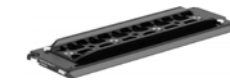

Bottom Dovetail Plate
300mm/12in, K2.0015896



Bottom Dovetail Plate
450mm/18in, K2.0015950



Bottom Dovetail Plate
600mm/24in, K2.0015952



Rod Support Bracket RSB-19, K2.0000440



Bottom Plate Set 600 mm/24"
incl. RSB-19, KK.0005685

Follow Focus



FF-4



FF-5

Rod Standards (green rods): 15mm Studio Support

Configuration Overview | 5.7.2 / 2024.01

Rod Standards

VIEW INTO LENS FRONT

All dimensions in millimeters

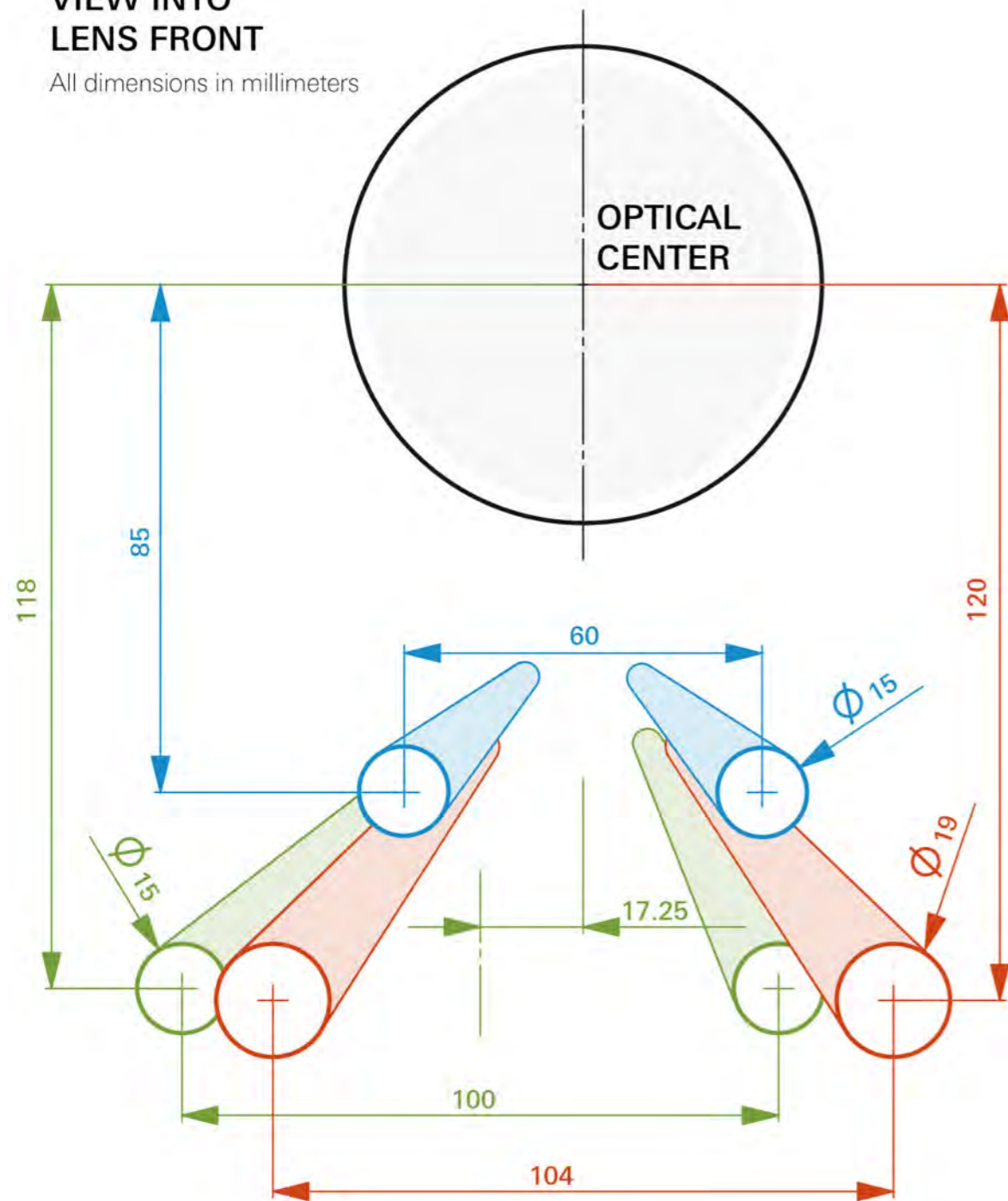

ALEXA Mini LF / ALEXA Mini



Compact Bridge Plate CBP-2
15mm for ALEXA Mini,
K2.0019441

AMIRA Camera Support



Compact Bridge Plate CBP-4
15mm for AMIRA, K2.0019582

Bridge Plate Sets



Bridge Plate Set BP-9
15 mm, [K2.47091.0](#)



Bridge Plate Set BP-13
15 mm, KK.0005771

Lens Support - Studio



Lens Support LS-10 for 15 mm rods
[K2.47228.0](#)

Matte Boxes



LMB 4x5 / LMB 6x6



SMB-1 / SMB-2
Matte Box **

** discontinued items
no stock available
anymore

Quick Release HD

Quick Release
HD Baseplate
[K2.47796.0](#)



Bridge Plate Sled
BPS-1, [K2.47797.0](#)



Support Rod Holder
15 mm, K2.47799.0

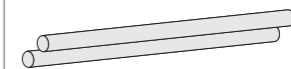

Bottom Plates



Bottom Plates



Bottom Dovetail Plate
150mm/6in, [K2.0020427](#)

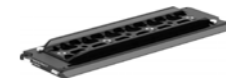

Bottom Dovetail Plate
300mm/12in, [K2.0015896](#)



Bottom Dovetail Plate
450mm/18in, [K2.0015950](#)



Bottom Dovetail Plate
600mm/24in, [K2.0015952](#)



Rod Support Bracket RSB-15
[K2.0000437](#)



Bottom Plate Set 600 mm/24"
incl. RSB-15, KK.0005684

Follow Focus



FF-4



FF-5

Mini Follow Focus MFF-2 Cine Sets

Cine: Gear Ratio 2:1



MFF-2 Cine Standard Set

Consists of:
Mini Follow Focus MFF-2 Cine,
Focus Knob Standard left,
Focus Gear 0.8/43 teeth,

[KK.0005759](#)
[K2.65255.0](#)
[K2.65253.0](#)
[K2.65259.0](#)



MFF-2 Cine Hard Stop Set

Consists of:
Mini Follow Focus MFF-2 Cine,
Focus Knob Hard Stop,
Focus Gear 0.8/43 teeth,

[KK.0005760](#)
[K2.65255.0](#)
[K2.65248.0](#)
[K2.65259.0](#)



MFF-2 Cine 2-Speed Set

Consists of:
Mini Follow Focus MFF-2 Cine,
Focus Knob 2-Speed,
Focus gear 0.8/43 teeth,

[KK.0005761](#) **
[K2.65255.0](#)
[K2.66129.0](#)
[K2.65259.0](#)



MFF-2 Cine Standard/Hard Stop Set

Consists of:
Mini Follow Focus MFF-2 Cine,
Focus Knob Standard left,
Focus Knob Hard stop,
Focus Gear 0.8/43 teeth,

[KK.0005762](#)
[K2.65255.0](#)
[K2.65253.0](#)
[K2.65248.0](#)
[K2.65259.0](#)

Mini Follow Focus MFF-2 HD Sets

HD: Gear Ratio 1:1



MFF-2 HD ENG Standard Set

Consists of:
Mini Follow Focus MFF-2 HD,
Focus Knob Standard left,
Focus Gear 0.6/64 teeth,
Focus Gear 0.5/78 teeth,

[KK.0005772](#)
[K2.65260.0](#)
[K2.65253.0](#)
[K2.47632.0](#)
[K2.47631.0](#)



MFF-2 HD ENG Hard Stop Set

Consists of:
Mini Follow Focus MFF-2 HD,
Focus Knob Hard Stop,
Focus Gear 0.6/64 teeth,
Focus Gear 0.5/78 teeth,

[KK.0005773](#) **
[K2.65260.0](#)
[K2.65248.0](#)
[K2.47632.0](#)
[K2.47631.0](#)



MFF-2 HD SLR Hard Stop Set

Consists of:
Mini Follow Focus MFF-2 HD,
Focus Knob Hard Stop,
Focus gear 0.8/43 teeth,

[KK.0005774](#)
[K2.65260.0](#)
[K2.65248.0](#)
[K2.65259.0](#)

Base and Accessories MFF-2



MFF-2 Cine, [K2.65255.0](#)
gears and knob need to
be ordered separately
gear ratio: 1:2

Flexible Shaft, short
[K2.34100.0](#) (300 mm)



MFF-2 HD, [K2.65260.0](#)
gears and knob need to
be ordered separately
gear ratio: 1:1



Flexible Shaft, long
[K2.32731.0](#) (900 mm)



Focus lever
[K2.32730.0](#)

Follow Focus Gears



Hard Stop Focus Knob
for left, [K2.65248.0](#)
(incl. 1x [K4.47621.0](#))

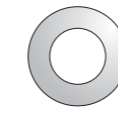

Marking Disk
bevelled, [K4.47621.0](#)
flat, [K2.47292.0](#)



Focus Knob Standard
left, [K2.65253.0](#)
(incl. 1x [K2.32701.0](#))

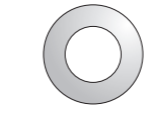

Marking disk
bevelled, [K2.47248.0](#)
flat, [K2.32701.0](#)



2-Speed Focus Knob
left, [K2.66129.0](#)
(incl. 1x [K2.32701.0](#))



Marking disk
bevelled, [K2.47248.0](#)
flat, [K2.32701.0](#)



Zip Gear cpl., [K2.66131.0](#)
incl. zoom or locking pin to equip
photo lens with a proper 0,8
gearing zooming or as a support
with LS-11 (for 15 mm rods - rods
not incl.)

Zip Gear Basic Set, [KK.0005755](#)
consists of 2 zip gears cpl.

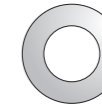

Set of Marking Disk
(10x [K2.32701.0](#)), [KK.0005768](#)

Set of Marking Disk
(5x [K2.32701.0](#)), [KK.0005769](#)



FF Gear 0.8 Mod,
35 Tooth, 10mm

Module Gear for
smaller prime lenses
and 16mm zooms
[K2.65276.0](#)



FF Gear 0.8 Mod,
35 Tooth, 25mm

Gear for lenses with axial
movement of focus ring
[K2.47557.0](#)



FF Gear 0.8 Mod,
35 Tooth, 45mm

Gear for prime lenses with
large barrels or lenses with
extending element when
pulling focus, [K2.0020132](#)



FF Gear 0.8 Mod,
43 Tooth, 45mm

Gear for zoom lenses with
large barrels or lenses with
extending element when
pulling focus, [K2.0020752](#)



FF Gear 0.8 Mod,
43 Tooth, 6mm

Module Gear
for larger prime lenses
and 35mm zooms
[K2.65259.0](#)



FF Gear 32 Dp. 14,5 PA,
35 Tooth, 10mm

Module Gear
for Panavision lenses
[K2.66055.0](#)



FF Gear 0.5 Mod,
78 Tooth, 6mm, ENG/EFP

Focus Gear 0.5 Module
for Canon ENG/EFP lenses
[K2.47631.0](#)



FF Gear 0.5 Mod,
78 Tooth, 10mm, ENG

Module Gear - wide face
for Canon and Angenieux
ENG lenses, [K2.65124.0](#)



FF Gear 0.6 Mod,
64 Tooth, 6mm ENG/EFP

Focus Gear 0.6 Module
for Fujinon ENG/EFP lenses
[K2.47632.0](#)



FF Gear 0.6 Mod,
64 Tooth, 10mm ENG

Module Gear - wide face
for Fujinon ENG lenses
[K2.65125.0](#)



FF Gear 0.8 Mod,
64 Tooth, 6mm

Gear for larger prime lenses
or for higher transmission
ratio on FF5 HD with larger
lenses, [K2.65102.0](#)



Friction gear

** discontinued items
no stock available anymore

Studio Follow Focus FF-5 System / FF-4



Configuration Overview | 6.2.0 / 2026.02

Follow Focus FF-5 Sets



FF-5 Cine Set basic
[KK.0005757](#)
 Gear Ratio 2:1
 incl.
 FF-5 Cine Base, [K2.65246.0](#)
 Focus Knob standard left, [K2.65253.0](#)
 Module gear for smaller primes 0,8, [K2.47252.0](#)
 Module gear for larger primes 0,8, [K2.65259.0](#)

FF-5 HD Set basic **
[K0.60145.0](#)
 Gear Ratio 1:1
 incl.
 FF-5 HD Base, [K2.65252.0](#)
 Focus Knob standard left, [K2.65253.0](#)
 Module gear 0,5/78/6, [K2.47631.0](#)
 Module gear 0,6/64/6, [K2.47632.0](#)

additional accessories e.g.
 Bridgeplate Adapters for
 19mm or 15mm have to
 be ordered separately

**** discontinued items
 no stock available anymore**

FF-5 Cine Set pro
[KK.0005758](#)
 Gear Ratio 2:1
 incl.
 FF-5 Cine Base, [K2.65246.0](#)
 Focus Knob standard left, [K2.65253.0](#)
 Module gear for smaller primes 0,8, [K2.47252.0](#)
 Module gear for larger primes 0,8, [K2.65259.0](#)
 Focus knob standard right, [K2.47215.0](#)
 Focus lever, [K2.32730.0](#)
 Flexible shaft short, [K2.34100.0](#)
 Marking disk flat large (10x), [K2.32701.0](#)

FF-5 HD Set pro **
[K0.60146.0](#)
 Gear Ratio 1:1
 incl.
 FF-5 HD Base, [K2.65252.0](#)
 Focus Knob standard left, [K2.65253.0](#)
 Module gear 0,5/78/6, [K2.47631.0](#)
 Module gear 0,6/64/6, [K2.47632.0](#)
 Focus knob standard right, [K2.47215.0](#)
 Focus lever, [K2.32730.0](#)
 Flexible shaft short, [K2.34100.0](#)
 Marking disk flat large (10x), [K2.32701.0](#)

Basic Units and Accessories FF-5



FF-5 HD Base **
[K2.65252.0](#)
 Gear Ratio 1:1



FF-5 Cine Base
[K2.65246.0](#)
 Gear Ratio 1:2



BP Adapter 15 mm
[K2.47630.0](#)



BP Adapter 19 mm
[K2.47629.0](#)



Focus Knob Standard left
[K2.65253.0](#)



Focus Knob Standard right
[K2.47215.0](#)



2-Speed Focus Knob left
[K2.66129.0](#)



2-Speed Focus Knob right
[K2.43702.0](#)



Hard Stop Focus Knob for left and right
[K2.65248.0](#)

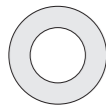

Marking Disk, flat [K2.32701.0](#)
 Marking Disk, bevelled [K2.47248.0](#)
 (for standard and 2-speed knob)



Set of Marking Disk (10x) [K2.32701.0](#), [KK.0005768](#)
 Set of Marking Disk (5x) [K2.32701.0](#), [KK.0005769](#)



Marking Disk, flat [K2.47292.0](#)
 Marking Disk, bevelled [K4.47621.0](#)
 (for hard stop knob)



Flexible Shaft long
[K2.32731.0](#)



Flexible Shaft short, [K2.34100.0](#)



Focus Lever
[K2.32730.0](#)



Coupling for Flexible Shaft
[K2.47235.0](#)



Reverse Gear Set
[KK.0005770](#)
 (incl. 1x Reverse Gear [K2.65247.0](#) & 2x Gear [K2.65259.0](#))



Extension for Focus Knob
[K2.32985.0](#)



Case for Follow Focus
[K2.44965.0](#)

Follow Focus Gears

For more Gears please see
 Configuration Overview 7.1.0



Accessories for FF-4



Focus Lever
[K2.32730.0](#)



Flexible Shaft, long
[K2.32731.0](#)
 (900 mm)



Flexible Shaft, short
[K2.34100.0](#)
 (300 mm)



Extension for focus knob
[K2.32985.0](#)



Coupling for flexible shaft
[K2.47235.0](#)
 (not for LFF-1)



Case for Follow Focus
 FF-3/FF-4, [K2.44965.0](#)



Marking Disk, bevelled
[K2.47248.0](#) (for FF-3, FF-4, FF-5HD and LFF-1 with large focus knob only)

Marking Disk, flat
[K2.32701.0](#) (for FF-3, FF-4, FF-5HD and LFF-1 with large focus knob only)

Set of Marking Disk (10x) [K2.32701.0](#)
[KK.0005768](#)
Set of Marking Disk (5x) [K2.32701.0](#)
[KK.0005769](#)

Follow Focus FF-4 black edition

BLACK edition:
Follow Focus FF-4 SET for 19 mm Rods [KK.0005745](#)
Follow Focus FF-4 SET for 15 mm Rods [KK.0005746](#)
 Set includes:
 Main Unit [K2.65221.0](#), BA Adapter [K2.65224.0](#) (19mm) or [K2.47500.0](#) (15mm), Gear for Prime lenses [K2.47252.0](#), Focus lever [K2.32730.0](#), Marking disk (4x) [K2.32701.0](#), case [K2.44965.0](#)

Sample Configuration:

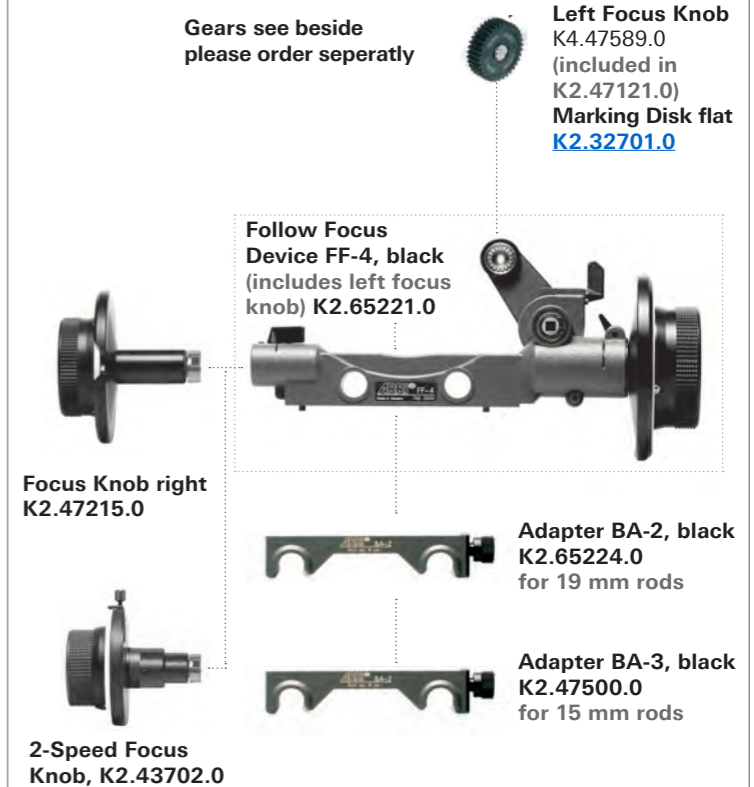

Mini Matte Box MMB-2 (4" x 5.65")



Configuration Overview | 7.1.0 / 2026.02

MMB-2 Sets



**MMB-2 Double 4"x5.65"
114 Clamp-On Set, [KK.0005764](#)**
incl.
MMB-2 basic double 4"x5.65", [K2.66169.0](#)
Combo 4" x 4"/4" x 5.65" Filter Frame,
K2.0021499



**MMB-2 Double 4"x5.65" LWS Set
[KK.0005763](#)**

incl.
MMB-2 basic double 4"x5.65", [K2.66169.0](#)
2x Combo 4" x 4"/4" x 5.65" Filter Frame,
K2.0021499
Console MMB-2, [K2.66127.0](#)
Top Flag, K2.66093.0



**MMB-2 114 Clamp-On Set
[KK.0005749](#)**

incl.
MMB-2 basic module, [K2.66124.0](#)
Filter frame 4x4/4.5" round, [K2.66128.0](#)
Combo 4" x 4"/4" x 5.65" Filter Frame,
K2.0021499



**MMB-2 Basic LWS Set
[KK.0005750](#)**

incl.
MMB-2 basic module, [K2.66124.0](#)
Filter frame 4x4/4.5" round, [K2.66128.0](#)
Combo 4" x 4"/4" x 5.65" Filter Frame,
K2.0021499
Console MMB-2, [K2.66127.0](#)
Top Flag, K2.66093.0



MMB-2 Filter Frames



**4" x 4" / 4.5" Filter Frame round
[K2.66128.0](#)**



**Combo 4" x 4"/4" x 5.65" Filter Frame,
K2.0021499**

MMB-2 Basic Module



**MMB-2 Basic Module
double 4"x5.65"
[K2.66169.0](#)**
(filter frame not incl.)



**MMB-2 Basic Module
[K2.66124.0](#)**
(filter frame not incl.)



**MMB-2 Console
[K2.66127.0](#)**

Flags

**Sideflag full Set
MMB-2
[KK.0005747](#)**

incl.
Side flag holder MMB-2, K2.66134.0 (2x)
Side flag MMB-2 right, K2.66148.0
Side flag MMB-2 left, K2.66150.0

**Sideflag Set
MMB-2
KK.0005748**

incl.
Side flag MMB-2 right, K2.66148.0
Side flag MMB-2 left, K2.66150.0



**Sideflag left
K2.66150.0**



**Sideflag right
K2.66148.0**



**Sideflag Holder
K2.66134.0**

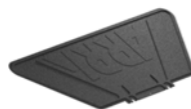

**Topflag
K2.66093.0**

MMB-2 Accessories

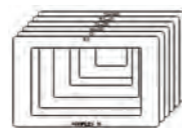

**Mattes-Set for MMB-2
[K2.66159.0](#)**



**Hand Grip Set (pair)
[K2.66135.0](#) ***



**Viewfinder Adapter
[K2.66158.0](#) ***
has one 1/4" and one
3/8" thread incl.

MMB-2 Rings



**Flexible Light Protection,
[K2.66161.0](#)
for moving zoom lenses**



Connection Ring flexible

connection ring 52, [K2.66156.0](#)
connection ring 58, [K2.66157.0](#)
connection ring 62, [K2.66154.0](#)
connection ring 67, [K2.66152.0](#) *
connection ring 72, [K2.66153.0](#)
connection ring 77, [K2.66151.0](#)
connection ring 82, [K2.66155.0](#)

**Light Protection Ring Set Pro
[KK.0005754](#)** (incl. all 7 rings & flexible light protection)

**Light Protection Ring Set Basic
[KK.0005753](#)** (incl. 3 rings 72, 77, 82 mm & flexible light protection)



Reduction / Clamp-On Ring

clamp-on ring 110 mm, [K2.66149.0](#)
clamp-on ring 104 mm, [K2.66146.0](#)
clamp-on ring 95 mm, [K2.66147.0](#)
clamp-on ring 87 mm, [K2.66190.0](#)
clamp-on ring 85 mm, [K2.0019466](#) *
clamp-on ring 80 mm, [K2.66160.0](#)

**Clamp-On Ring Set Cine
[KK.0005785](#)**

(incl. all 5 still clamp on rings,
except 114-95)



Still Lens Clamp-On Ring

clamp-on ring 52, [K2.66140.0](#)
clamp-on ring 58, [K2.66143.0](#)
clamp-on ring 62, [K2.66138.0](#)
clamp-on ring 67, [K2.66126.0](#)
clamp-on ring 72, [K2.66137.0](#)
clamp-on ring 77, [K2.66136.0](#)
clamp-on ring 82, [K2.66139.0](#)

**Still Lens Clamp-On Set Pro
[KK.0005751](#)**

(incl. all 7 still clamp on rings)

**Still Lens Clamp-On Set Basic
[KK.0005752](#)**

(incl. 3 still clamp on rings 72, 77, 82 mm)

* discontinued items
only as long as stock is available (single item)

Matte Box Checker

Find out which matte box you can use with which ARRI lens to avoid vignetting

MMB-2 System



Sets for LMB 6x6

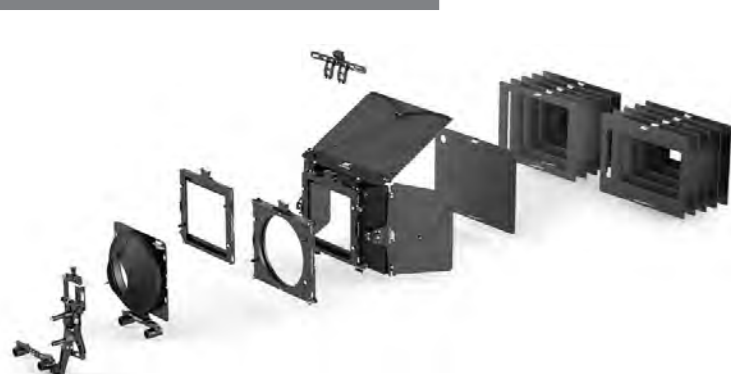

LMB 6x6 Pro 15mm Studio Set

- [KK.0020235](#) - includes:
[K2.0019218](#) 1x LMB 6x6 Basic Module
[K2.0019895](#) 1x LMB 6x6 Swing Away Tilt Mod. 15mm Studio
[K2.0013440](#) 1x LMB 15mm Studio Rod Adapter
[K2.0019085](#) 1x LMB 6x6 Tilt and Flex Adapter 80-156mm
[K2.0019159](#) 1x LMB 6x6 Extra Rotatable Filter Stage
[K2.0019133](#) 1x LMB 6x6 Extra Non-Rotatable Filter Stage
[K2.0019178](#) 1x LMB 6x6 Top, Bottom Flag
[K2.0019216](#) 1x LMB 6x6 Side Flags
[K2.0013825](#) 2x LMB Flag Holders
[K2.0013014](#) 1x LMB Accessory Adapter
[K2.0019253](#) 1x LMB 6x6 Set of Mattes spherical
[K2.0019258](#) 1x LMB 6x6 Set of Mattes anamorphic

LMB 6x6 Pro 19mm Studio Set

- [KK.0020233](#) - includes:
[K2.0019218](#) 1x LMB 6x6 Basic Module
[K2.0019083](#) 1x LMB 6x6 Swing Away Tilt Mod. 19mm Studio
[K2.0013432](#) 1x LMB 19mm Studio Rod Adapter
[K2.0019085](#) 1x LMB 6x6 Tilt and Flex Adapter 80-156mm
[K2.0019159](#) 1x LMB 6x6 Extra Rotatable Filter Stage
[K2.0019133](#) 1x LMB 6x6 Extra Non-Rotatable Filter Stage
[K2.0019178](#) 1x LMB 6x6 Top, Bottom Flag
[K2.0019216](#) 1x LMB 6x6 Side Flags
[K2.0013014](#) 1x LMB Accessory Adapter
[K2.0013825](#) 2x LMB Flag Holders
[K2.0019253](#) 1x LMB 6x6 Set of Mattes spherical
[K2.0019258](#) 1x LMB 6x6 Set of Mattes anamorphic

LMB 6x6 15mm Studio 3-Stage Set

- [KK.0020232](#) - includes:
[K2.0019218](#) 1x LMB 6x6 Basic Module
[K2.0019133](#) 1x LMB 6x6 Extra Non-Rotatable Filter Stage
[K2.0019178](#) 1x LMB 6x6 Top, Bottom Flag
[K2.0013440](#) 1x LMB 15mm Studio Rod Adapter
[K2.0019085](#) 1x LMB 6x6 Tilt and Flex Adapter 80-156mm

LMB 6x6 19mm Studio 3-Stage Set

- [KK.0020234](#) - includes:
[K2.0019218](#) 1x LMB 6x6 Basic Module
[K2.0019133](#) 1x LMB 6x6 Extra Non-Rotatable Filter Stage
[K2.0019178](#) 1x LMB 6x6 Top, Bottom Flag
[K2.0013432](#) 1x LMB 19mm Studio Rod Adapter
[K2.0019085](#) 1x LMB 6x6 Tilt and Flex Adapter 80-156mm

LMB 6x6 Clamp Adapter Set

- [KK.0020010](#) - includes:
[K2.0019156](#) 1x LMB 6x6 Clamp Adapter Ø165mm
[K2.66234.0](#) 1x LMB-6 Clamp Adapter Ø162mm
[K2.66233.0](#) 1x LMB-6 Clamp Adapter Ø156mm
[K2.0019275](#) 1x LMB 6x6 Clamp Adapter Ø143mm
[K2.66235.0](#) 1x LMB-6 Clamp Adapter Ø136mm
[K2.66236.0](#) 1x LMB-6 Clamp Adapter Ø134mm
[K2.66237.0](#) 1x LMB-6 Clamp Adapter Ø125mm
[K2.66238.0](#) 1x LMB-6 Clamp Adapter Ø114mm
[K2.66239.0](#) 1x LMB-6 Clamp Adapter Ø110mm
[K2.66240.0](#) 1x LMB-6 Clamp Adapter Ø104mm
[K2.66241.0](#) 1x LMB-6 Clamp Adapter Ø95mm

LMB 6x6 Set of Mattes spherical, [K2.0019253](#)



LMB 6x6 Set of Mattes anamorphic, [K2.0019258](#)



LMB 6x6 Clamp On 3-Stage Set

- [KK.0020231](#) - includes:
[K2.0019218](#) 1x LMB 6x6 Basic Module
[K2.0019133](#) 1x LMB 6x6 Extra Non-Rotatable Filter Stage
[K2.0019178](#) 1x LMB 6x6 Top, Bottom Flag
[K2.0023162](#) 1x LMB 6x6 Foam Insert

Clamp Adapter for LMB 6x6

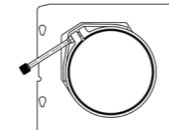

LMB 6x6 Clamp Adapter
 ø 165mm, [K2.0019156](#)

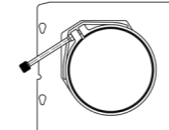

LMB 6x6 Clamp Adapter
 ø 162 mm, [K2.0019086](#)

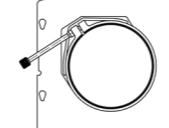

LMB 6x6 Clamp Adapter
 ø 156 mm, [K2.0019115](#)

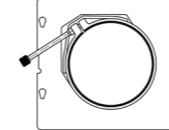

LMB 6x6 Clamp Adapter
 ø 143 mm, [K2.0019275](#)

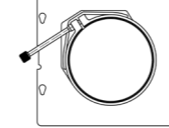

LMB 6x6 Clamp Adapter
 ø 136 mm, [K2.0019122](#)

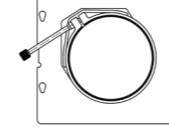

LMB 6x6 Clamp Adapter
 ø 134 mm, [K2.0019129](#)

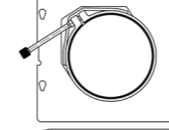

LMB 6x6 Clamp Adapter
 ø 125 mm, [K2.0019135](#)

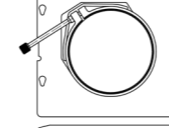

LMB 6x6 Clamp Adapter
 ø 114 mm, [K2.0019140](#)

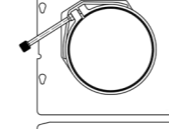

LMB 6x6 Clamp Adapter
 ø 110 mm, [K2.0019150](#)

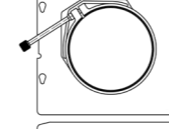

LMB 6x6 Clamp Adapter
 ø 104 mm, [K2.0019152](#)

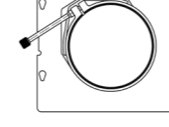

LMB 6x6 Clamp Adapter
 ø 95 mm, [K2.0019157](#)

**CAUTION: RINGS CAN VIGNETTE.
 PLEASE CONTACT ARRI.**

Accessories for LMB 6x6



LMB 6x6 Basic Module
[K2.0019218](#)



LMB 6x6 Side Flags
[K2.0019216](#)



LMB 6x6 Top Bottom Flag
[K2.0019178](#)



Diopter Frame 6"
[K2.0021310](#)



LMB 6x6 Extra Non-Rotatable Filter Stage
[K2.0019133](#)



LMB 6x6 Extra Rotatable Filter Stage,
[K2.0019159](#)



LMB 6x6 Swing way Tilt Module
 15mm Studio, [K2.0019895](#)
 19mm Studio, [K2.0019083](#)



LMB 19mm Studio Rod Adapter
[K2.0013432](#)



LMB 15mm Studio Rod Adapter
[K2.0013440](#)



Reducer Frame 6.6x6.6 to 4x5.65"
[K2.66038.0](#)



Filter Frame 6.6"x 6.6"
[K2.0033481](#)



LMB 6x6 Tilt and Flex Adapter 80-156mm
[K2.0019085](#)



LMB Flag Holders
[K2.0013825](#)



LMB Accessory Adapter
[K2.0013014](#)



LMB 6x6 Foam Insert
[K2.0023162](#)

Matte Box Checker

Find out which matte box you can use with which ARRI lens to avoid vignetting

LMB 6x6 technical data:
 Max number filters: up to three 6.6"x6.6 filters

- LMB 6x6 advanced features:
- For 6.6"x6.6 filter size
 - One product covering a wide range of applications
 - Offers quick and easy set up without tools
 - Lightweight and streamlined

Sets for LMB 4x5

LMB 4x5 Pro Set

[KK.0015177](#) - includes:
 K2.0007992 1x LMB-25 / MB-19 Set of Mattes anam.
 K2.0000069 1x LMB-25 Set of Mattes
[K2.0014206](#) 1x LMB 4x5 Tilt and Flex Adapter
[K2.0013825](#) 2x LMB 4x5 Flag Holders
[K2.0013750](#) 1x LMB 4x5 Side Flags
[K2.0013724](#) 1x LMB 4x5 Top Bottom Flag
[K2.0013447](#) 1x LMB 4x5 Swing Away Tilt Module
[K2.0014006](#) 1x LMB 4x5 Extra Non-Rotatable Filter Stage
[K2.0013460](#) 1x LMB 4x5 Extra Rotatable Filter Stage
[K2.0013014](#) 1x LMB Accessory Adapter
[K2.0013427](#) 1x LMB 4x5 15 mm LWS Console
[K2.0013589](#) 1x LMB 4x5 Basic Module (including tray catcher, filter frames and protection matte)
Note: Please order Studio Rod Adapters 15mm or 19mm separately

LMB 4x5 Clamp-On Set 3-stage

[KK.0015175](#) - includes:
[K2.0013724](#) 1x LMB 4x5 Top Bottom Flag
[K2.0014006](#) 1x LMB 4x5 Extra Non-Rotatable Filter Stage
[K2.0013589](#) 1x LMB 4x5 Basic Module (including tray catcher, filter frames and protection matte)
Note: Please order clamp adapters separately

LMB 4x5 15mm Lightweight Support (LWS) Set 3-stage

[KK.0015176](#) - includes:
[K2.0013724](#) 1x LMB 4x5 Top Bottom Flag
[K2.0014206](#) 1x LMB 4x5 Tilt and Flex Adapter
[K2.0014006](#) 1x LMB 4x5 Extra Non-Rotatable Filter Stage
[K2.0013427](#) 1x LMB 4x5 15 mm LWS Console
[K2.0013589](#) 1x LMB 4x5 Basic Module (including tray catcher, filter frames and protection matte)

Upgrade Set LMB-25 to LMB 4x5 basic

[KK.0015178](#) - includes:
 K2.0015140 1x LMB 4x5 Backplate with Filter Guides (including protection matte)
[K2.0013825](#) 1x LMB 4x5 Flag Holders

Flexible Sunshade Side Flag Holders Set,

[KK.0038066](#), includes:
[K2.0033772](#) 1x Flexible Sunshade LMB 4x5
 K2.0036441 1x LMB Side Flag Holders

Pro Set Diopter Accessory 138mm/4,5 inch

[KK.0021007](#) - includes:
[K2.0013740](#) 3x Diopter Frame 138mm
[K2.0014745](#) 1x Diopter Stage 138mm
[K2.0014357](#) 1x Diopter Adapter 138mm to 4.5in
 K2.0020158 3x Pouch Rota Pola 4x5/Diopter Frame 138
 K2.0020157 1x Pouch Diopter Stage 138

Upgrade Set LMB-25 to LMB 4x5 Pro

[KK.0015181](#) - includes:
 K2.0015140 1x LMB 4x5 Backplate wit Filter Guides (including protection matte)
[K2.0014206](#) 1x LMB 4x5 Tilt and Flex Adapter
[K2.0013825](#) 1x LMB 4x5 Flag Holders
[K2.0013750](#) 1x LMB 4x5 Side Flags
[K2.0013724](#) 2x LMB 4x5 Top Bottom Flag
[K2.0013447](#) 1x LMB 4x5 Swing Away Tilt Module
[K2.0014006](#) 1x LMB 4x5 Extra Non-Rotatable Filter Stage
[K2.0013460](#) 1x LMB 4x5 Rotatable Filter Stage
[K2.0013014](#) 1x LMB Accessory Adapter
[K2.0013427](#) 1x LMB 4x5 15 mm LWS Console
Note: Please order Studio Rod Adapters 15mm or 19mm separately

LMB 4x5 Clamp Adapter Set

[KK.0015133](#) - includes:
[K2.0014376](#) 1x LMB 4x5 Clamp Adapter Ø 80mm
[K2.0015065](#) 1x LMB 4x5 Clamp Adapter Ø 85mm
[K2.0014227](#) 1x LMB 4x5 Clamp Adapter Ø 87mm
[K2.0014439](#) 1x LMB 4x5 Clamp Adapter Ø 95mm
[K2.0015103](#) 1x LMB 4x5 Clamp Adapter Ø 100mm
[K2.0014422](#) 1x LMB 4x5 Clamp Adapter Ø 104mm
[K2.0014409](#) 1x LMB 4x5 Clamp Adapter Ø 110mm
[K2.0014396](#) 1x LMB 4x5 Clamp Adapter Ø 114mm
[K2.0014377](#) 1x LMB 4x5 Clamp Adapter Ø 125mm
[K2.0014359](#) 1x LMB 4x5 Clamp Adapter Ø 134mm
[K2.0014348](#) 1x LMB 4x5 Clamp Adapter Ø 136mm
[K2.0014168](#) 1x LMB 4x5 Clamp Adapter Ø 143mm
 (interface for LMB 4x5 15 mm LWS Console
[K2.0013427](#) integrated)
[K2.0015075](#) 1x LMB 4x5 Clamp Adapter Ø 162mm

for more Clamp Adapter Sets please see website, price list or contact your dealer

Clamp Adapter for LMB 4x5

CAUTION: Clamp-Adapter CAN VIGNETTE.

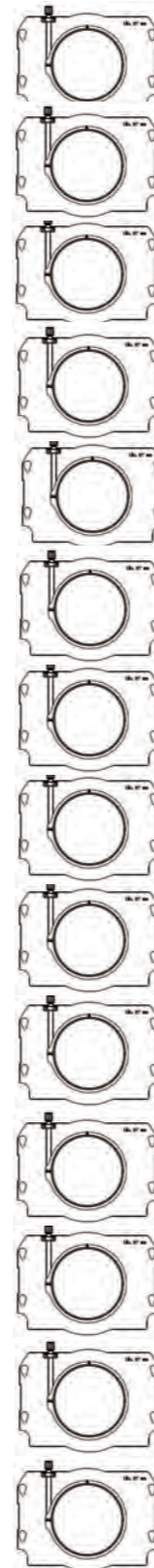

LMB 4x5 Clamp Adapter
 ø 162mm, [K2.0015075](#)

LMB 4x5 Clamp Adapter
 ø 156mm, [K2.0039254](#)

LMB 4x5 Clamp Adapter
 ø 143mm, [K2.0014168](#)

LMB 4x5 Clamp Adapter
 ø 136mm, [K2.0014348](#)

LMB 4x5 Clamp Adapter
 ø 134mm, [K2.0014359](#)

LMB 4x5 Clamp Adapter
 ø 125mm, [K2.0014377](#)

LMB 4x5 Clamp Adapter
 ø 114mm, [K2.0014396](#)

LMB 4x5 Clamp Adapter
 ø 110mm, [K2.0014409](#)

LMB 4x5 Clamp Adapter
 ø 104mm, [K2.0014422](#)

LMB 4x5 Clamp Adapter
 ø 100mm, [K2.0015103](#)

LMB 4x5 Clamp Adapter
 ø 95mm, [K2.0014439](#)

LMB 4x5 Clamp Adapter
 ø 87mm, [K2.0014227](#)

LMB 4x5 Clamp Adapter
 ø 85mm, [K2.0015065](#)

LMB 4x5 Clamp Adapter
 ø 80mm, [K2.0014376](#)

Accessories for LMB 4x5



LMB 4x5 Basic Module, [K2.0013589](#)

Flexible Sunshade LMB 4x5, [K2.0033772](#)

LMB 4x5 Side Flags, [K2.0013750](#)

LMB 4x5 Top Bottom Flag, [K2.0013724](#)



LMB 4x5 Extra Non-Rotatable Filter Stage [K2.0014006](#)

LMB 4x5 Rotatable Filter Stage, [K2.0013460](#)

LMB 4x5 Swing Away Tilt Module [K2.0013447](#)

Filter Frame 4"x 4" [K2.0015551](#)



LMB 4x5 19 mm Studio Rod Adapter [K2.0013432](#)

LMB 4x5 15 mm Studio Rod Adapter [K2.0013440](#)

LMB 4x5 15 mm LWS Console [K2.0013427](#)

LMB 4x5 Tilt and Flex Adapter [K2.0014206](#)



Diopter Frame 138 mm [K2.0013740](#)

Diopter Adapter 138 mm to 4.5" [K2.0014357](#)

Diopter Stage 138mm [K2.0014745](#)

Rota Pola Frame [K2.0009434](#)

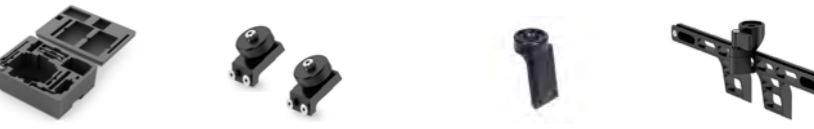

LMB 4x5 Foam Insert [K2.0023149](#)

LMB 4x5 Flag Holders [K2.0013825](#)

3/8" Accessory Shoe [K2.66178.0](#)

LMB Accessory Adapter [K2.0013014](#)

Matte Box Checker

Find out which matte box you can use with which ARRI lens to avoid vignetting

LMB 4x5 technical data:

Max number filters: up to three 4"x5.65" or 4"x4" filters

LMB 4x5 advanced features:

- One product covering a wide range of applications
- Clamp-on, 15mm lightweight and 15 and 19mm Studio Rod Support Options
- Offers quick and easy set up without tools
- Tilting option
- Safety gear such as a tray catcher and securing loop
- Accessory mount for ultrasonic or other devices
- Removable sunshade with captive screws

Accessories for LMB 6x6 & LMB 4x5



Configuration Overview | 7.3.1 / 2024.11

Accessories for LMB 6x6



LMB 6x6 Basic Module
[K2.0019218](#)



LMB 6x6 Swing way Tilt Module
15mm Studio, [K2.0019895](#)
19mm Studio, [K2.0019083](#)



LMB 6x6 Tilt and Flex Adapter 80-156mm,
[K2.0019085](#)



LMB 6x6 Side Flags
[K2.0019216](#)



LMB 6x6 Top Bottom Flag
[K2.0019178](#)



Diopter Frame 6"
[K2.0021310](#)



Diopter Stage 6"
[K2.0021332](#)



Diopter Adapter 6" to 138mm
[K2.0021298](#)



LMB 6x6 Extra Non-Rotatable Filter Stage,
[K2.0019133](#)



LMB 6x6 Extra Rotatable Filter Stage,
[K2.0019159](#)



Reducer Frame 6.6X6.6 to 4x5.65",
[K2.66038.0](#)



Filter Frame 6.6"x 6.6"
[K2.0033481](#)



LMB 6x6 Set of Mattes spherical,
[K2.0019253](#)



LMB 6x6 Set of Mattes anamorphic,
[K2.0019258](#)



LMB 6x6 Foam Insert
[K2.0023162](#)

Accessories for LMB 4x5



LMB 4x5 Basic Module
[K2.0013589](#)



LMB 4x5 Swing Away Tilt Module
[K2.0013447](#)



LMB 4x5 15 mm LWS Console
[K2.0013427](#)



LMB 4x5 Side Flags
[K2.0013750](#)

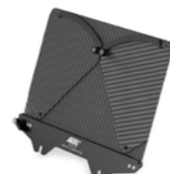

LMB 4x5 Top Bottom Flag,
[K2.0013724](#)



LMB 4x5 Tilt and Flex Adapter,
[K2.0014206](#)



Diopter Frame 138 mm,
[K2.0013740](#)



Diopter Adapter 138 mm to 4.5"
[K2.0014357](#)



Diopter Stage 138mm
[K2.0014745](#)



LMB 4x5 Extra Non-Rotatable Filter Stage
[K2.0014006](#)



LMB 4x5 Rotatable Filter Stage,
[K2.0013460](#)

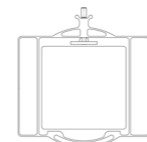

Filter Frame 4"x 4"
[K2.0015551](#)



Rota Pola Frame
[K2.0009434](#)



LMB 4x5 Foam Insert
[K2.0023149](#)



Flexible Sunshade Side Flag Holders Set,
[KK.0038066](#), includes:
[K2.0033772](#) 1x Flexible Sunshade LMB 4x5
[K2.0036441](#) 1x LMB Side Flag Holders

Accessories for LMB 6x6 & LMB 4x5



LMB 19mm Studio Rod Adapter
[K2.0013432](#)



LMB 15mm Studio Rod Adapter
[K2.0013440](#)



3/8" Accessory Shoe,
[K2.66178.0](#)



LMB 4x5 Flag Holders
[K2.0013825](#)



Accessory Rail Cube ARC-1,
[K2.0033852](#)



LMB Accessory Adapter
[K2.0013014](#)



LMB 4x5 / LMB-6 Tray Catcher
[K2.66202.0](#)

Configuration Overview | 7.8.0 / 2021.01

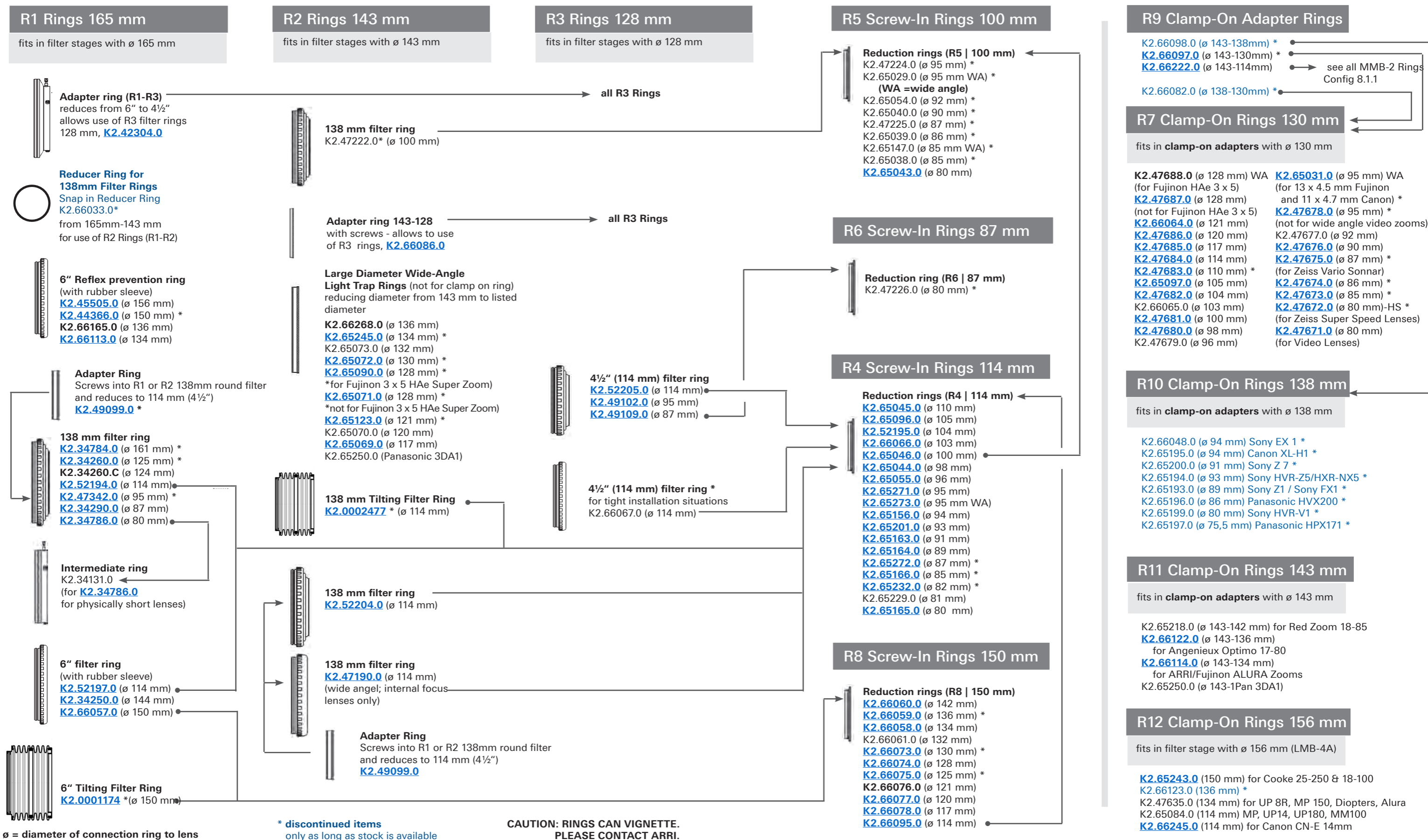

F1 Filter Frames

use for SMB-1, MB-14, MB-28, LMB-4A, LMB-6, LMB 6x6

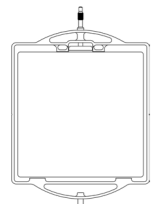

Anti Reflection Filter Frame 6.6"x6.6", non geared, [K2.0008125](#) *

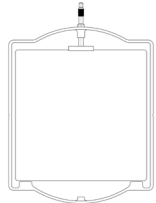

Triple Filter Frame 6.6"x6.6", non geared [K2.0005906](#)

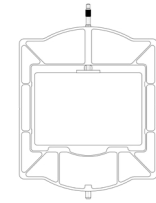

Filter Frame 4"x5.65" non geared [K2.0005874](#) *

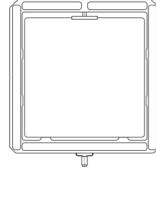

Filter Frame 5.65"x5.65" non geared, [K2.66063.0](#)
to be used with SMB-1/MB-14 / MB-28 Stages
(for Stage K2.422993.0 use F6)
MB-28 Filter Stage K2.66031.0
(for Stage K2.66032.0 use F5)

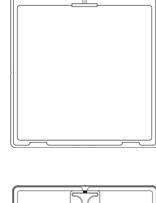

Filter Frame 6.6"x 6.6" [K2.0033481](#)



Reducer Frame from 6.6"x6.6" to 4"x5.65" for horizontal or vertical use [K2.66038.0](#)

F2 Filter Frames

use for SMB-2, MB-18

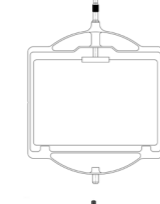

Triple Filter Frame 4"x5.65", non geared [K2.0006085](#) * only for SMB-2

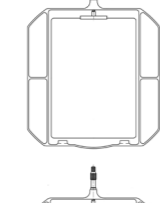

Filter Frame 4"x5.65" non geared, vertical [K2.47814.0](#) *

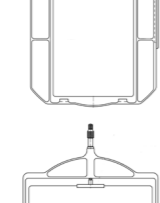

Filter Frame 4"x5.65" geared, vertical [K2.47815.0](#) *

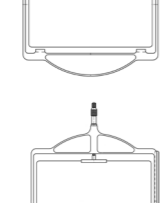

Filter Frame 4"x5.65" non geared, horizontal [K2.49083.0](#)

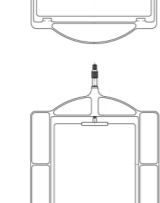

Filter Frame 4"x5.65" geared, horizontal [K2.49096.0](#) *

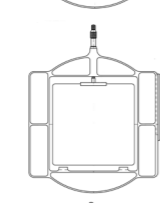

Filter Frame 4"x4" non geared [K2.47185.0](#)

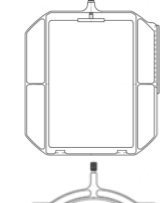

Filter Frame 4"x4" geared [K2.47186.0](#)



Filter Frame 4"x6" geared [K2.49027.0](#)

Filter Frame round for 138mm [K2.49023.0](#) *

F4 Filter Frames

use for MMB-1, MMB-2, LMB-25, MB-29

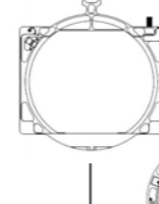

Diopter Frame 138 mm, [K2.0013740](#) only compatible with LMB-5,15,25 and 4x5

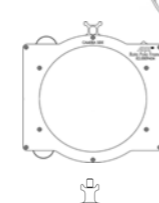

Diopter Adapter 138 mm to 4.5" [K2.0014357](#)



Rota Pola Frame [K2.0009434](#)

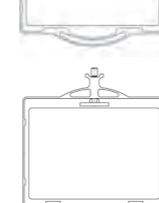

Anti Reflection Frame ARF-2 for 4"x5.65", non geared, [K2.0047475](#) only for LMB-25/LMB 4x5

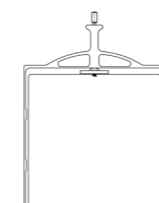

Filter Frame 4"x5.65"/4"x4" [K2.0021499](#) (LMB)

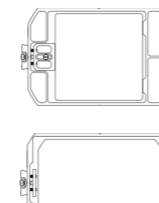

Filter Frame Combo 4"x5.65"/4"x4" [K2.66133.0](#)

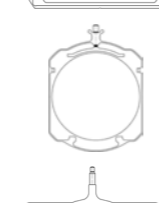

Filter Frame 5.65"x5.65" [K2.66036.0](#)



Filter Frame 4"x4" for MMB-1 side load, [K2.66072.0](#)

Filter Frame 4"x5.65" with closed corners for MMB-1 side load, , [K2.66053.0](#)

Filter Frame Combo 4"x4"/ 4.5" round for MMB-2 Basic [K2.66128.0](#)

Filter Frame 4"x4" [K2.47104.0](#) (phase out)

F4 Filter Frames

use for MMB-1, MMB-2, LMB-25, MB-29

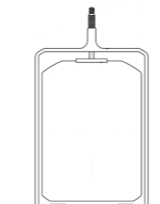

Filter Frame 4"x5.65 " vertical (for MB-19, MB-29) [K4.47493.0](#) * [K2.0001035](#) *

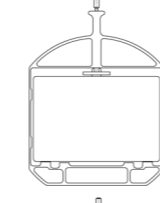

Filter Frame Combo 4"x5.65/4"x4" [K2.65230.0](#)

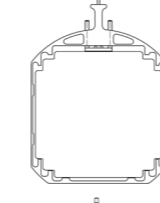

Filter Frame Combo 4"x5.65/5"x5" [K2.66037.0](#) *

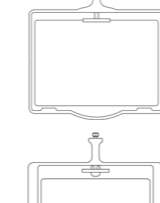

Filter Frame 4"x5.65" [K2.47669.0](#)

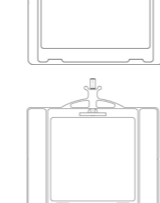

Filter Frame 5"x5" [K2.65183.0](#)

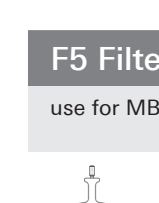

Filter Frame 4"x 4" [K2.0015551](#)

F5 Filter Frames

use for MB-20 / MB-28 Stage K2.66032.0

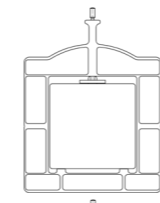

Filter Frame 4"x4" [K2.65098.0](#) (phase out)

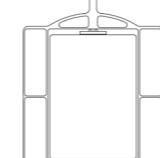

Filter Frame 4"x5.65" vertical, [K2.65049.0](#)

F5 Filter Frames

use for MB-20 / MB-28 Stage K2.66032.0

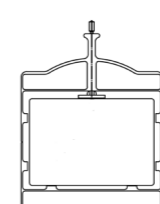

Filter Frame 4"x5.65" horizontal, [K2.65048.0](#) *

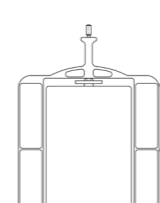

Filter Frame 4"x6" vertical, [K2.66023.0](#)

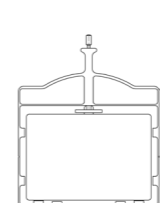

Filter Frame Combo 4"x5.65"/4"x4" horizontal, [K2.65095.0](#) *

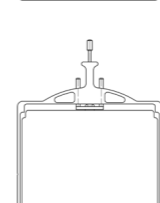

Filter Frame Combo 5.65"x5.65"/5"x6" horizontal, [K2.65022.0](#)

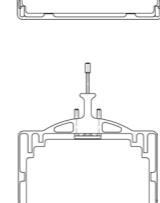

Filter Frame Combo 4"x5.65"/5"x5" [K2.65023.0](#) *

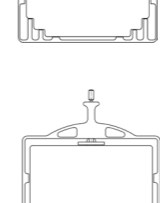

Filter Frame Combo 5.65"x5.65"/4"x5.65" vertical, [K2.65148.0](#)

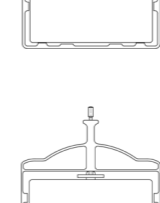

Filter Frame 4"x5.65" for 16x9 Wide-Angle [K2.66005.0](#)

ARRI FSND Filter 6.6" x 6.6"

Pouch included visit website for more details



[ARRI FSND 0.3 Filter 6.6" x 6.6"](#) [K2.0013892](#)
[ARRI FSND 0.6 Filter 6.6" x 6.6"](#) [K2.0013894](#)
[ARRI FSND 0.9 Filter 6.6" x 6.6"](#) [K2.0013896](#)
[ARRI FSND 1.2 Filter 6.6" x 6.6"](#) [K2.0013898](#)
[ARRI FSND 1.5 Filter 6.6" x 6.6"](#) [K2.0013900](#)
[ARRI FSND 1.8 Filter 6.6" x 6.6"](#) [K2.0013902](#)
[ARRI FSND 2.1 Filter 6.6" x 6.6"](#) [K2.0013905](#)
[ARRI FSND 2.4 Filter 6.6" x 6.6"](#) [K2.0013906](#)

ARRI FSND Filter 4" x 5.65"

Pouch included visit website for more details



[ARRI FSND 0.3 Filter 4" x 5.65"](#) [K2.0013887](#)
[ARRI FSND 0.6 Filter 4" x 5.65"](#) [K2.0013901](#)
[ARRI FSND 0.9 Filter 4" x 5.65"](#) [K2.0013895](#)
[ARRI FSND 1.2 Filter 4" x 5.65"](#) [K2.0013904](#)
[ARRI FSND 1.5 Filter 4" x 5.65"](#) [K2.0013897](#)
[ARRI FSND 1.8 Filter 4" x 5.65"](#) [K2.0013890](#)
[ARRI FSND 2.1 Filter 4" x 5.65"](#) [K2.0013903](#)
[ARRI FSND 2.4 Filter 4" x 5.65"](#) [K2.0013891](#)

* discontinued items only as long as stock is available

ARTEMIS & TRINITY - Upgrade Sets Options



Configuration Overview | 8.0.0 / 2024.11

Upgrade paths for different Systems

Only the following upgrade paths are currently available

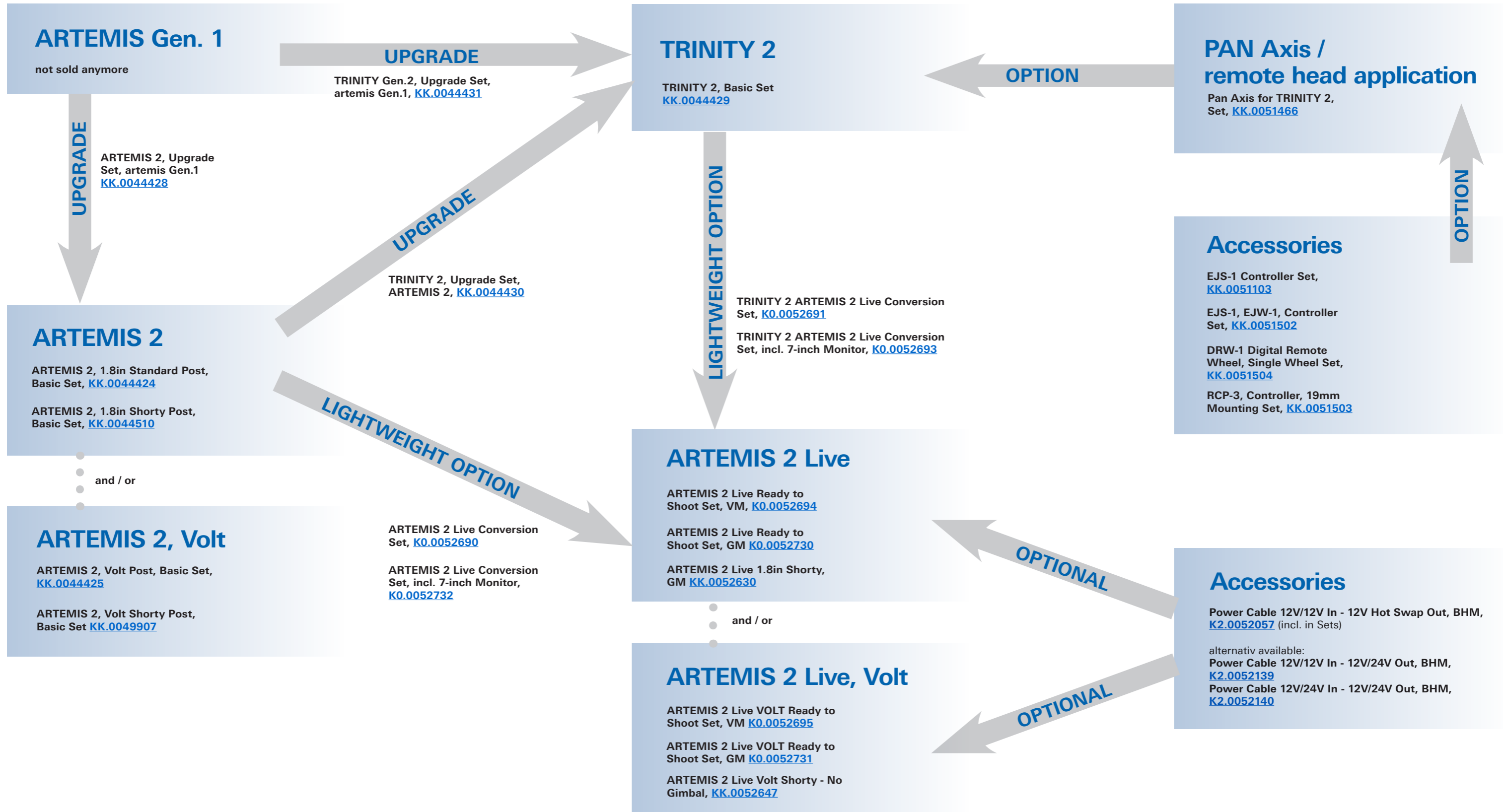

TRINITY Live & Stabilized Remote Head - Upgrade Sets Options



Configuration Overview | 8.0.1 / 2024.10

TRINITY 1 -> TRINITY Live - Upgrade Sets Options

TRINITY 1 to TRINITY 2: no upgrade available

TRINITY 1

not sold anymore

OPTION

TRINITY 1, 24V

24V Upgrade for TRINITY Gen. 1, [K2.0024710](#)

TRINITY Live Upgrade Set Basic, [KK.0044512](#)

Variant 1:

An Owner Operator wants to upgrade his own system to TRINITY Live. In this case, the Owner Operator contacts the ARRI Service in his region. It can then be decided on site whether the conversion will be carried out locally or at ARRI Service in Munich. The conversion takes two days, including all necessary tests and, if necessary, additional time for shipping.

Variant 2:

An operator who wanted to buy a TRINITY Live was offered a used TRINITY Gen. 1 by another owner. In this case, ARRI Service offers you a pre-check for the device to be sold. This way, the new customer can be sure that the purchase of the used system is worthwhile and that the conversion to TRINITY Live is feasible. Tools and the necessary training are available to the service staff in the regions from Q1 2024 for this pre-check.
Plus possible costs for other necessary ARRI services.

24V Upgrade for TRINITY Live (Gen.1), [KK.0050214](#)

Variant 1 and 2 plus possible costs for other necessary ARRI services.

This 24 V upgrade for TRINITY Live allows the system to provide reliable 24 V camera power when operators need to fly an ALEXA Mini LF, ALEXA 35, or Sony Venice. TRINITY Gen.1 rigs previously upgraded to 24 V must still be fitted with this new 24 V upgrade

Master Grip TRINITY 1 Pro Set, [KK.0049712](#)

If this function is to be part of a TRINITY Live upgrade, it must be ordered at the same time as the actual upgrade. This is the only way to avoid unnecessary costs.

This upgrade gives operators simultaneous control of a zoom lens and the stabilizer's tilt axis via a common LBUS controller. The Zoom will be controlled by the LCUBE CUB-2 or by a c-force mini motor.

Required Accessory Sets

Tally Set for TRINITY Gen.1, 3pin Lemo, [K0.0044682](#)

The TALLY Gen.2 is required to integrate the TRINITY Live into any Multicam application.

CCP Live Camera Control Panel Live Set, [KK.0047755](#)

The CCP Live is based on the CCP-1 and has been expanded to include an HDMI down converter, an HD SDI video out socket and a Tally out socket. This allows the operator to get a direct monitor video feed from the camera even when both video outputs are used for 2 x 6G video. The additional 1080 HD SDI video signal allows a control monitor to be connected to the camera if both video out sockets are already in use. If the camera is integrated into a multi-cam setup, the Tally Gen. 2 system can be controlled via the Tally Out socket.

TRINITY Live

sold only via CPO

Stabilized Remote Head - Upgrade Sets Options

Only the following upgrade paths are currently available

SRH-360

not sold anymore

360 EVO Upgrade for SRH-360, [KK.0050638](#)

UPGRADE

EVO-360

360 EVO Basic Set, No Joystick
[KK.0050103](#)

SRH-3

not sold anymore

360 EVO Upgrade for SRH-3, [KK.0050639](#)

UPGRADE

ARTEMIS 2 Overview



Gimbal Handle Extender for 1.8in Gimbal, [K2.0010569](#)

↓

ARTEMIS Gimbal, Ø1.8in, [K2.0010493](#)

ARTEMIS Carbon Center Post, Ø1.8in, [K2.0010489](#)

ARTEMIS Carbon Center Post, Ø1.8in, Short, No Main Cable, [K2.0041474](#)

ARTEMIS Super Post, Gen.2, 1.8in, 3B, 16-pin, [KK.0041404](#)

Carbon Center Post, Volt Gimbal, Pro Set, [K0.0048623](#)

ARTEMIS 2, Volt Shorty Post, Basic Set, [KK.0049907](#)



ARTEMIS Post Extension, 1.8in, 3B, length 8.5in, 16-pin, [K2.0041976](#)

Battery Mounting Base & different versions of battery mounts please see also Config 8.3.0

Hinge for Battery Hanger Module, Gen.2, Ø19mm, [K2.0037757](#)



SET: Battery Hanger Gen. 2, incl. Ø19mm Rods, [K0.0044360](#)

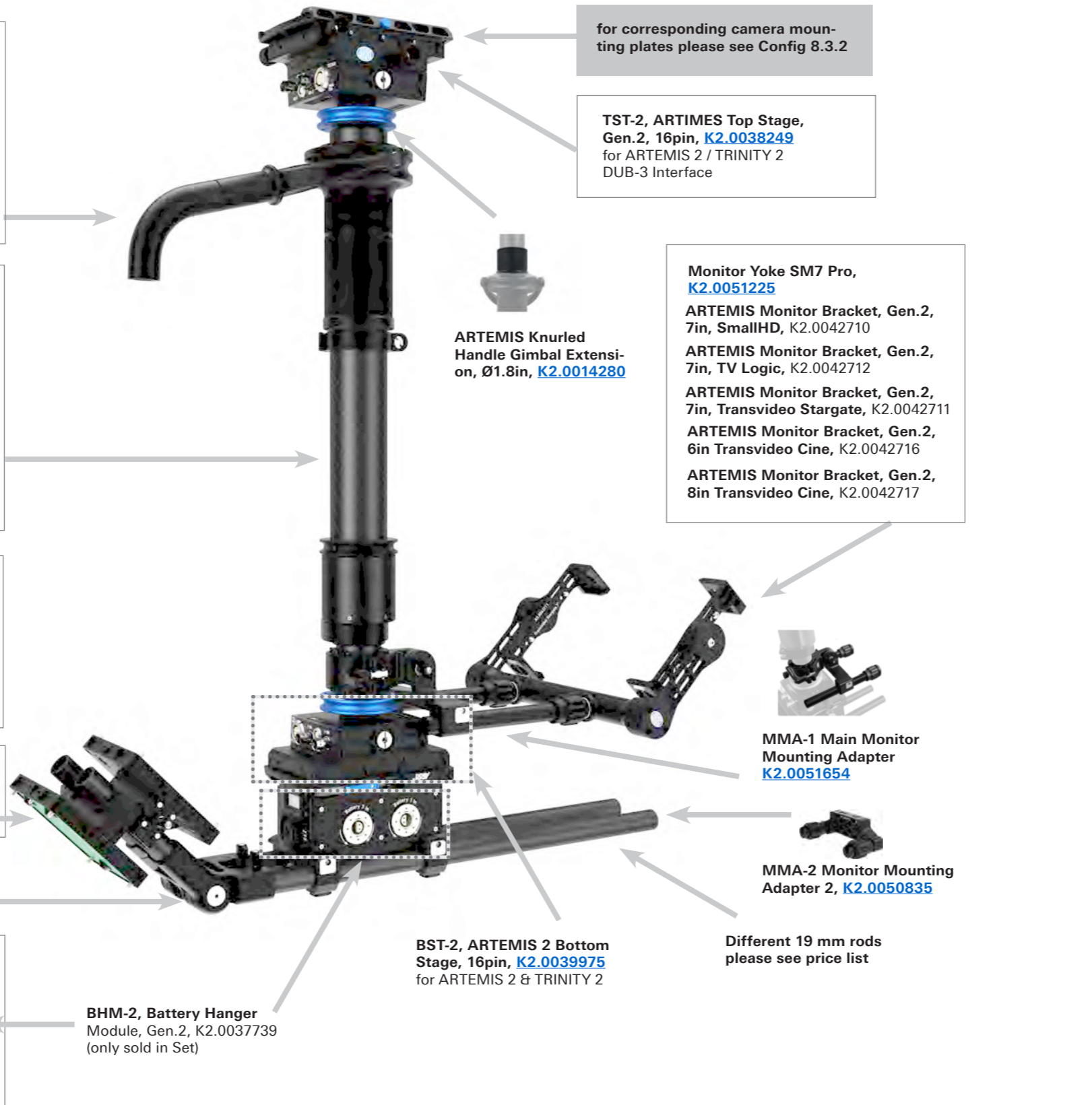

ARTEMIS Arm Sets and Vest



SmartSystem ArmX1, [K2.0054618](#)
For TRINITY 2, ARTEMIS, 2
Artemis 2 Live



SmartSystem ArmX1Lite +, [K2.0054619](#)
For Artemis 2 Live



ARTEMIS Carbon Spring Arm, 23kg/50.7lb, Pro Set, range of payload 19-23 kg, [KK.0020297](#)
Consists of:
ARTEMIS Carbon Spring Arm, 23kg/50.7lb [K2.0010331](#)
6 mm Hex Key 1/4" [K2.0010435](#)
4 mm Hex Key / 5/32" [K2.0010434](#)
Arm Soft Bag [K2.0010463](#)

ARTEMIS Carbon Spring Arm, 19kg/41.8lb, Pro Set, range of payload 15-19 kg, [KK.0020296](#) *

ARTEMIS Carbon Spring Arm, 26kg/57.3lb, Pro Set, range of payload 23-26 kg, [KK.0020298](#) *

ARTEMIS Carbon Spring Arm, 30kg/66.1lb, Pro Set, range of payload 26-30 kg, [KK.0039452](#) *



Rain Cover Spring Arm, [K2.0010465](#)



ARTEMIS Vest, [K2.0010333](#)

*** discontinued - only as long as stock is available**

ARTEMIS 2 - Basic Sets



ARTEMIS 2, 1.8" Standard Post, Basic Set, [KK.0044424](#)

- Key features
- Payload up to 40 Kg/88 lb
 - 12V & 24V high-capacity system and camera power supply
 - LBUS, CAN Bus, tally through
 - 2 x 12G video
 - 1.8in telescopic center post with fine trim length adjustment
 - 1.8in super-low friction gimbal
 - Regulated high-capacity battery management
 - Interchangeable BMS-2 battery mounts
 - Battery communication

- includes:
- [K2.0041201](#) 1x Stabilizer Adapter Mount SAM-Zero
 - [K2.0039443](#) 1x Cam Pwr Gen.2, ALEXA 35, Mini, AMIRA, 24 V, 8-pin
 - [K2.0039448](#) 1x Cam Pwr Gen.2, 4-pin XLR, 12 V
 - [K2.0041984](#) 1x 12G HD SDI BNC Cable, 0,63m/25in
 - [K2.0010319](#) 1x ARTEMIS Docking Bracket, 1.8in
 - [K2.0040046](#) 1x CSS Post Tool for ARTEMIS and TRINITY
 - [K2.0010493](#) 1x ARTEMIS Gimbal, Ø1.8in
 - [K2.0038249](#) 1x TST-2, ARTEMIS Top Stage, Gen. 2, 16 pin
 - [K2.0010489](#) 1x ARTEMIS Carbon Center Post, Ø1.8in
 - [K2.0040332](#) 1x Post Main Cable, 3B, 16pin
 - [K2.0039975](#) 1x BST-2, ARTEMIS 2 Bottom Stage, 16pin
 - [K2.0037739](#) 1x BHM-2, Battery Hanger Module, Gen.2
 - [K2.0037771](#) 1x Power Cable, BHM-2 to TST, 12V, 24V, Bat. Data
 - [K2.0041327](#) 1x Support Rods 305mm, 12in, Ø19mm
 - [K2.0040790](#) 1x Support Rods 120mm, 4.7in, Ø19mm
 - [K2.0037757](#) 1x Hinge for Battery Hanger Module, Gen.2, Ø19mm
 - [K2.0039300](#) 2x BMS-2, Battery Mounting Base, Gen.2, (naked)
 - [O5.15642.0](#) 1x Hex Key 3mm/0.11in

NOTE
To complete the initial order, at least one of the mandatory battery mounting sets must be ordered.
The customer can only put the system into operation if the basic set and the battery mounting set were ordered and delivered together.

- Mandatory battery sets:
- Gold Mount for BMS-1 / BMS-2, Set ([KO.0044355](#))
 - V-Mount for BMS-1 / BMS-2, Set ([KO.0044356](#))
 - B-Mount for BMS-2, Set ([KO.0044357](#))

- Recommended optional monitor sets:
- SM7 Pro 3G Monitor Live Set ([KO.0052196](#))
 - SM7 Pro 3G Monitor Cine Set ([KO.0052201](#))



ARTEMIS 2, 1.8in Shorty Post, Basic Set, [KK.0044510](#)

- Key features
- Payload up to 40 Kg/88 lb
 - 12V & 24V high-capacity system and camera power supply
 - LBUS, CAN Bus, tally through
 - 2 x 12G video
 - 1.8in telescopic center post with fine trim length adjustment
 - 1.8in super-low friction gimbal with gimbal handle extension
 - Regulated high-capacity battery management
 - Interchangeable BMS-2 battery mounts
 - Battery communication

- includes:
- [K2.0038249](#) 1x TST-2, ARTEMIS Top Stage, Gen. 2, 16 pin
 - [K2.0041201](#) 1x Stabilizer Adapter Mount SAM-Zero
 - [K2.0039443](#) 1x Cam Pwr Gen.2, ALEXA 35, Mini, AMIRA, 24 V, 8-pin
 - [K2.0039448](#) 1x Cam Pwr Gen.2, 4-pin XLR, 12 V
 - [K2.0041984](#) 1x 12G HD SDI BNC Cable, 0,63m/25in
 - [K2.0010319](#) 1x ARTEMIS Docking Bracket, 1.8in
 - [K2.0040046](#) 1x CSS Post Tool for ARTEMIS and TRINITY
 - [O5.15642.0](#) 1x Hex Key 3mm/0.11in
 - [K2.0010493](#) 1x ARTEMIS Gimbal, Ø1.8in
 - [K2.0010569](#) 1x Gimbal Handle Extender for 1.8in Gimbal
 - [K2.0041474](#) 1x ARTEMIS Carbon Center Post, Ø1.8in, Short, No Main Cable
 - [K2.0040332](#) 1x Post Main Cable, 3B, 16pin
 - [K2.0039975](#) 1x BST-2, ARTEMIS 2 Bottom Stage, 16pin
 - [K2.0037739](#) 1x BHM-2, Battery Hanger Module, Gen.2
 - [K2.0037771](#) 1x Power Cable, BHM-2 to TST, 12V, 24V, Bat. Data
 - [K2.0041327](#) 1x Support Rods 305mm, 12in, Ø19mm
 - [K2.0040790](#) 1x Support Rods 120mm, 4.7in, Ø19mm
 - [K2.0037757](#) 1x Hinge for Battery Hanger Module, Gen.2, Ø19mm
 - [K2.0039300](#) 2x BMS-2, Battery Mounting Base, Gen.2, (naked)

NOTE
To complete the initial order, at least one of the mandatory battery mounting sets must be ordered.
The customer can only put the system into operation if the basic set and the battery mounting set were ordered and delivered together.

- Mandatory battery sets:
- Gold Mount for BMS-1 / BMS-2, Set ([KO.0044355](#))
 - V-Mount for BMS-1 / BMS-2, Set ([KO.0044356](#))
 - B-Mount for BMS-2, Set ([KO.0044357](#))

- Recommended optional monitor sets:
- SM7 Pro 3G Monitor Live Set ([KO.0052196](#))
 - SM7 Pro 3G Monitor Cine Set ([KO.0052201](#))
 - SmallHD 703 Monitor Live Set ([KO.0052692](#))

ARTEMIS 2 Live Sets

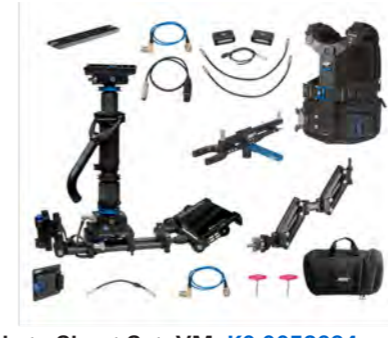

ARTEMIS 2 Live Ready to Shoot Set, VM, [KO.0052694](#)

- includes:
- 1x [KK.0052630](#) ARTEMIS 2 Live 1.8 in Shorty, 1.8 in Gimbal
 - 1x [K2.0052057](#) Power Cable 12V/12V In - 12V Hot Swap Out, BHM
 - 1x [K2.0040286](#) V-Mount for BMS-1 / BMS-2
 - 1x [K2.0010333](#) ARTEMIS Vest
 - 1x [KK.0020297](#) ARTEMIS Carbon Spring Arm, 23kg/50.7lb, Pro Set
 - 1x [K2.0041765](#) SmallHD 703 Monitor
 - 1x [K2.0052172](#) Monitor Yoke, SmallHD 7in
 - 1x [K2.0050835](#) MMA-2, Second Monitor Mounting Adapter
 - 1x [K2.0049885](#) CCB-2, CSS Clamp Bridge-2, 52, 19mm
 - 1x [K2.0041984](#) 12G HD SDI BNC Cable, 0,63m/25in
 - 1x [K2.0041723](#) Monitor Power, 12V, Lemo 0B 2pin, 0B 2pin
 - 1x [K2.0044490](#) Tally System Gen.2 / Host
 - 1x [K2.0044491](#) Tally System Gen.2 / Client
 - 1x [K2.0010482](#) Tally Sensor Cable, Gen.1&2
 - 2x [K2.0044143](#) Tally Gen.2 Pwr, TST-2, Fischer 3pin to Lemo 0S 3pin, 0,35m / 13.7in
 - 1x [K2.0010436](#) Hex Key 2mm



ARTEMIS 2 Live Ready to Shoot Set, GM, [KO.0052730](#)

- includes:
- 1x [KK.0052630](#) 1x ARTEMIS 2 Live 1.8in Shorty
 - 1x [K2.0052057](#) 1x Power Cable 12V/12V In - 12V Hot Swap Out, BHM
 - 1x [K2.0040285](#) 1x Gold Mount for BMS-1 / BMS-2
 - 1x [K2.0010333](#) 1x ARTEMIS Vest
 - 1x [KK.0020297](#) 1x ARTEMIS Carbon Spring Arm, 23kg/50.7lb, Pro Set
 - [K2.0041765](#) 1x SmallHD 703 Monitor
 - [K2.0052172](#) 1x Monitor Yoke SmallHD 7in
 - [K2.0050835](#) 1x MMA-2 Monitor Mounting Adapter 2
 - [K2.0049885](#) 1x CCB-2, CSS Clamp Bridge-2, 52, 19mm
 - [K2.0041984](#) 1x 12G HD SDI BNC Cable, 0,63m/25in
 - [K2.0041723](#) 1x Monitor Power, 12V, Lemo 0B 2-pin to 0B 2-pin
 - [K2.0044490](#) 1x Tally System Gen2 / Host
 - [K2.0044491](#) 1x Tally System Gen2 / Client
 - [K2.0010482](#) 1x Tally Sensor Cable, Gen.1 & 2
 - [K2.0044143](#) 2x Tally Gen.2 Pwr, TST-2, Fischer 3pin to Lemo 0S 3pin, 0,35m / 13.7in
 - 1x [K2.0010436](#) Hex Key 2mm

ARTEMIS 2 Live 1.8in Shorty, [KK.0052630](#)

- includes:
- 1x [K2.0041474](#) Carbon Center Post, 1.8in, Short
 - 2x [K2.0049885](#) CCB-2, CSS Clamp Bridge-2, 52, 19mm
 - 1x [K2.0010319](#) ARTEMIS Docking Bracket, 1.8in
 - 1x [K2.0010493](#) ARTEMIS Gimbal, Ø1.8in
 - 1x [K2.0052045](#) BHM-3 ARTEMIS Live Battery Hanger Plate
 - 1x [K2.0039300](#) BMS-2, Battery Mounting Base
 - 1x [K2.0039975](#) BST-2, Bottom Stage, Gen.2, 16pin
 - 1x [K2.0010569](#) Gimbal Handle Extender for 1.8in Gimbal
 - 1x [K2.0037757](#) Hinge for BHM-2, Gen.2, Ø19mm
 - 1x [K2.0040332](#) Post Main Cable, 3B, 16pin
 - 1x [O5.15642.0](#) Hex Key 3mm/0.11in
 - 1x [K2.0041201](#) Stabilizer Adapter Mount SAM-Zero
 - 1x [K2.0040790](#) Support Rods 120mm, 4.7in, Ø19mm
 - 1x [K2.0041327](#) Support Rods 305mm, 12in, Ø19mm
 - 1x [K2.0038249](#) TST-2, Top Stage, Gen.2, 16pin
 - 1x [K2.0039448](#) Cam Pwr Gen.2, 4 pin XLR, 12V
 - 1x [K2.0041984](#) 12G HD SDI BNC Cable, 0,63m/25in
 - 1x [K2.0040046](#) CSS Post Tool for ARTEMIS and TRINITY

NOTE
When ordering [KK.0052630](#) ARTEMIS 2 Live 1.8in Shorty, the following components are mandatory and need to be ordered separately:



- Power Cable 12V/12V In - 12V Hot Swap Out, BHM, [K2.0052057](#)
- Power Cable 12V/12V In - 12V/24V Out, BHM [K2.0052139](#)
- Power Cable 12V/24V In - 12V/24V Out, BHM [K2.0052140](#)



- Gold Mount for BMS-1 / BMS-2, [K2.0040285](#)
- V-Mount for BMS-1 / BMS-2, [K2.0040286](#)
- B-Mount 12V for BMS-2, [K2.0053830](#)



- SmallHD 703 Monitor Live Set, [KO.0052692](#)**
- includes:
- [K2.0041765](#) 1x SmallHD 703 Monitor
 - [K2.0052172](#) 1x Monitor Yoke SmallHD 7in
 - [K2.0050835](#) 1x MMA-2 Monitor Mounting Adapter 2
 - [K2.0049885](#) 1x CCB-2, CSS Clamp Bridge-2, 52, 19mm
 - [K2.0041984](#) 1x 12G HD SDI BNC Cable, 0,63m/25in
 - [K2.0041723](#) 1x Monitor Power, 12V, Lemo 0B 2-pin to 0B 2-pin
 - [K2.0010436](#) 1x Hex Key 2mm

ARTEMIS 2 Volt - Basic Set (Tiffen Volt not included)



ARTEMIS 2, Volt Post, Basic Set, [KK.0044425](#)

This special version comes with the Volt center post. It does not include a gimbal or docking bracket.

Key features:

- Payload up to 40 Kg / 88 lb
- 12V & 24V high-capacity system and camera power supply
- LBUS, CAN Bus, tally through
- 2 x 12G video
- Regulated high-capacity battery management
- Interchangeable BMS-2 battery mounts
- Battery communication

includes:

- [K2.0041201](#) 1x Stabilizer Adapter Mount SAM-Zero
- [K2.0039443](#) 1x Cam Pwr Gen.2, ALEXA 35, Mini, AMIRA, 24 V, 8-pin
- [K2.0039448](#) 1x Cam Pwr Gen.2, 4-pin XLR, 12 V
- [K2.0041984](#) 1x 12G HD SDI BNC Cable, 0,63m/25in
- K2.0040046 1x CSS Post Tool for ARTEMIS and TRINITY
- [K2.0038249](#) 1x TST-2, ARTEMIS Top Stage, Gen. 2, 16 pin
- K2.0036904 1x ARTEMIS Carbon Center Post, ø1.74, Volt
- [K2.0040332](#) 1x Post Main Cable, 3B, 16pin
- [K2.0039975](#) 1x BST-2, ARTEMIS 2 Bottom Stage, 16pin
- K2.0037739 1x BHM-2, Battery Hanger Module, Gen.2
- [K2.0037771](#) 1x Power Cable, BHM-2 to TST, 12V, 24V, Bat. Data
- K2.0041327 1x Support Rods 305mm, 12in, Ø19mm
- K2.0040790 1x Support Rods 120mm, 4.7in, Ø19mm
- [K2.0037757](#) 1x Hinge for Battery Hanger Module, Gen.2, Ø19mm
- [K2.0039300](#) 2x BMS-2, Battery Mounting Base, Gen.2, (naked)
- [K2.0037460](#) 1x Volt Pwr Cable 0B 3-pin to 0B 2-pin, 0.4 m/1.3ft
- [K2.0037912](#) 1x SSB-3, Stabilizer System Bracket for TRINITY, MAXIMA and SAM plates

NOTE

To complete the initial order, at least one of the mandatory battery mounting sets must be ordered.

The customer can only put the system into operation if the basic set and the battery mounting set were ordered and delivered together.

Mandatory battery sets:

- Gold Mount for BMS-1 / BMS-2, Set ([K0.0044355](#))
- V-Mount for BMS-1 / BMS-2, Set ([K0.0044356](#))
- B-Mount for BMS-2, Set ([K0.0044357](#))

Recommended optional monitor sets:

- SM7 Pro 3G Monitor Live Set ([K0.0052196](#))
- SM7 Pro 3G Monitor Cine Set ([K0.0052201](#))

ARTEMIS 2, Volt Shorty Post, Basic Set, [KK.0049907](#)

This special version comes with the short Volt center post. It does not include a gimbal or docking bracket.

- Key features: Payload up to 40 kg/88 lb, 12 V & 24 V high-capacity system and camera power supply, LBUS, CAN Bus, tally through 2 x 12G video, regulated high-capacity battery management, interchangeable BMS-2 battery mounts, battery communication.

NOTE

To complete the initial order, at least one of the mandatory battery mounting sets must be ordered. The customer can only put the system into operation if the basic set and the battery mounting set were ordered and delivered together.

includes:

- [K2.0041201](#) 1x Stabilizer Adapter Mount SAM-Zero
- K2.0049207 1x artemis Carbon Center Post, 1.74, Volt, Short, No Main Cable
- [K2.0037912](#) 1x SSB-3, Stabilizer System Bracket for TRINITY, MAXIMA, SAM plates
- K2.0040790 1x Support Rods 120mm, 4.7in, Ø19mm
- K2.0041327 1x Support Rods 305mm, 12in, Ø19mm
- [K2.0037757](#) 1x Hinge for Battery Hanger Module, Gen.2, Ø19mm
- K2.0037739 1x BHM-2, Battery Hanger Module, Gen.2
- [K2.0038249](#) 1x TST-2, ARTEMIS Top Stage, Gen. 2, 16 pin
- [K2.0040332](#) 1x Post Main Cable, 3B, 16pin
- [K2.0039300](#) 2x BMS-2, Battery Mounting Base, Gen.2, (naked)
- [K2.0039975](#) 1x BST-2, ARTEMIS 2 Bottom Stage, 16pin
- O5.15642.0 1x Hex Key 3mm/0.11in
- [K2.0039443](#) 1x Cam Pwr Gen.2, ALEXA 35, Mini, AMIRA, 24 V, 8-pin
- [K2.0039448](#) 1x Cam Pwr Gen.2, 4-pin XLR, 12 V
- K2.0040046 1x CSS Post Tool for ARTEMIS and TRINITY
- [K2.0037771](#) 1x Power Cable, BHM-2 to TST, 12V, 24V, Bat. Data
- [K2.0037460](#) 1x Volt Pwr Cable 0B 3-pin to 0B 2-pin, 0.4 m/1.3ft
- [K2.0041984](#) 1x 12G HD SDI BNC Cable, 0,63m/25in

Mandatory battery sets:

- Gold Mount for BMS-1 / BMS-2, Set ([K0.0044355](#))
- V-Mount for BMS-1 / BMS-2, Set ([K0.0044356](#))
- B-Mount for BMS-2, Set ([K0.0044357](#))

Recommended optional monitor sets:

- SM7 Pro 3G Monitor Live Set ([K0.0052196](#))
- SM7 Pro 3G Monitor Cine Set ([K0.0052201](#))

ARTEMIS 2 Volt - Set (Tiffen Volt not included)

Carbon Center Post, Volt Gimbal, Pro Set, [K0.0048623](#)

includes:

- K2.0036904 1x ARTEMIS Carbon Center Post, ø1.74, Volt
- [K2.0037460](#) 1x Volt Pwr Cable 0B 3-pin to 0B 2-pin, 0.4 m/1.3ft
- [K2.0037912](#) 1x SSB-3, Stabilizer System Bracket for TRINITY, MAXIMA, SAM plates
- [K2.0040244](#) 1x Arm Post ø0.74in / 18,7mm, Volt Gimbal
- [K2.0049047](#) 1x Docking Pin Sleeves for Tiffen Volt Gimbal

Carbon Center Post, Short, Volt Gimbal, Pro Set, [K0.0053947](#)

includes:

- K2.0049207 1x ARTEMIS 2 Carbon Center Post, ø1.74, Volt, Short, No Main Cable
- [K2.0037460](#) 1x Volt Pwr Cable 0B 3-pin to 0B 2-pin, 0.4 m/1.3ft
- [K2.0037912](#) 1x SSB-3, Stabilizer System Bracket for TRINITY, MAXIMA, SAM plates
- [K2.0040244](#) 1x Arm Post ø0.74in / 18,7mm, Volt Gimbal
- [K2.0049047](#) 1x Docking Pin Sleeves for Tiffen Volt Gimbal

ARTEMIS 2 Carbon Center Post, ø1.74, Volt, Short, No Main Cable, K2.0049207

Volt Pwr Cable 0B 3-pin to 0B 2-pin, 0.4 m/1.3ft, [K2.0037460](#)

SSB-3, Stabilizer System Bracket for TRINITY, MAXIMA, SAM plates, [K2.0037912](#)

ARTEMIS Carbon Center Post, ø1.74, Volt, K2.0036904

Arm Post 0,7 Volt Gimbl, [K2.0040244](#)

Docking Pin Sleeves for Tiffen Volt Gimbal, [K2.0049047](#)



1.8in Gimbal Adapter Set f. Volt Post, [K0.0040291](#)

Includes:

- K2.0040249 1x Lower clamp sleeve, 1.8in Gimbal
- K2.0040250 1x Upper centering ring, 1.8in Gimbal



Arm Post Clamp Ring 5/8", K2.0010510 *



MMA-4, Low Mode Monitor Mounting Adapter, [K2.0050573](#)

* discontinued - only as long as stock is available

ARTEMIS 2 Live Volt - Sets (Tiffen Volt not included)



ARTEMIS 2 Live VOLT Ready to Shoot Set, VM, [K0.0052695](#)

- includes:
- 1x [KK.0052647](#) ARTEMIS 2 Live Volt Shorty, No Gimbal
 - 1x [K2.0052057](#) Power Cable 12V/12V In - 12V Hot Swap Out, BHM
 - 1x [K2.0040286](#) V-Mount for BMS-1 / BMS-2
 - 1x [K2.0010333](#) ARTEMIS Vest
 - 1x [KK.0020297](#) ARTEMIS Carbon Spring Arm, 23kg/50.7lb, Pro Set
 - 1x K2.0041765 SmallHD 703 Monitor
 - 1x [K2.0052172](#) Monitor Yoke, SmallHD 7in
 - 1x [K2.0050835](#) MMA-2, Second Monitor Mounting Adapter
 - 1x [K2.0049885](#) CCB-2, CSS Clamp Bridge-2, 52, 19mm
 - 1x [K2.0041984](#) 12G HD SDI BNC Cable, 0,63m/25in
 - 1x [K2.0041723](#) Monitor Power, 12V, Lemo 0B 2pin, 0B 2pin
 - 1x K2.0044490 Tally System Gen.2 / Host
 - 1x K2.0044491 Tally System Gen.2 / Client
 - 1x [K2.0010482](#) Tally Sensor Cable, Gen.1&2
 - 2x K2.0044143 Tally Gen.2 Pwr, TST-2, Fischer 3pin to Lemo 0S 3pin, 0,35m / 13.7in
 - 1x K2.0010436 Hex Key 2mm

NOTE

Please note that for the TIFFEN Volt gimbal version, the customer must provide the Volt gimbal, cables and Tiffen docking bracket.



ARTEMIS 2 Live VOLT Ready to Shoot Set, GM, [K0.0052731](#)

- includes:
- 1x [KK.0052647](#) ARTEMIS 2 Live Volt Shorty, No Gimbal
 - 1x [K2.0052057](#) Power Cable 12V/12V In - 12V Hot Swap Out, BHM
 - 1x [K2.0040285](#) Gold-Mount for BMS-1 / BMS-2
 - 1x [K2.0010333](#) ARTEMIS Vest
 - 1x [KK.0020297](#) ARTEMIS Carbon Spring Arm, 23kg/50.7lb, Pro Set
 - 1x K2.0041765 SmallHD 703 Monitor
 - 1x [K2.0052172](#) Monitor Yoke, SmallHD 7in
 - 1x [K2.0050835](#) MMA-2, Second Monitor Mounting Adapter
 - 1x [K2.0049885](#) CCB-2, CSS Clamp Bridge-2, 52, 19mm
 - 1x [K2.0041984](#) 12G HD SDI BNC Cable, 0,63m/25in
 - 1x [K2.0041723](#) Monitor Power, 12V, Lemo 0B 2pin, 0B 2pin
 - 1x K2.0044490 Tally System Gen.2 / Host
 - 1x K2.0044491 Tally System Gen.2 / Client
 - 1x [K2.0010482](#) Tally Sensor Cable, Gen.1&2
 - 2x K2.0044143 Tally Gen.2 Pwr, TST-2, Fischer 3pin to Lemo 0S 3pin, 0,35m / 13.7in
 - 1x K2.0010436 Hex Key 2mm

NOTE

Please note that for the TIFFEN Volt gimbal version, the customer must provide the Volt gimbal, cables and Tiffen docking bracket.



ARTEMIS 2 Live Volt Shorty - No Gimbal, [KK.0052647](#)

- includes:
- 1x K2.0049207 ARTEMIS Carbon Center Post, Ø1.74, Volt, Short
 - 2x [K2.0049885](#) CCB-2, CSS Clamp Bridge-2, 52, 19mm
 - 1x K2.0052045 BHM-3 ARTEMIS Live Battery Hanger Plate
 - 1x [K2.0039300](#) BMS-2, Battery Mounting Base
 - 1x [K2.0039975](#) BST-2, Bottom Stage, Gen.2, 16pin
 - 1x [K2.0037757](#) Hinge for BHM-2, Gen.2, Ø19mm
 - 1x [K2.0040332](#) Post Main Cable, 3B, 16pin
 - 1x 05.15642.0 Hex Key 3mm/0.11in
 - 1x [K2.0041201](#) Stabilizer Adapter Mount SAM-Zero
 - 1x K2.0040790 Support Rods 120mm, 4.7in, Ø19mm
 - 1x K2.0041327 Support Rods 305mm, 12in, Ø19mm
 - 1x [K2.0038249](#) TST-2, Top Stage, Gen.2, 16pin
 - 1x [K2.0039448](#) Cam Pwr Gen.2, 4 pin XLR, 12V
 - 1x [K2.0041984](#) 12G HD SDI BNC Cable, 0,63m/25in
 - 1x K2.0040046 CSS Post Tool for ARTEMIS and TRINITY
 - 1x [K2.0037460](#) Volt Pwr Cable 0B 3p - 0B 2p, 0.3m/0.9ft
 - 1x [K2.0037912](#) SSB-3, Stabilizer System Bracket for TRINITY, MAXI-MA, SAM plates

NOTE

When ordering [KK.0052630](#) ARTEMIS 2 Live 1.8in Shorty, the following components are mandatory and need to be ordered separately:



- Power Cable 12V/12V In - 12V Hot Swap Out, BHM, [K2.0052057](#)
- Power Cable 12V/12V In - 12V/24V Out, BHM [K2.0052139](#)
- Power Cable 12V/24V In - 12V/24V Out, BHM [K2.0052140](#)



- Gold Mount for BMS-1 / BMS-2, [K2.0040285](#)
- V-Mount for BMS-1 / BMS-2, [K2.0040286](#)
- B-Mount 12V for BMS-2, [K2.0053830](#)

Monitor for Live Applications



SmallHD 703 Monitor Live Set, [K0.0052692](#)

- includes:
- K2.0041765 1x SmallHD 703 Monitor
 - [K2.0052172](#) 1x Monitor Yoke SmallHD 7in
 - [K2.0050835](#) 1x MMA-2 Monitor Mounting Adapter 2
 - [K2.0049885](#) 1x CCB-2, CSS Clamp Bridge-2, 52, 19mm
 - [K2.0041984](#) 1x 12G HD SDI BNC Cable, 0,63m/25in
 - [K2.0041723](#) 1x Monitor Power, 12V, Lemo 0B 2-pin to 0B 2-pin
 - K2.0010436 1x Hex Key 2mm



SM7 Pro 3G Monitor Live Set, [K0.0052196](#)

- includes:
- K2.0052052 1x SM7 Pro 3G Monitor, 7in, 3200 Nits
 - [K2.0051225](#) 1x Monitor Yoke SM7 Pro
 - [K2.0050835](#) 1x MMA-2 Monitor Mounting Adapter 2
 - [K2.0049885](#) 1x CCB-2, CSS Clamp Bridge-2, 52, 19mm
 - [K2.0041984](#) 1x 12G HD SDI BNC Cable, 0,63m/25in
 - [K2.0041723](#) 1x Monitor Power, 12V, Lemo 0B 2-pin to 0B 2-pin



SM7 Pro 3G Monitor Cine Set, [K0.0052201](#)

- includes:
- K2.0052052 1x SM7 Pro 3G Monitor, 7in, 3200 Nits
 - [K2.0051225](#) 1x Monitor Yoke SM7 Pro
 - [K2.0051654](#) 1x MMA-1, Main Monitor Mounting Adapter
 - [K2.0041984](#) 1x 12G HD SDI BNC Cable, 0,63m/25in
 - [K2.0041723](#) 1x Monitor Power, 12V, Lemo 0B 2-pin to 0B 2-pin

ARTEMIS 2 - Mandatory and Optional Sets



Configuration Overview | 8.1.4 / 2025.08

Mandatory Battery Mounts



B-Mount 12V for BMS-2
[K2.0053830](#)



Gold Mount for BMS-1 / BMS-2, Set, includes: [K0.0044355](#)
Gold Mount for BMS-1 / BMS-2 (2x) [K2.0040285](#)



V-Mount for BMS-1 / BMS-2, Set, includes: [K0.0044356](#)
V-Mount for BMS-1 / BMS-2 (2x) [K2.0040286](#)



B-Mount for BMS-2, Set, includes: [K0.0044357](#)
B-Mount for BMS-2 (2x) [K2.0040284](#)

Live Optional Monitor Sets



SmallHD 703 Monitor Live Set, [K0.0052692](#)
includes:
K2.0041765 1x SmallHD 703 Monitor
[K2.0052172](#) 1x Monitor Yoke SmallHD 7in
[K2.0050835](#) 1x MMA-2 Monitor Mounting Adapter 2
[K2.0049885](#) 1x CCB-2, CSS Clamp Bridge-2, 52, 19mm
[K2.0041984](#) 1x 12G HD SDI BNC Cable, 0,63m/25in
[K2.0041723](#) 1x Monitor Power, 12V, Lemo 0B 2-pin to 0B 2-pin
K2.0010436 1x Hex Key 2mm



SM7 Pro 3G Monitor Live Set, [K0.0052196](#)
includes:
K2.0052052 1x SM7 Pro 3G Monitor, 7in, 3200 Nits
[K2.0051225](#) 1x Monitor Yoke SM7 Pro
[K2.0050835](#) 1x MMA-2 Monitor Mounting Adapter 2
[K2.0049885](#) 1x CCB-2, CSS Clamp Bridge-2, 52, 19mm
[K2.0041984](#) 1x 12G HD SDI BNC Cable, 0,63m/25in
[K2.0041723](#) 1x Monitor Power, 12V, Lemo 0B 2-pin to 0B 2-pin

Optional Monitor Parts



ARTEMIS Monitor Bracket, Gen.2, 6in Transvideo Cine,
K2.0042716



ARTEMIS Monitor Bracket, Gen.2, 8in Transvideo Cine,
K2.0042717



Monitor Yoke SmallHD 7in
[K2.0052172](#)



Monitor Yoke, Transvideo Stargate,
[K2.0052173](#)



Monitor Yoke SM7 Pro,
[K2.0051225](#)



Side Bracket Upgrade, 6in, SM7 Pro,
[K2.0052168](#)



Low Mode Monitor Mounting Set,
[K0.0052258](#)



Monitor Mounting Set, Rods,
[K0.0052203](#)



MMA-1 Main Monitor Mounting Adapter,
[K2.0051654](#)



MMA-2 Monitor Mounting Adapter 2,
[K2.0050835](#)



MMA-3 Monitor Mounting Adapter 3,
[K2.0050825](#)



MMA-4, Low Mode Monitor Mounting Adapter,
[K2.0050573](#)



Second Monitor Mounting Set,
[K0.0052202](#)

ARTEMIS Arm Sets and Vest



SmartSystem ArmX1,
K2.0054618
For TRINITY 2, ARTEMIS, 2
Artemis 2 Live



SmartSystem ArmX1Lite +,
K2.0054619
For Artemis 2 Live



ARTEMIS Carbon Spring Arm, 23kg/50.7lb, Pro Set, range of payload 19-23 kg [KK.0020297](#)
Consists of:
ARTEMIS Carbon Spring Arm, 23kg/50.7lb K2.0010331
6 mm Hex Key 1/4" K2.0010435
4 mm Hex Key / 5/32" K2.0010434
Arm Soft Bag K2.0010463

ARTEMIS Carbon Spring Arm, 19kg/41.8lb, Pro Set, range of payload 15-19 kg [KK.0020296 *](#)

ARTEMIS Carbon Spring Arm, 26kg/57.3lb, Pro Set, range of payload 23-26 kg [KK.0020298 *](#)

ARTEMIS Carbon Spring Arm, 30kg/66.1lb, Pro Set, range of payload 26-30 kg [KK.0039452 *](#)

To upgrade/downgrade the arm to another weight:



Spring Set for Spring Arm, 19kg/41.8lb K2.0010500 *
Spring Set for Spring Arm, 23kg/50.7lb K2.0010501 *
Spring Set for Spring Arm, 26kg/57.3lb K2.0010502 *
Spring Set for Spring Arm, 30kg/66lb K2.0037438 *



ARTEMIS Vest,
[K2.0010333](#)



Rain Cover Spring Arm,
[K2.0010465](#)

* discontinued - only as long as stock is available

CSS Protection



Case TRINITY 2 & ARTEMIS 2, Rig, SKB 3i-4217-7,
[K2.0044440](#)
for ARTEMIS 2 / TRINITY 2



Rain Cover Lower Sled
[K2.0010466](#)

ARTEMIS 2 Live - Power Options



Configuration Overview | 8.1.5 / 2025.02

Mandatory Battery Mounts

V-Mount for BMS-1 / Gold Mount for BMS-1 / B-Mount 12V for BMS-2, [K2.0040286](#) V-Mount for BMS-1 / Gold Mount for BMS-1 / B-Mount 12V for BMS-2, [K2.0040285](#) V-Mount for BMS-1 / Gold Mount for BMS-1 / B-Mount 12V for BMS-2, [K2.0053830](#) V-Mount for BMS-1 / Gold Mount for BMS-1 / B-Mount 12V for BMS-2, [K2.0040286](#) V-Mount for BMS-1 / Gold Mount for BMS-1 / B-Mount 12V for BMS-2, [K2.0040285](#) V-Mount for BMS-1 / Gold Mount for BMS-1 / B-Mount 12V for BMS-2, [K2.0053830](#) V-Mount for BMS-1 / Gold Mount for BMS-1 / B-Mount 12V for BMS-2, [K2.0040286](#) V-Mount for BMS-1 / Gold Mount for BMS-1 / B-Mount 12V for BMS-2, [K2.0040285](#) V-Mount for BMS-1 / Gold Mount for BMS-1 / B-Mount 12V for BMS-2, [K2.0053830](#)

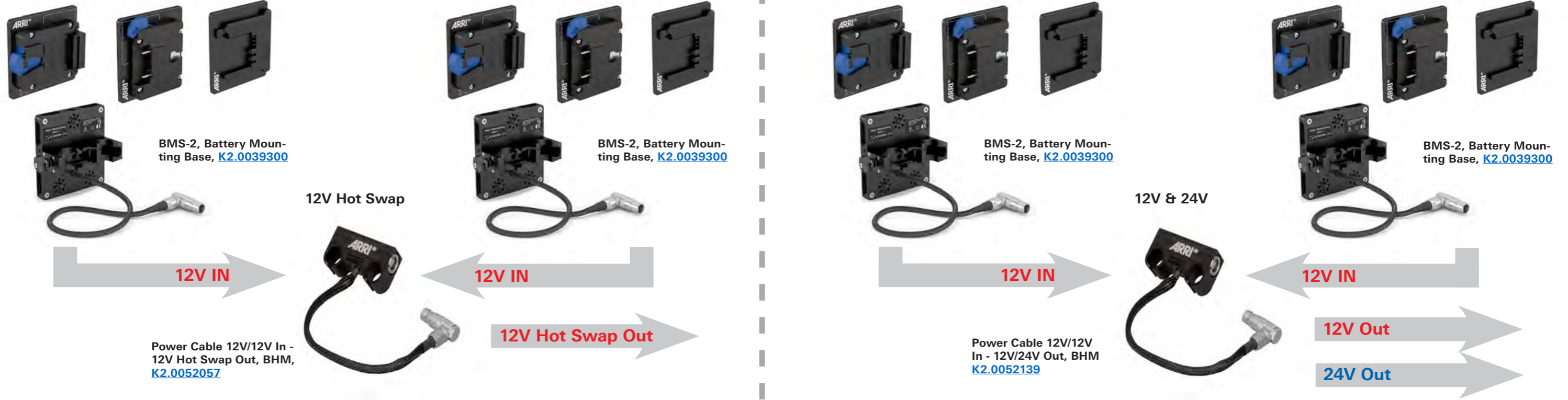

B-Mount 24 V for BMS-2, [K2.0040284](#)

V-Mount for BMS-1 / Gold Mount for BMS-1 / B-Mount 12V for BMS-2, [K2.0040286](#) V-Mount for BMS-1 / Gold Mount for BMS-1 / B-Mount 12V for BMS-2, [K2.0040285](#) V-Mount for BMS-1 / Gold Mount for BMS-1 / B-Mount 12V for BMS-2, [K2.0053830](#)

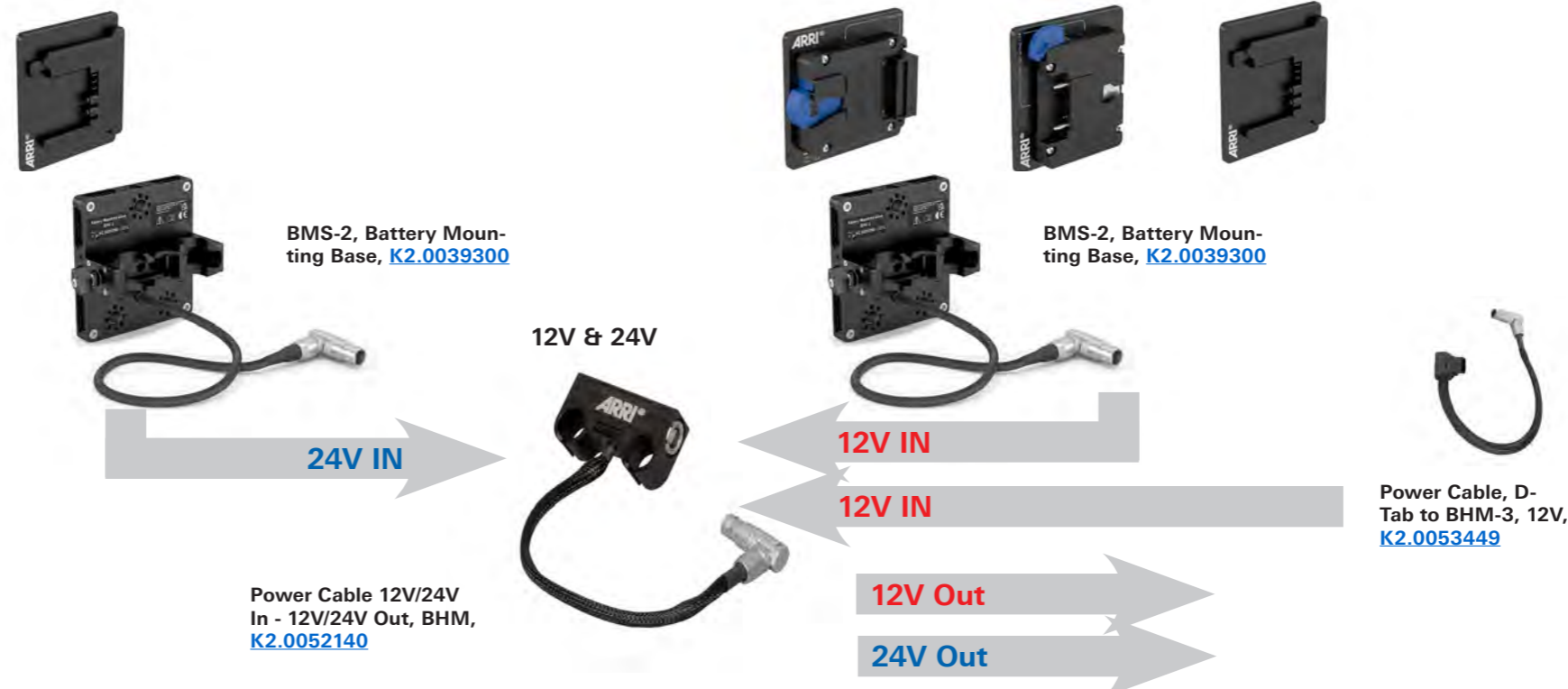

TRINITY 2 - General Overview



Configuration Overview | 8.2.0 / 2025.08

TRINITY 2 Overview

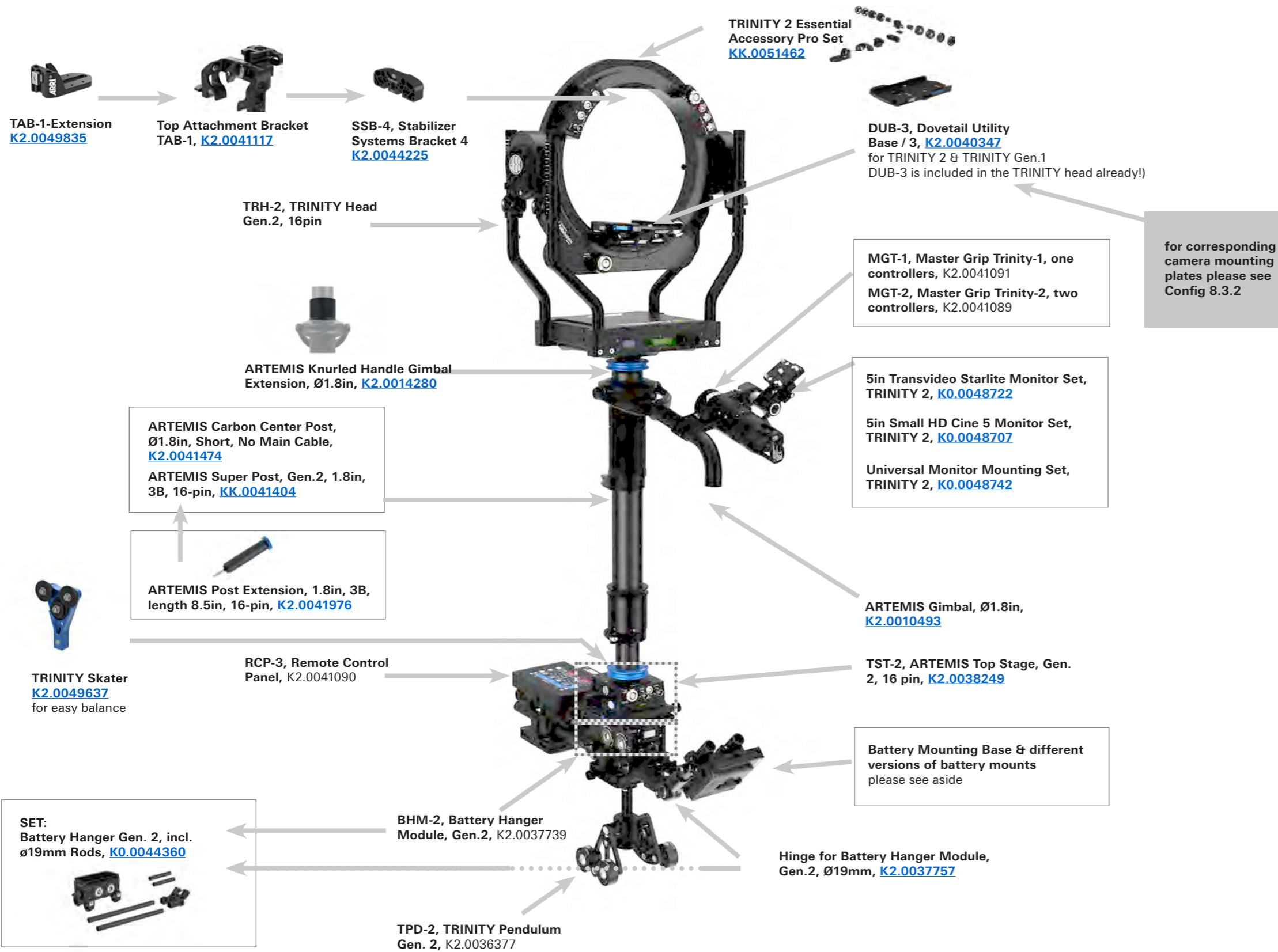

ARTEMIS Arm Sets and Vest

SmartSystem ArmX1,
K2.0054618
For TRINITY 2, ARTEMIS, 2
Artemis 2 Live

SmartSystem ArmX1Lite +,
K2.0054619
For Artemis 2 Live

ARTEMIS Carbon Spring Arm, 23kg/50.7lb, Pro Set, range of payload 19-23 kg
Consists of:
ARTEMIS Carbon Spring Arm, 23kg/50.7lb
6 mm Hex Key 1/4"
4 mm Hex Key / 5/32"
Arm Soft Bag

	<p>KK.0020297</p> <p>K2.0010331</p> <p>K2.0010435</p> <p>K2.0010434</p> <p>K2.0010463</p>
--	---

ARTEMIS Carbon Spring Arm, 19kg/41.8lb, Pro Set, range of payload 15-19 kg

KK.0020296 *

ARTEMIS Carbon Spring Arm, 26kg/57.3lb, Pro Set, range of payload 23-26 kg

KK.0020298 *

ARTEMIS Carbon Spring Arm, 30kg/66.1lb, Pro Set, range of payload 26-30 kg

KK.0039452 *

Rain Cover Spring Arm, K2.0010465

ARTEMIS Vest,
K2.0010333

* discontinued - only as long as stock is available

Basic Set



TRINITY 2, Basic Set, [KK.0044429](#)

Key features:
Five-axis fully stabilized hybrid camera stabilizer system, roll +/- 360°, tilt + 60°/-110°, payload up to 30 kg/66 lb, 12 V & 24 V high-capacity system power supply, LBUS, CAN Bus, tally and battery communication, 12G video, 12G reclocker, intuitive GUI and touch panel based remote controller, high-capacity battery management with battery communication, interchangeable BMS-2 battery mounts, optional wireless radio modules.

includes:
[K2.0042636](#) 1x TRH-2, TRINITY 2 Head, 16pin, X-Body
[K2.0042631](#) 1x TRH-2 Ring Main Cable, Standard, 0,65m/25.5in
[K2.0040347](#) 1x DUB-3, Dovetail Utility Base / 3
[K2.0041201](#) 1x Stabilizer Adapter Mount SAM-Zero
[K2.0039443](#) 1x Cam Pwr Gen.2, ALEXA 35, Mini, AMIRA, 24 V, 8-pin
[K2.0039448](#) 1x Cam Pwr Gen.2, 4-pin XLR, 12 V
[K2.0041984](#) 1x 12G HD SDI BNC Cable, 0,63m/25in
[K2.0010319](#) 1x ARTEMIS Docking Bracket, 1.8in
[K2.0040046](#) 1x CSS Post Tool for ARTEMIS and TRINITY
[O5.15642.0](#) 1x Hex Key 3mm/0.11in
[K2.0010493](#) 1x ARTEMIS Gimbal, Ø1.8in
[K2.0010569](#) 1x Gimbal Handle Extender for 1.8in Gimbal
[K2.0010489](#) 1x ARTEMIS Carbon Center Post, Ø1.8in
[K2.0040332](#) 1x Post Main Cable, 3B, 16pin
[K2.0038249](#) 1x TST-2, ARTEMIS Top Stage, Gen. 2, 16 pin
[K2.0037739](#) 1x BHM-2, Battery Hanger Module, Gen.2
[K2.0037771](#) 1x Power Cable, BHM-2 to TST, 12V, 24V, Bat. Data
[K2.0041327](#) 1x Support Rods 305mm, 12in, Ø19mm
[K2.0040790](#) 1x Support Rods 120mm, 4.7in, Ø19mm
[K2.0037757](#) 1x Hinge for Battery Hanger Module, Gen.2, Ø19mm
[K2.0039300](#) 2x BMS-2, Battery Mounting Base, Gen.2, (naked)
[K2.0036377](#) 1x TPD-2, TRINITY Pendulum Gen. 2
[K2.0033569](#) 4x Counterweight, CW-1, 150gr
[K2.0041090](#) 1x RCP-3, Remote Control Panel
[K2.0042837](#) 1x CSS Clamp Bridge 52, 19mm
[K2.0043883](#) 1x RCP-3, FS Can Bus Cable, 25cm/10in

NOTE
To complete the initial order, at least one of the mandatory battery mounting, joystick and monitor sets must be ordered. The customer can only put the system into operation if the basic set and the battery, joystick and monitor sets were ordered and delivered together.

Mandatory battery sets:
[K0.0044355](#), [K0.0044356](#), [K0.0044357](#)
 Mandatory joystick sets:
[K0.0044362](#), [K0.0044363](#)
 Mandatory monitor sets:
[K0.0048722](#), [K0.0048707](#), [K0.0048742](#)

Mandatory Battery Mounts

Gold Mount for BMS-1 / BMS-2, Set, includes: [K0.0044355](#)
 Gold Mount for BMS-1 / BMS-2 (2x) [K2.0040285](#)

V-Mount for BMS-1 / BMS-2, Set, includes: [K0.0044356](#)
 V-Mount for BMS-1 / BMS-2 (2x) [K2.0040286](#)

B-Mount for BMS-2, Set, includes: [K0.0044357](#)
 B-Mount for BMS-2 (2x) [K2.0040284](#)

B-Mount 12V for BMS-2,
[K2.0053830](#)

Mandatory Joysticks Sets

Master Grip TRINITY 2, One Controller Set [K0.0044362](#)
 includes:
 MGT-1, Master Grip Trinity-1, one controllers [K2.0041091](#)
 12G HD SDI BNC Cable, 0,63m/25in [K2.0041984](#)
 TRINITY 2 Joystick Cable, 75cm/29.5 in [K2.0043861](#)
 MTG Monitor Pwr, Lemo 0B, 2pin [K2.0038998](#)
 MTG Monitor Pwr, Lemo 0B, 5pin [K2.0038999](#)

Master Grip TRINITY 2, Two Controllers Set [K0.0044363](#)
 includes:
 MGT-2, Master Grip TRINITY 2, two controllers [K2.0041089](#)
 12G HD SDI BNC Cable, 0,63m/25in [K2.0041984](#)
 TRINITY 2 Joystick Cable, 75cm/29.5 in [K2.0043861](#)
 MTG Monitor Pwr, Lemo 0B, 2pin [K2.0038998](#)
 MTG Monitor Pwr, Lemo 0B, 5pin [K2.0038999](#)

Mandatory Monitor Sets

5in Transvideo Starlite Monitor Set, TRINITY 2, [K0.0048722](#)
 includes:
 Transvideo StarliteHD5-ARRI OLED Monitor [K2.0006960](#)
 Adapter ø19mm with 1/4in thread [K2.0048648](#)
 Articulating arm, 5in [K2.0048700](#)

5in Small HD Cine 5 Monitor Set, TRINITY 2, [K0.0048707](#)
 includes:
 SmallHD Cine 5 Monitor, 5in [K2.0048548](#)
 Adapter ø19mm with 1/4in thread [K2.0048648](#)
 Articulating arm, 5in [K2.0048700](#)

Universal Monitor Mounting Set, TRINITY 2, [K0.0048742](#)
 Includes:
 Adapter ø19mm with 1/4in thread [K2.0048648](#)
 Articulating arm, 5in [K2.0048700](#)

Adapter ø15mm with 1/4in thread, [K2.0048645](#)

Balance and Fibration-free Components



TRINITY 2 Essential Accessory Pro Set, [KK.0051462](#)
 includes:
[K2.0044225](#) 1x SSB-4, Stabilizer Systems Bracket 4
[K2.0047643](#) 1x NATO Accessory Rail NAR-30
[K2.0047771](#) 1x NATO Rail Clamp NRC-5
[K2.0041117](#) 1x Top Attachment Bracket TAB-1
[K2.0049835](#) 1x TAB-1-Extension
[K2.0042826](#) 2x 3/8-16 Extension
[K2.0033569](#) 4x Counterweight, CW-1, 150gr
[K2.0043875](#) 2x Counterweight CW-3, 50gr, 0.110 lbs
[K2.0043876](#) 2x Counterweight CW-4, 25gr, 0.055 lbs

TRINITY 2 Essential Accessory Kit, [KK.0049586](#) *
 includes:
[K2.0044225](#) 1x SSB-4, Stabilizer Systems Bracket 4
[K2.0041117](#) 1x Top Attachment Bracket TAB-1
[K2.0033852](#) 1x Accessory Rail Cube ARC-1
[K2.0042826](#) 2x 3/8-16 Extension
[K2.0033569](#) 4x Counterweight, CW-1, 150gr
[K2.0043875](#) 2x Counterweight CW-3, 50gr, 0.110 lbs
[K2.0043876](#) 2x Counterweight CW-4, 25gr, 0.055 lbs
[K2.0034009](#) 1x Accessory Rail Small ARS-2

19mm, 3/8 Extension, Steel, Set, [KK.0053621](#)
 includes:
[K2.0052729](#) 1x 19mm, 3/8, Extension, Steel, F-F
[K2.0052728](#) 1x 19mm, 3/8, Extension, Steel, M-F

TRINITY Skater
[K2.0049637](#)
 for easy balance

* discontinued - only as long as stock is available

TRINITY 2, TRINITY Gen. 1 - Compatible Accessories



Configuration Overview | 8.2.2 / 2025.02

TRINITY 2, TRINITY Gen. 1 - Balance



Pendulum Gen.2 Set, incl. Weights, [K0.0044361](#)
includes:
K2.0036377 1x TPD-2, TRINITY Pendulum Gen. 2
[K2.0033569](#) 4x Counterweight, CW-1, 150gr



Counterweight Set, 150 gr, 300 gr for SRH, TRINITY, MAXIMA, [KK.0033710](#)



Counterweight, CW-2, 300gr, 0,66 lbs, [K2.0033574](#)



Counterweight, CW-1, 150gr, 0,33 lbs, [K2.0033569](#)



Counterweight, CW-3, 50gr, 0.110 lbs, [K2.0043875](#)



Counterweight, CW-4, 25gr, 0.055 lbs, [K2.0043876](#)



3/8-16 Extension, [K2.0042826](#)



Counterweight Ring, Donut, 800 g, [K2.0031236](#)

TRINITY 2, TRINITY Gen. 1 - Brackets and Mounting



MSP-1, Multi Support Plate for TRINITY, [K2.0015385](#)



Clamp 3/8in for RAB-1, [K2.0047286](#)



Universal Monitor Mounting Set, TRINITY 2, [K0.0048742](#)



TRINITY 2 Essential Accessory Pro Set [KK.0051462](#)



Universal Post Clamp 1.8-1.5in, Gen. 2, [K2.0042719](#)



CSS Mitchell Mount, K2.0010427



CSS Euro Mount K2.0010426 *



ARTEMIS Knurled Handle Gimbal Extension, Ø1.8in, [K2.0014280](#)



CCB-2, CSS Clamp Bridge-2, 52, 19mm, [K2.0049885](#)



CSS Clamp Bridge 52, 19mm, [K2.0042837](#)



Stabilizer System Bracket SSB-1 for TRINITY, SAM plates, [K2.0035956](#)



SSB-4, Stabilizer Systems Bracket 4, [K2.0044225](#)



SSB-6, Stabilizer System Bracket 6, Basic Set [KK.0049354](#)



Rod Mounting Bracket RMB-5, K2.0014827



Rod Mounting Bracket RMB-6, K2.0020163



Rod Mounting Bracket RMB-3, K2.0006186



19mm, 3/8 Extension, Steel, Set, [KK.0053621](#)



DRW-1, Single Wheel, Mounting Set, [KK.0051464](#)

*** discontinued - only as long as stock is available**

Plates and Dovetails

for corresponding Plates and Dovetails please see Configuration Overview 8.3.2

Nato Rails

for further NATO Rails parts please see Configuration Overview 5.6.1

Camera-Top Mounting in TRINITY-Ring



Top Attachment Bracket TAB-1, [K2.0041117](#)



TAB-1-Extension [K2.0049835](#)

Controller for TRINITY 2



RCP-3, Remote Control Panel, K2.0041090



RCP-3, FS Can Bus Cable, 25cm/10in, [K2.0043883](#)

CSS Protection



Case TRINITY 2 compl. System, Pelican 1780, incl. Foam inlay, [K2.0048641](#)



Case TRINITY 2 compl. System, Pelican 1780, empty, [K2.0044439](#)



Case TRINITY 2 & ARTEMIS 2, Rig, SKB 3i-4217-7, [K2.0044440](#)



Foam Inlay TRINITY 2 compl. System, Pelican 1780 [K2.0048282](#)



Rain Cover Lower Sled [K2.0010466](#)



Case TRINITY Head, SKB 3i-2317-14BE, [K2.0016275](#)

TRINITY 2 - Pan Axis



Pan Axis for TRINITY 2, Set, [KK.0051466](#)

includes:
 K2.0050764 1x TRINITY 2 Pan Axis Module
[K2.0050770](#) 1x Communication Cable, TRINITY 2 Pan Axis
[K2.0040332](#) 1x Post Main Cable, 3B, 16pin
[K2.0019298](#) 1x SRH Mitchell Mount, Metric
[K2.0019302](#) 1x SRH FS CAN Bus Cable, 10m/32.8ft
[K2.0019306](#) 1x SRH High-Capacity Battery Power Cable, 12V/24V, 0.5m/1.64ft
[K2.0021427](#) 1x SRH High-Capacity Battery Power Cable 24V, 3-pin XLR, 10m/33ft
[K2.0021428](#) 1x SRH High-Capacity Battery Power Cable 12V, 4-pin XLR, 10m/33ft
[K2.0038756](#) 1x Wrench for SRH Castle Nut, Mitchell Mount

Power / Battery

for quick installation of the battery mount on 19 mm rods



BMS-3, Pro Set, V-Mount, [KK.0049408](#), includes:

K2.0048655 1x BMS-3, Battery Mounting Base naked
[K2.0040286](#) 1x V-Mount for BMS-1 / BMS-2
[K2.0042837](#) 1x CSS Clamp Bridge 52, 19mm
[K2.0036902](#) 1x ERM D-Tap Pwr Cable, 0B Lemo 2-pin to D-Tap, 1m/3.2ft
[K2.0021422](#) 1x 12V Battery Power Cable, D-Tab, 4-pin XLR, 1.5m/5ft

BMS-3, Pro Set, Gold-Mount, [KK.0049409](#), includes:

K2.0048655 1x BMS-3, Battery Mounting Base naked
[K2.0040285](#) 1x Gold Mount for BMS-1 / BMS-2
[K2.0042837](#) 1x CSS Clamp Bridge 52, 19mm
[K2.0036902](#) 1x ERM D-Tap Pwr Cable, 0B Lemo 2-pin to D-Tap, 1m/3.2ft
[K2.0021422](#) 1x 12V Battery Power Cable, D-Tab, 4-pin XLR, 1.5m/5ft

TRINITY 2 - Pan Axis Controller

EJS-1, EJW-1, Controller Set, [KK.0051502](#)

includes:
 K2.0049229 1x EJS-1, External Joystick, Broadcast
 K2.0049230 1x EJW-1, External Jog-Wheels
 K2.0006750 2x Cable LBUS - LBUS (0.3m/1ft)
[K2.0042837](#) 2x CSS Clamp Bridge 52, 19mm
 K2.0047854 1x NATO Accessory Rail NAR-60
 K2.0049419 1x NATO Rail Clamp NRC-3

EJS-1 Controller Set, [KK.0051103](#)

includes:
 K2.0049229 1x EJS-1, External Joystick, Broadcast
 K2.0006750 1x Cable LBUS - LBUS (0.3m/1ft)
[K2.0042837](#) 1x CSS Clamp Bridge 52, 19mm

EJW-1, Controller Set, [KK.0051102](#)

includes:
 K2.0049230 1x EJW-1, External Jog-Wheels
 K2.0006750 1x Cable LBUS - LBUS (0.3m/1ft)
[K2.0042837](#) 1x CSS Clamp Bridge 52, 19mm
 K2.0047854 1x NATO Accessory Rail NAR-60
 K2.0049419 1x NATO Rail Clamp NRC-3

ERM Sets



The external radio module offers reliable wireless communication over 2.4 GHz between the remote control and the Stabilized Remote Head 360 EVO and SRH-3 and SRH-360. The range of up to 1000 m/3280 ft. is based on so-called channel hopping.

ERM-2400 2.4 GHz RXD-TXD Basic Set, SRH, [KK.0040049](#)

includes:
[K2.0037428](#) 2x ERM-2400, SRH, Single Module
[K2.0033763](#) 2x ERM-2400 Rubber Duck Antenna
[K2.0033762](#) 2x SRH FS CAN Bus Cable, 1m/3.2ft
[K2.0033761](#) 1x ERM Power Cable, ERM-2400 & ERM-900

Range:
 Up to 1000 meter / 3280 ft.

further informations regarding ERM please see Config 8.5.0 & 8.5.1

TRINITY 2 - Pan Axis Controller

DRW-1 Digital Remote Wheel, Single Wheel Set, [KK.0051504](#), includes:

K2.0051132 1x DRW-1 Mounting Base 2
[KK.0021211](#) 1x DRW-1 Digital Remote Wheel, Third Wheel Set
[K2.0042837](#) 1x CSS Clamp Bridge 52, 19mm

DRW-1, Digital Remote Wheel, Single Wheel Set, 160mm, [KK.0053982](#), includes:

K2.0019319 1x DRW-1 Module
 K2.0051672 1x Hand Wheel 160 complete
 K2.0019318 1x DRW-1 Modul Mounting Bracket
 K2.0051132 1x DRW-1 Mounting Base 2
[K2.0042837](#) 1x CSS Clamp Bridge 52, 19mm

DEH-2 Pro Set, Left Zoom Rocker Master Grip, OCU-1, [K0.0048724](#), Includes:

[K2.0044672](#) 1x DEH-2, Digital Encoder Head 2
 K2.0020002 1x Operator Control Unit OCU-1 Basic Set
 K2.0020003 1x OCU-1 Rosette Bracket
 K2.0009490 1x Master Grip Left Rocker MLR-1
 K2.0048586 2x Cartoni special pan bar ø20mm
 K2.0012919 2x Handgrip Pan Bar Adapter 20mm
 K2.0006752 2x Cable LBUS - LBUS (0.8m/2.6ft)
 K2.0006753 2x Cable LBUS - LBUS (1.5m/5ft)

DEH-2 Pro Set, Right Zoom Rocker Master Grip, OCU-1, [K0.0048723](#)

Includes:
[K2.0044672](#) 1x DEH-2, Digital Encoder Head 2
 K2.0020002 1x Operator Control Unit OCU-1 Basic Set
 K2.0020003 1x OCU-1 Rosette Bracket
 K2.0009493 1x Master Grip Right Rocker MRR-1
 K2.0048586 2x Cartoni special pan bar ø20mm
 K2.0012919 2x Handgrip Pan Bar Adapter 20mm
 K2.0006752 2x Cable LBUS - LBUS (0.8m/2.6ft)
 K2.0006753 2x Cable LBUS - LBUS (1.5m/5ft)

TRINITY 2 - Pan Axis Mounting



RCP-3, Controller, 19mm Mounting Set, [KK.0051503](#)

includes:
[K2.0049453](#) 1x Mitchell Wedge Lock Set
[K2.0050433](#) 1x CSS Mitchell Base Plate
[K2.0049885](#) 2x CCB-2, CSS Clamp Bridge-2, 52, 19mm
 K2.0040791 1x Support Rods 430mm, 16.9in, Ø19mm



SSB-6, Stabilizer System Bracket 6, Basic Set, [KK.0049354](#)

includes:
 K2.0048349 1x SSB-6, Stabilizer Systems Bracket 6 extension
 K2.0048350 1x SSB-6, Stabilizer Systems Bracket 6



DRW-1, Single Wheel, Mounting Set, [KK.0051464](#)

includes:
 K2.0019318 1x DRW-1 Modul Mounting Bracket
 K2.0051132 1x DRW-1 Mounting Base 2
[K2.0042837](#) 1x CSS Clamp Bridge 52, 19mm



CSS Clamp Bridge 52, 19mm, [K2.0042837](#)



Monitor Adapter for Transvideo K2.0014831



Monitor Adapter for Small HD, K2.0014832



Rod Mounting Bracket RMB-3, K2.0006186

RCP-3



RCP-3, Remote Control Panel, K2.0041090



RCP-3, FS Can Bus Cable, 25cm/10in, [K2.0043883](#)

TRINITY 2 - Pan Axis Configuration



Configuration Overview | 8.2.4 / 2024.11

TRINITY 2 - Pan Axis



ERM Sets please see Config 8.5.0

SSB-6, Stabilizer Systems Bracket 6, K2.0048350



TRINITY 2 upgrade needed: Communication Socket Panel, TRINITY 2 Pan Axis Upgrade [K2.0050768](#)

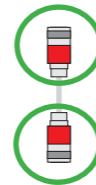

connections on the right side of the modules (Pan Axis -> TRINITY 2)

SRH FS CAN Bus Cable, 10m/32.8ft, [K2.0019302](#)

or / alternativ

SRH-3 FS CAN Bus Cable, 1m/3.2ft, [K2.0033762](#)

TRINITY 2 Pan Axis Module, K2.0050764

SRH Mitchell Mount, Metric [K2.0019298](#) included

Wrench for SRH Castle Nut, Mitchell Mount, [K2.0038756](#) included

external power option

- [K2.0050770](#) 1x Communication Cable, TRINITY 2 Pan Axis
- [K2.0040332](#) 1x Post Main Cable, 3B, 16pin
- [K2.0019302](#) 1x SRH FS CAN Bus Cable, 10m/32.8ft - Extension Cable
- [K2.0019306](#) 1x SRH High-Capacity Battery Power Cable, 12V/24V, 0.5m/1.64ft
- [K2.0021427](#) 1x SRH High-Capacity Battery Power Cable 24V, 3-pin XLR, 10m/33ft
- [K2.0021428](#) 1x SRH High-Capacity Battery Power Cable 12V, 4-pin XLR, 10m/33ft

Optional EXTENSION CABLES:
 SRH FS CAN Bus Cable, 1m/3.2ft, [K2.0033762](#)
 SRH FS CAN Bus Cable, 10m/32.8ft, [K2.0019302](#)
 SRH FS CAN Bus Cable, 25m/82ft, [K2.0019301](#)

Rod Mounting Bracket RMB-3, K2.0006186



SRH-3 FS CAN Bus Cable, 1m/3.2ft, [K2.0033762](#)

LBUS Cable

Operator Control Unit OCU-1 Basic Set, K2.0020002

or / alternativ

DRW-1 Digital Remote Wheel, Single Wheel Set, [KK.0051504](#)

or / alternativ

DEH-2 Pro Set, Left Zoom Rocker Master Grip, OCU-1, [K0.0048724](#)

DEH-2 Pro Set, Right Zoom Rocker Master Grip, OCU-1, [K0.0048723](#)

EJS-1, EJW-1, Controller Set, [KK.0051502](#)

or

EJS-1 Controller Set, [KK.0051103](#)

or

EJW-1, Controller Set, [KK.0051102](#)

LBUS Cable

RCP-3, Remote Control Panel, K2.0041090

RCP-3, Controller, 19mm Mounting Set, [KK.0051503](#)

BMS-3, Pro Set, V-Mount, [KK.0049408](#)

or

BMS-3, Pro Set, Gold-Mount, [KK.0049409](#)

Power/Battery Options - ARTEMIS & TRINITY



Configuration Overview | 8.3.0 / 2024.11

artemis Gen 1 / TRINITY Gen. 1

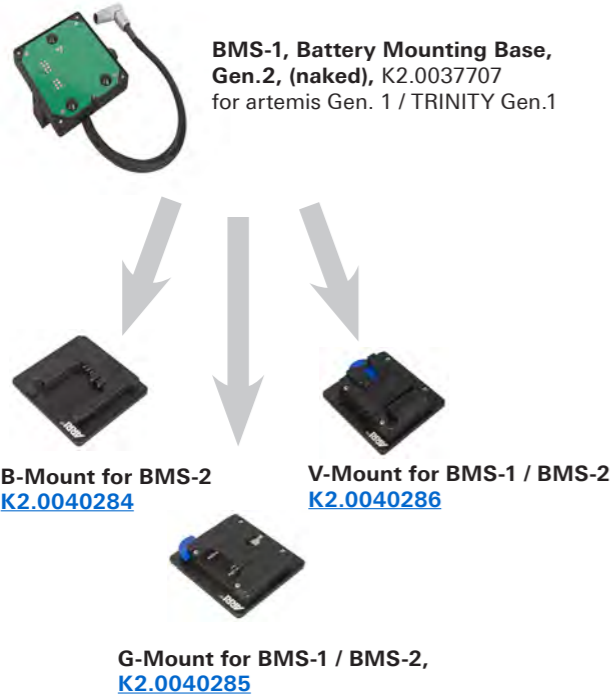

ARTEMIS 2 / TRINITY 2

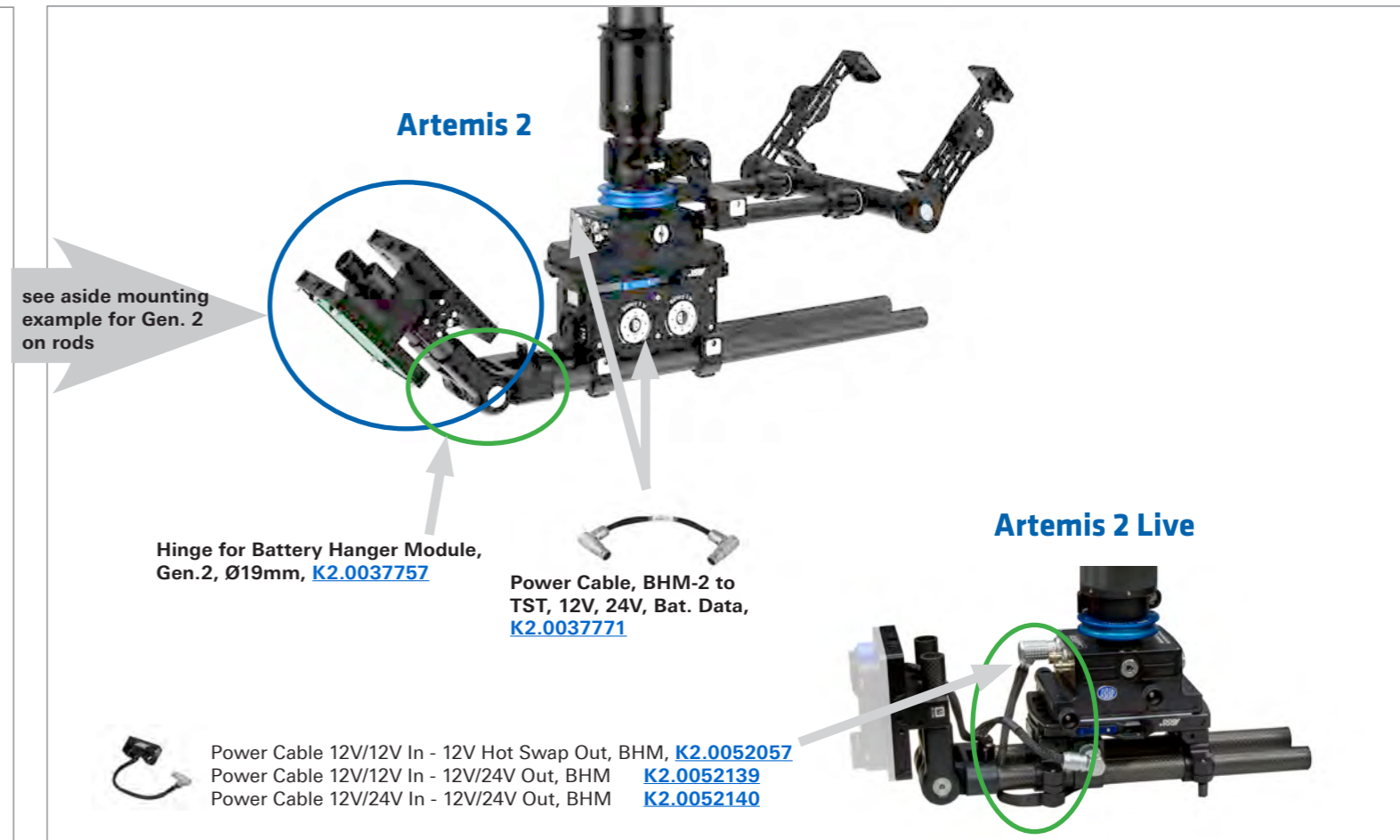
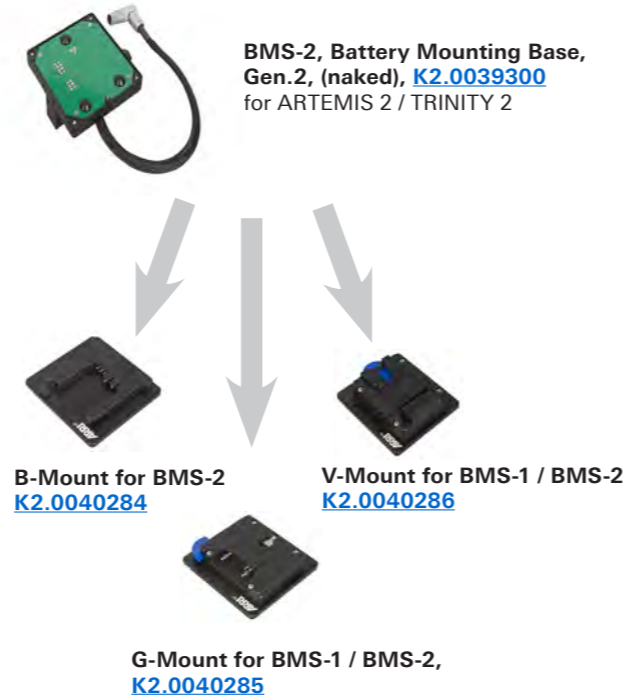

BMS-1 Upgrade Set, Gold Mount, incl. 3 Mounts, [K0.0044358](#) includes.
K2.0037707 3x BMS-1, Battery Mounting Base, Gen.2, (naked)
[K2.0040285](#) 3x Gold Mount for BMS-1 / BMS-2

BMS-1 Upgrade Set, V-Mount, incl. 3 Mounts, [K0.0044359](#) includes.
K2.0037707 3x BMS-1, Battery Mounting Base, Gen.2, (naked)
[K2.0040286](#) 3x V-Mount for BMS-1 / BMS-2

Brackets



19 mm Studio Rods

- Single Support Rod 540mm/21.3in, Ø19mm, K2.0014959, carbon fibre, black**
- Single Support Rod 340mm/13.4in, Ø19mm, K2.0014954, carbon fibre, black**
- Single Support Rod 150mm, 5.9in, Ø19mm, K2.0014961, stainless steel, lightweight**
- Single Support Rod 90mm, 3.5in, Ø19mm, K2.0014960, stainless steel, lightweight**
- Single Support Rod 76mm, 3in, Ø19mm, K2.0043811, carbon fibre, black**
- Support Rods 540mm/21.3in, Ø19mm, K2.72028.0, stainless steel**
- Support Rods 440mm/17.3in, Ø19mm, K2.0001022, stainless steel**
- Support Rods 430mm, 16.9in, Ø19mm, K2.0040791, carbon fibre, black**
- Support Rods 340mm/13.4in, Ø19mm, K2.66269.0, stainless steel, lightweight**
- Support Rods 305mm, 12in, Ø19mm, K2.0041327, carbon fibre, black**
- Support Rods 240mm/9.4in, Ø19mm, K2.66270.0, stainless steel, lightweight**
- Support Rods 150mm/5.9in, Ø19mm, K2.0016090, stainless steel, lightweight**
- Support Rods 120mm, 4.7in, Ø19mm, K2.0040790, carbon fibre, black**
- Support Rods 90mm/3.5in, Ø19mm, K2.0016088, stainless steel, lightweight**



ARTEMIS Arm Sets and Vest

SmartSystem ArmX1,
K2.0054618
For TRINITY 2, ARTEMIS, 2
Artemis 2 Live

SmartSystem ArmX1Lite +,
K2.0054619
For Artemis 2 Live

ARTEMIS Carbon Spring Arm, 23kg/50.7lb, Pro Set, range of payload 19-23 kg [KK.0020297](#)
Consists of:
ARTEMIS Carbon Spring Arm, 23kg/50.7lb K2.0010331
6 mm Hex Key 1/4" K2.0010435
4 mm Hex Key / 5/32" K2.0010434
Arm Soft Bag K2.0010463

ARTEMIS Carbon Spring Arm, 19kg/41.8lb, Pro Set, range of payload 15-19 kg [KK.0020296 *](#)

ARTEMIS Carbon Spring Arm, 26kg/57.3lb, Pro Set, range of payload 23-26 kg [KK.0020298 *](#)

ARTEMIS Carbon Spring Arm, 30kg/66.1lb, Pro Set, range of payload 26-30 kg [KK.0039452 *](#)

Rain Cover Spring Arm, [K2.0010465](#)

ARTEMIS Vest, [K2.0010333](#)

** discontinued - only as long as stock is available*

Configuration Arm

ARTEMIS Gimbal, Ø1.8in, [K2.0010493](#)

Arm Post 0,7 Volt Gimbl, [K2.0040244](#)

D-Bracket, 10in [K2.0010451](#)

Or

for Spring Arms:
Arm Post 10in, Ø 5,8in, K2.0010455 *
Arm Post 6in, Ø 5,8in, K2.0010453 *
Arm Post 3in, Ø 5,8in K2.0010454 *

** discontinued - only as long as stock is available*

ARTEMIS Vest, [K2.0010333](#)

ARTIMES Spring Arm Carbon

Configuration C-Stand

Docking Pin Sleeves for Tiffen Volt Gimbal, [K2.0049047](#)

ARTEMIS Gimbal, Ø1.8in, [K2.0010493](#)

ARTEMIS Docking Bracket, 1.8in, [K2.0010319](#)

for weight balance

parking position

C-stand with detachable Turtle Base, [K2.0010433](#)

or

Plates and Dovetails - ARTEMIS 2 / TRINITY 2 / 360 EVO



Configuration Overview | 8.3.2 / 2024.08

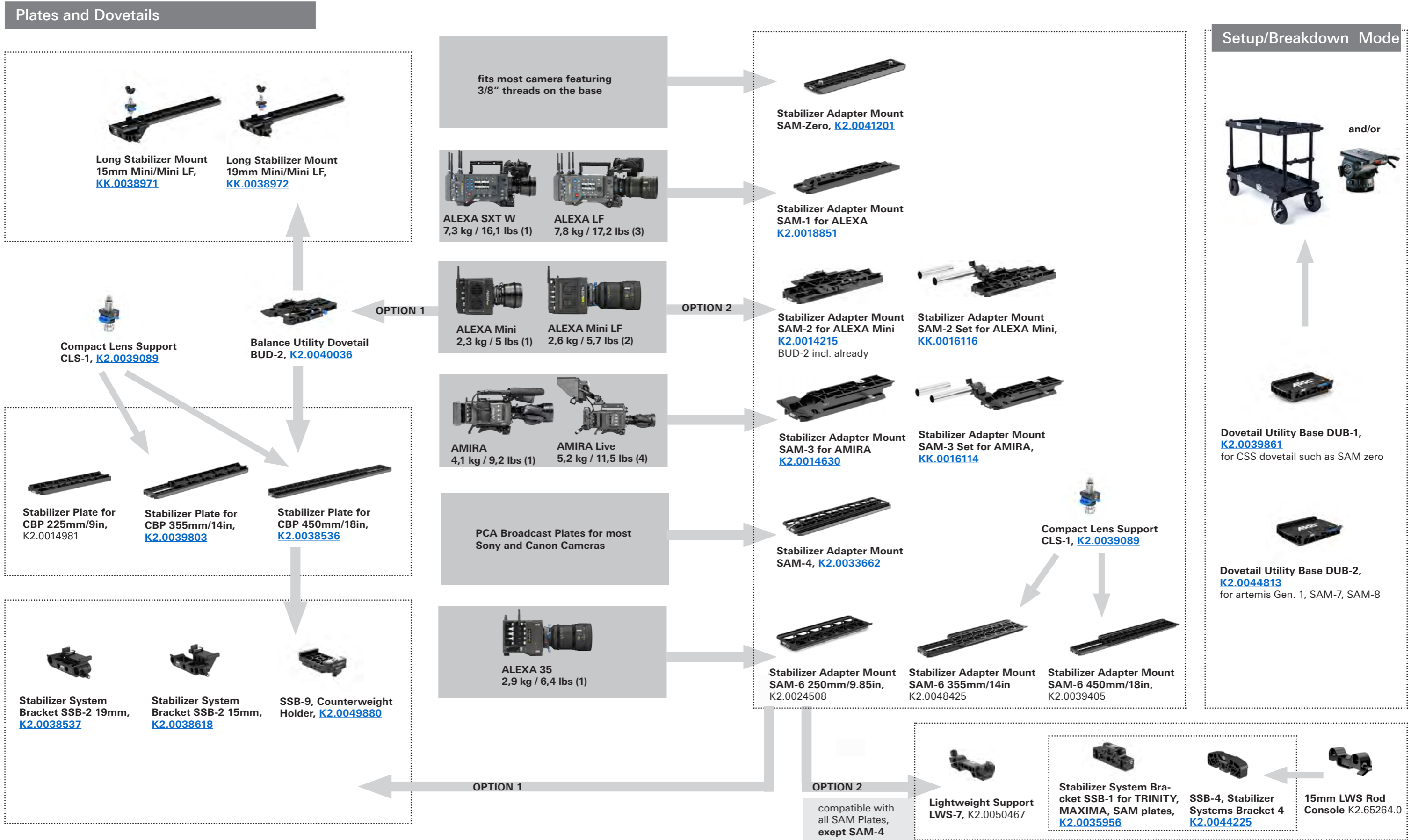

Stabilized Remote Head 360 EVO - Sets



Configuration Overview | 8.4.0 / 2025.02

Stabilized Remote Head EVO 360



360 EVO Basic Set, No Joystick, [KK.0050103](#)

Full-circle rotation on the roll axis. 360-degree rotation on the roll axis, revolving around the optical center of the lens, enables even more creativity for films, dramas, commercials, and music videos. Exceptionally dynamic roll-axis shots can be achieved by mounting the head to a crane, for example, or a cable cam above a live broadcast event.

- includes:
- K2.0049722 1x 360 EVO Stabilized Remote Head
 - K2.0049724 1x RCP-2 EVO Remote Control Panel
 - [K2.0041201](#) 1x Stabilizer Adapter Mount SAM-Zero
 - [K2.0039443](#) 1x Cam Pwr Gen.2, ALEXA 35, Mini, AMIRA, 24 V, 8-pin
 - [K2.0039448](#) 1x Cam Pwr Gen.2, 4-pin XLR, 12 V
 - [K2.0041984](#) 1x 12G HD SDI BNC Cable, 0,63m/25in
 - [K2.0019298](#) 1x SRH Mitchell Mount, Metric
 - [K2.0019302](#) 1x SRH FS CAN Bus Cable, 10m/32.8ft
 - [K2.0019306](#) 1x SRH High-Capacity Battery Power Cable, 12V/24V, 0.5m/1.64ft
 - [K2.0021427](#) 1x SRH High-Capacity Battery Power Cable 24V, 3-pin XLR, 10m/33ft
 - [K2.0021428](#) 1x SRH High-Capacity Battery Power Cable 12V, 4-pin XLR, 10m/33ft
 - [K2.0038756](#) 1x Wrench for SRH Castle Nut, Mitchell Mount
 - K2.0037206 2x 3/8in-16 Camera Screw
 - K2.0037205 1x 90° angled Hex Key 4mm
 - K2.0037207 1x Zip bag for tools
 - [K2.0042681](#) 1x TRH-2 Ring Main Cable, Long, 0,75m/29.5in
 - [K2.0049726](#) 1x Case 360 EVO Stabilized Remote Head

NOTE
The 360 EVO BASIC set does NOT include a joystick!
To complete the initial order, at least one of the mandatory joystick sets must be ordered.
Standard Joystick for SRH Remote Control Panel, RCP-2 ([K2.0039880](#)) Microforce Joystick for SRH Remote Control Panel, RCP-2 ([K2.0039882](#)) Broadcast Joystick for SRH Remote Control Panel, RCP-2 ([K2.0039881](#))

Mandatory Joysticks for RCP-2

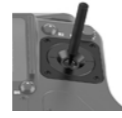

Standard Joystick for SRH Remote Control Panel, [K2.0039880](#)



Broadcast Joystick for SRH Remote Control Panel, [K2.0039881](#)



Microforce Joystick for SRH Remote Control Panel, [K2.0039882](#)



Focus Knob for SRH Remote Control Panel, [K2.0019291](#)

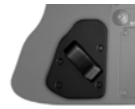

Zoom Rocker for SRH Remote Control Panel, [K2.0019292](#)



Additional Joystick for SRH Remote Control Panel, left side, [K2.0019290](#)



Focus / Zoom Set for SRH Remote Control Panel, [K0.0019595](#)



SRH Tripod Adapter Plate for SRH Remote Control, [K2.0019293 *](#)

Radio Sets



ERM-2400 2.4 GHz RXD-TXD Pro Set, SRH, [KK.0040049](#)



ERM-2400 Ext 2.4 GHz RXD-TXD Pro Set LCS, [KK.0040048](#)



ERM-900 MHz RXD-TXD Pro Set, SRH, [KK.0040050](#)

For more details see Configuration Overview 8.6.0 & 8.6.1

Optional Controllers



DEH-2 Pro Set, Right Zoom Rocker Master Grip, OCU-1, [K0.0048723](#)

- Includes:
- [K2.0044672](#) 1x DEH-2, Digital Encoder Head 2
 - K2.0020002 1x Operator Control Unit OCU-1 Basic Set
 - K2.0020003 1x OCU-1 Rosette Bracket
 - K2.0009493 1x Master Grip Right Rocker MRR-1
 - K2.0048586 2x Cartoni special pan bar ø20mm
 - K2.0012919 2x Handgrip Pan Bar Adapter 20mm
 - K2.0006752 2x Cable LBUS - LBUS (0.8m/2.6ft)
 - K2.0006753 2x Cable LBUS - LBUS (1.5m/5ft)

DEH-2 Pro Set, Left Zoom Rocker Master Grip, OCU-1, [K0.0048724](#)



DEP-1, Digital Encoder Pedal, Pro Set, [K0.0039160](#)

- includes:
- K2.0039147 1x DEP-1, Host Pedal
 - K2.0039149 1x DEP-1, Client Pedal
 - K2.0001637 1x Cable RS - RS/PWR IN (0.5m/1.6ft)



DEH-1 Digital Encoder Head, [K2.0022594](#)



DEH-2, Digital Encoder Head 2, [K2.0044672](#)

Bracket for Controller



SSB-7, Stabilizer System Bracket 7, DEH-2 Set, [KK.0049407](#)

- Special Counterweight Bracket for the DEH-2
- includes:
- K2.0048281 1x Stabilizer System Bracket SSB-7
 - [K2.0043811](#) 2x Single Support Rod 76mm, 3in, Ø19mm
 - K2.0048587 2x Cartoni Counterweights Rod ø22mm, 2x0,5kg

- Recommended accessories:
- BMS-3, Pro Set, V-Mount ([KK.0049408](#))
 - BMS-3, Pro Set, Gold-Mount ([KK.0049409](#))
 - Multicam Monitor bundle VMM-1 & MYS-1 (K0.0039106)



EJS-1, EJW-1, Controller Set, [KK.0051502](#)

- includes:
- K2.0049229 1x EJS-1, External Joystick, Broadcast
 - K2.0049230 1x EJW-1, External Jog-Wheels
 - K2.0006750 2x Cable LBUS - LBUS (0.3m/1ft)
 - [K2.0042837](#) 2x CSS Clamp Bridge 52, 19mm
 - K2.0047854 1x NATO Accessory Rail NAR-60
 - K2.0049419 1x NATO Rail Clamp NRC-3



EJW-1, Controller Set, [KK.0051102](#)

- includes:
- K2.0049230 1x EJW-1, External Jog-Wheels
 - K2.0006750 1x Cable LBUS - LBUS (0.3m/1ft)
 - [K2.0042837](#) 1x CSS Clamp Bridge 52, 19mm
 - K2.0047854 1x NATO Accessory Rail NAR-60
 - K2.0049419 1x NATO Rail Clamp NRC-3



DRW-1 Digital Remote Wheel, Single Wheel Set, [KK.0051504](#)

- includes:
- K2.0051132 1x DRW-1 Mounting Base 2
 - [KK.0021211](#) 1x DRW-1 Digital Remote Wheel, Third Wheel Set
 - [K2.0042837](#) 1x CSS Clamp Bridge 52, 19mm

DRW-1, Digital Remote Wheel, Single Wheel Set, 160mm, [KK.0053982](#), includes:

- K2.0019319 1x DRW-1 Module
- K2.0051672 1x Hand Wheel 160 complete
- K2.0019318 1x DRW-1 Modul Mounting Bracket
- K2.0051132 1x DRW-1 Mounting Base 2
- [K2.0042837](#) 1x CSS Clamp Bridge 52, 19mm



RCP-3, Controller, 19mm Mounting Set, [KK.0051503](#)

- includes:
- [K2.0049453](#) 1x Mitchell Wedge Lock Set
 - [K2.0050433](#) 1x CSS Mitchell Base Plate
 - [K2.0049885](#) 2x CCB-2, CSS Clamp Bridge-2, 52, 19mm
 - K2.0040791 1x Support Rods 430mm, 16.9in, Ø19mm

* discontinued - only as long as stock is available

Stabilized Remote Head 360 EVO - Accessories & Upgrade Sets



Configuration Overview | 8.4.1 / 2025.06

Balance and Fibration-free Components / Mounting Options Flate Base



Vibration Isolator for SRH, Gen. 2, Metric, Basic Set, [KK.0039359](#)

includes:
K2.0038752 1x Vibration Isolator for SRH, Gen. 2, Metric
[K2.0024106](#) 1x SRH Mitchell Mount Castle Nut, Metric
[K2.0038756](#) 1x Wrench for SRH Castle Nut, Mitchell Mount
[K2.0038758](#) 1x Case for Vibration Isolator for SRH, Gen 2

Vibration Isolator for SRH, Gen. 2, Imperial, Basic Set, [KK.0041936](#)

includes:
K2.0041912 1x Vibration Isolator for SRH, Gen. 2, imperial
[K2.0041922](#) 1x SRH Mitchell Mount Castle Nut, Imperial
[K2.0038756](#) 1x Wrench for SRH Castle Nut, Mitchell Mount
[K2.0038758](#) 1x Case for Vibration Isolator for SRH, Gen 2



SRH Modular Low Mount Rack, [K2.0024658](#) *

* discontinued - only as long as stock is available



SRH Mitchell Mount Castle Nut, metric, [K2.0024106](#)
imperial, [K2.0041922](#)



Wrench for SRH Castle Nut, Mitchell Mount, [K2.0038756](#)



SRH Mitchell Mount Collar, 45mm / 1.77in, [K2.0019297](#)



SRH Mitchell Mount Collar, 40mm / 1.57in, Metric, [K2.0024108](#)



Mitchell Wedge Lock Set [K2.0049453](#)



CSS Euro Mount [K2.0010426](#) *

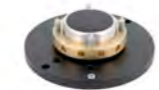

SRH Mitchell Mount, Metric [K2.0019298](#)



CSS Mitchell Base Plate, [K2.0050433](#)

Top-Stabilization in Ring



Top Attachment Bracket TAB-1, [K2.0041117](#)



TAB-1-Extension [K2.0049835](#)



SSB-4, Stabilizer Systems Bracket 4 [K2.0044225](#)

Power / Battery

for quick installation of the battery mount on 19 mm rods



BMS-3, Pro Set, V-Mount, [KK.0049408](#)

includes:
K2.0048655 1x BMS-3, Battery Mounting Base naked
[K2.0040286](#) 1x V-Mount for BMS-1 / BMS-2
[K2.0042837](#) 1x CSS Clamp Bridge 52, 19mm
[K2.0036902](#) 1x ERM D-Tap Pwr Cable, 0B Lemo 2-pin to D-Tap, 1m/3.2ft
[K2.0021422](#) 1x 12V Battery Power Cable, D-Tab, 4-pin XLR, 1,5m/5ft



BMS-3, Pro Set, Gold-Mount, [KK.0049409](#)

includes:
K2.0048655 1x BMS-3, Battery Mounting Base naked
[K2.0040285](#) 1x Gold Mount for BMS-1 / BMS-2
[K2.0042837](#) 1x CSS Clamp Bridge 52, 19mm
[K2.0036902](#) 1x ERM D-Tap Pwr Cable, 0B Lemo 2-pin to D-Tap, 1m/3.2ft
[K2.0021422](#) 1x 12V Battery Power Cable, D-Tab, 4-pin XLR, 1,5m/5ft

Network Communication



CSS IP-Box Set, TX / RX, [K2.0052050](#)

RCP-3, FS Can Bus Cable, 25cm/10in, [K2.0043883](#)
SRH FS CAN Bus Cable, 10m/32.8ft, [K2.0019302](#)
SRH FS CAN Bus Coupler, 0.2m/0.65ft, [K2.0019300](#)
Monitor Power, 12V, Lemo 0B 2-pin to 0B 2-pin, [K2.0041723](#)
ERM D-Tap Pwr Cable, 0B Lemo 2-pin to D-Tap, 1m/3.2ft, [K2.0036902](#)

Cable



SRH FS CAN Bus Cable, 25m/82ft, [K2.0019301](#)
SRH FS CAN Bus Cable, 10m/32.8ft, [K2.0019302](#)
SRH FS CAN Bus Cable, 1m/3.2ft, [K2.0033762](#)



SRH FS CAN Bus Coupler, 0.2m/0.65ft, [K2.0019300](#)



SRH High-Capacity Battery Power Cable 24V, 3-pin XLR, 10m/33ft, [K2.0021427](#)
SRH High Capacity Battery Power Cable 12V, 4pin XLR, 10m/33ft, [K2.0021428](#)
SRH High Capacity Battery Power Cable 24V, 3pin XLR, 20m/66ft, [K2.0021429](#)
SRH High Capacity Battery Power Cable 12V, 4pin XLR, 20m/66ft, [K2.0021430](#)
SRH High-Capacity Battery Power Cable, 12V/24V, 0.5m/1.64ft, [K2.0019306](#)

CSS Accessories



Counterweight Set, 150 g, 300 g, [KK.0033710](#)



SRH Side Accessory Mounting Bracket, [K2.0019296](#) *



SRH Side Brackets for Remote Control Panel, [K2.0019289](#) *



SRH Tripod Adapter Plate for SRH Remote Control, [K2.0019293](#) *



SRH Rod Support Set, [K2.0033426](#)



SRH Top Support Bracket, [K2.0019727](#)



SSB-4, Stabilizer Systems Bracket 4, [K2.0044225](#)



RCP-2 Rod Mounting Adapter, 19mm, cmpl., [KK.0052698](#)

includes:
K2.0052699 1x RCP-2-Rod Mounting Adapter, incl. Screws
[K2.0042837](#) 2x CSS Clamp Bridge 52, 19mm

* discontinued - only as long as stock is available

Cable for large Camera Setup



TRH-2 Ring Main Cable, Standard, 0,65m/25.5in, [K2.0042631](#)

TRH-2 Ring Main Cable, Long, 0,75m/29.5in, [K2.0042681](#)

Protection



Case 360 EVO Stabilized Remote Head, [K2.0049726](#)



Rain Cover 360 EVO & SRH-3 & SRH-360, [K2.0043054](#)



Case for DEH-2, [K2.0048588](#)



Case for Vibration Isolator for SRH, Gen 2, [K2.0038758](#)

360 EVO Stabilized Remote Head - Sample Configuration Cine



Configuration Overview | 8.4.2 / 2025.06

Cine Configuration

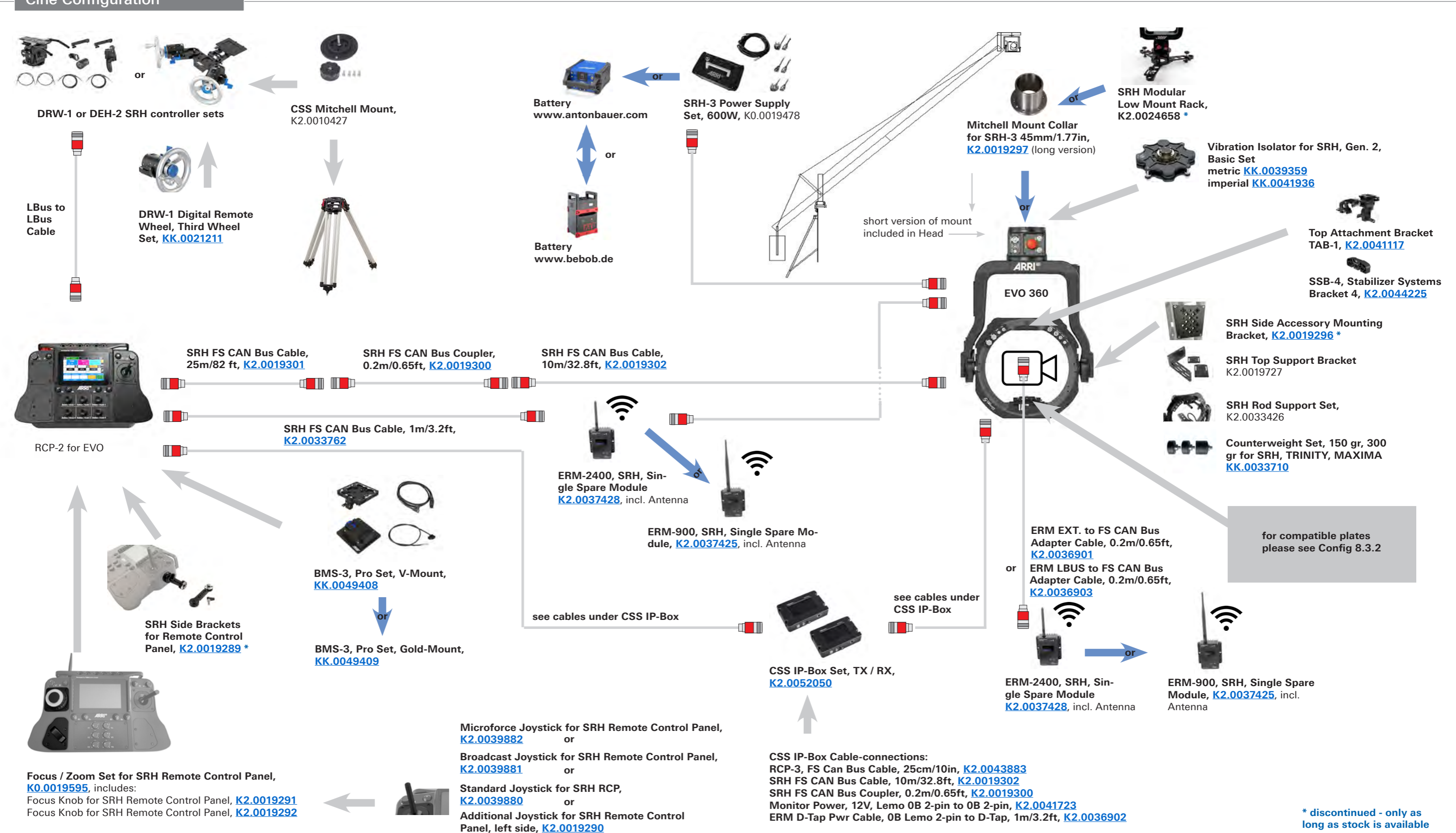

360 EVO Stabilized Remote Head - Sample Configuration Live Production



Configuration Overview | 8.4.3 / 2025.06

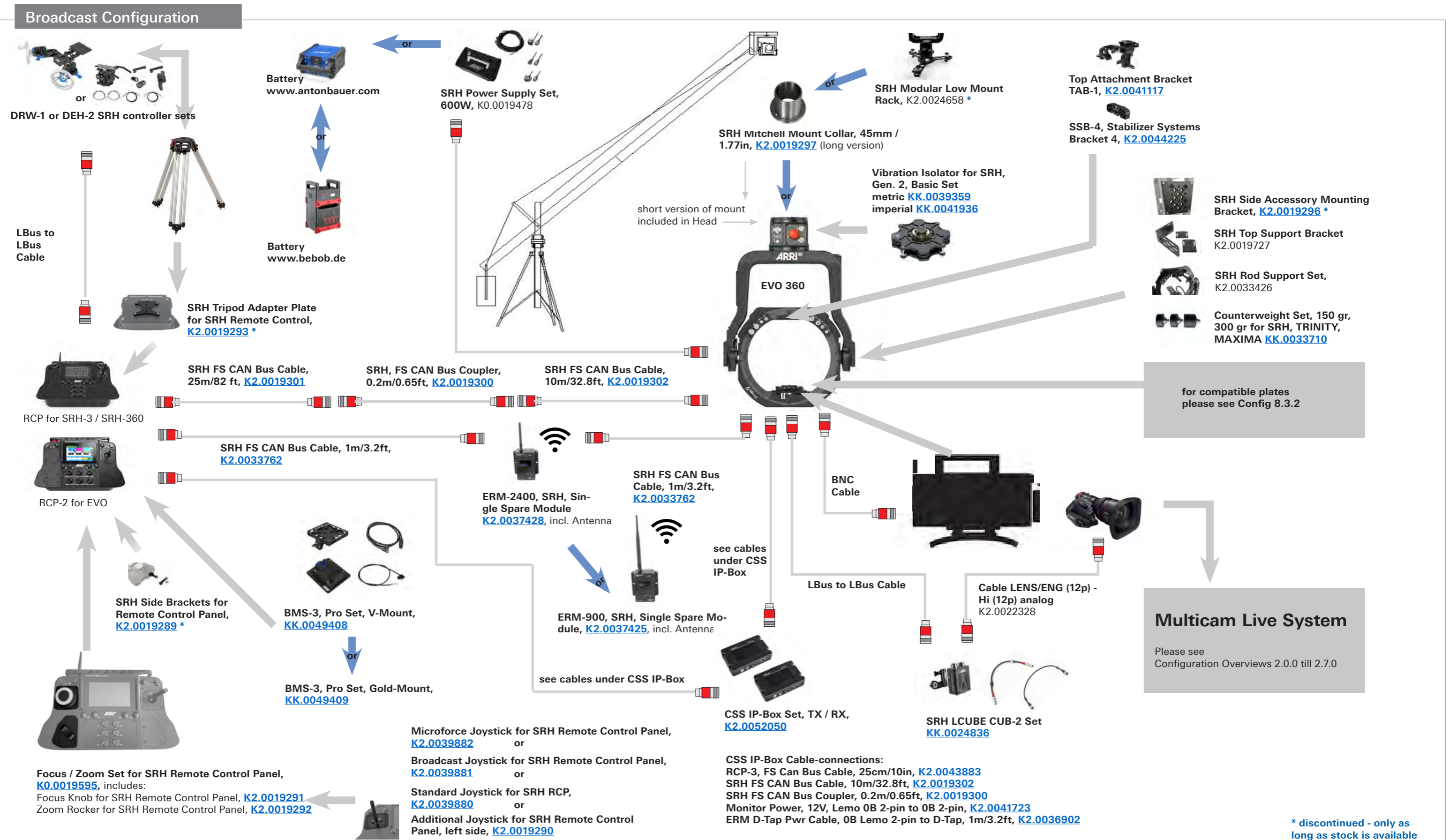

360 EVO Stabilized Remote Head - Setup Cine Style Network



Configuration Overview | 8.4.4 / 2025.09

ARRI Cameras with LBUS

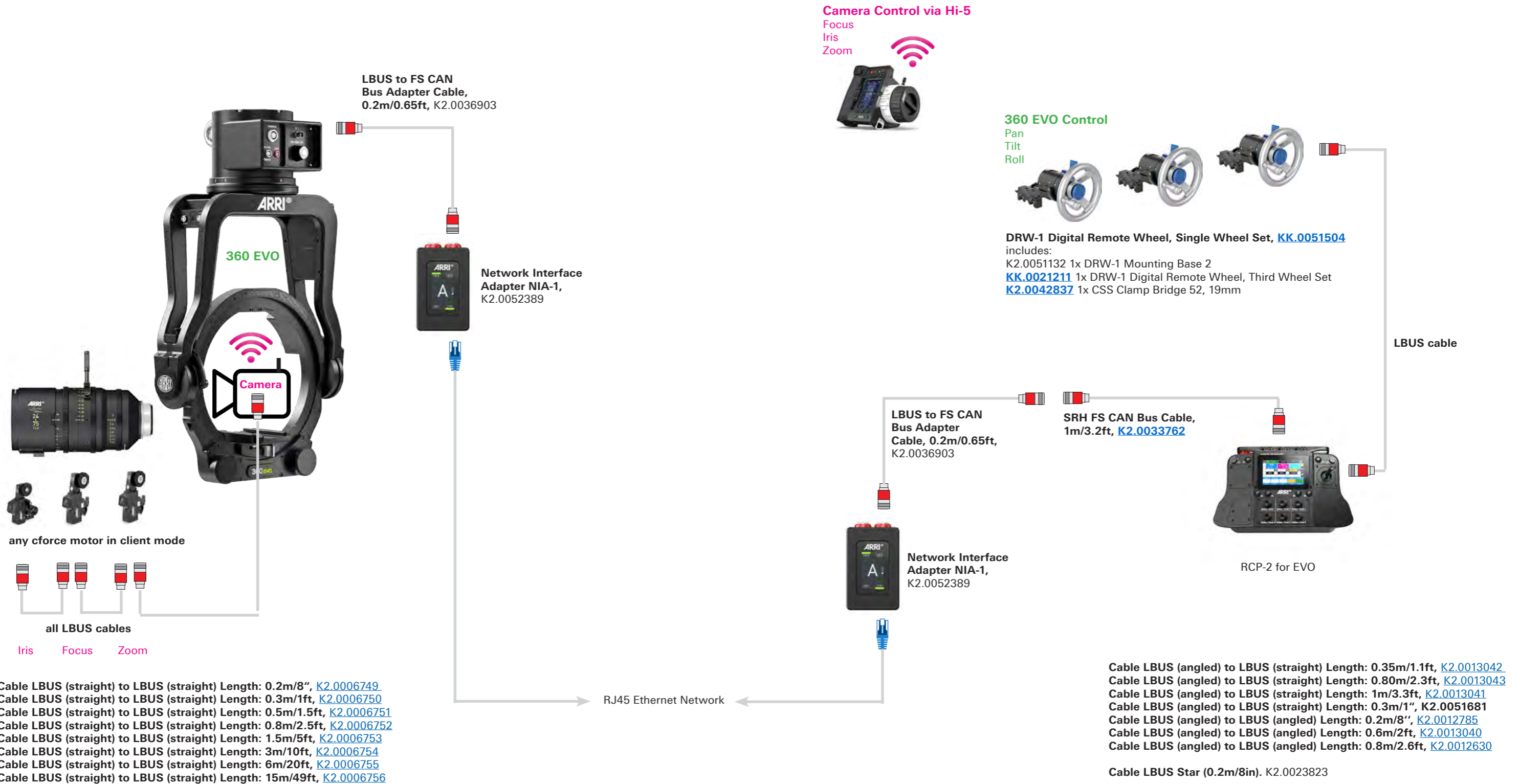

External Radio Module ERM - TRINITY 2 / 360 EVO



Configuration Overview | 8.5.0 / 2024.11

TRINITY 2, EVO 360 - for tilt/pan/roll axis of the head



The external radio module offers reliable wireless communication over 2.4 GHz between the remote control and the Stabilized Remote Head 360 EVO and SRH-3 and SRH-360. The range of up to 1000 m/3280 ft. is based on so-called channel hopping.

ERM-2400 2.4 GHz RXD-TXD Basic Set, SRH, [KK.0040049](#)

- includes:
- [K2.0037428](#) 2x ERM-2400, SRH, Single Module
 - [K2.0033763](#) 2x ERM-2400 Rubber Duck Antenna
 - [K2.0033762](#) 2x SRH FS CAN Bus Cable, 1m/3.2ft
 - [K2.0033761](#) 1x ERM Power Cable, ERM-2400 & ERM-900

Range:
Up to 1000 meter / 3280 ft.



The external radio module offers reliable wireless communication over 900 MHz between the remote control and the Stabilized Remote Head 360 EVO and SRH-3 and SRH-360. The range of up to 3000 m/6560 ft. is based on so-called channel hopping.

ERM-900 MHz RXD-TXD Basic Set, SRH, [KK.0040050](#)

- includes:
- [K2.0037425](#) 2x ERM-900, SRH, Single Module
 - [K2.0033765](#) 2x ERM-900 Rubber Duck Antenna
 - [K2.0033762](#) 2x SRH FS CAN Bus Cable, 1m/3.2ft
 - [K2.0033761](#) 1x ERM Power Cable, ERM-2400 & ERM-900

Range:
Up to 3000 meter / 6560 ft

certified only for use in USA and Canada



ERM-2400 Rubber Duck Antenna, [K2.0033763](#)



ERM-2400, SRH, Single Spare Module [K2.0037428](#), incl. Antenna



ERM-900 Rubber Duck Antenna, [K2.0033765](#)



ERM-900, SRH, Single Spare Module, [K2.0037425](#), incl. Antenna

Wireless LCS/LBUS/EXT Connection



An ERM-2400 LCS set of radio modules basically extends an LCS/LBUS/EXT (CAN bus) cable connection over air. As such, it can connect ARRI and motion hand units to cameras and motor controllers and they behave as if they were hardwired, but with an exceptionally great wireless range (up to 1,000 m/3,280 ft).

ERM-2400 Ext 2.4 GHz RXD-TXD Pro Set LCS, [KK.0040048](#)

- includes:
- [K2.0037440](#) 2x ERM-2400, LCS, Single Module
 - [K2.0033763](#) 2x ERM-2400 Rubber Duck Antenna
 - [K2.0036900](#) 2x ERM LCS to FS CAN Bus Adapter Cable, 0.2m/0.65ft
 - [K2.0036903](#) 2x ERM LBUS to FS CAN Bus Adapter Cable, 0.2m/0.65ft
 - [K2.0036901](#) 1x ERM EXT. to FS CAN Bus Adapter Cable, 0.2m/0.65ft
 - [K2.0036902](#) 1x ERM D-Tap Pwr Cable, 0B Lemo 2pin to D-Tap, 1m/3.2ft
 - [K2.0033762](#) 2x SRH FS CAN Bus Cable, 1m/3.2ft

Note:
The basic set is only supplied with adapter cables.

Recommended and required optional extension cables:

- SRH FS CAN Bus Cable, 10m/32.8ft [K2.0019302](#)
- SRH FS CAN Bus Cable, 25m/82ft [K2.0019301](#)
- SRH FS CAN Bus Coupler, 0.2m/0.65ft [K2.0019300](#)



ERM-2400 Rubber Duck Antenna, [K2.0033763](#)



ERM-2400, LCS, Single Spare Module, [K2.0037440](#), incl. Antenna coupling through ARRI Service

TRINITY 2 - RCP communication



TRINITY RF-2400 Radio Set, [K0.0044373](#)



TRINITY RAT-1 Radio Adapter Set, [K0.0047466](#)

Cables



ERM LCS to FS CAN Bus Adapter Cable 0.2m/0.65ft [K2.0036900](#)



ERM LBUS to FS CAN Bus Adapter Cable, 0.2m/0.65ft [K2.0036903](#)



ERM EXT. to FS CAN Bus Adapter Cable, 0.2m/0.65ft [K2.0036901](#)



ERM D-Tap Pwr Cable, 0B Lemo 2-pin to D-Tap, 1m/3.2ft, [K2.0036902](#)



- Required optional extension cables:
- SRH FS CAN Bus Cable, 0,3m/0.98ft, [K2.0037788](#)
 - SRH FS CAN Bus Cable, 1m/3.2ft, [K2.0033762](#)
 - SRH FS CAN Bus Cable, 5m/16.4ft, [K2.0037701](#)
 - SRH FS CAN Bus Cable, 10m/32.8ft, [K2.0019302](#)
 - SRH FS CAN Bus Cable, 25m/82ft, [K2.0019301](#)

LCS Configuration Samples

For Configuration Sample with the Lens Control System please also see [Configuration Overview 4.7.0 till 4.7.2](#)

EVO Configuration Samples

For Configuration Sample with the EVO 360, SRH-360 & SRH-3 System please also see [Configuration Overview 8.4.2 & 8.4.3 & 8.5.1](#)

Mounting Bracket ERM



Rod Mounting Bracket RMB-3, [K2.0006186](#)

External Radio Module ERM - Sample Configurations for CSS



Configuration Overview | 8.5.1 / 2024.08

Stabilized Remote Head with ERM SRH

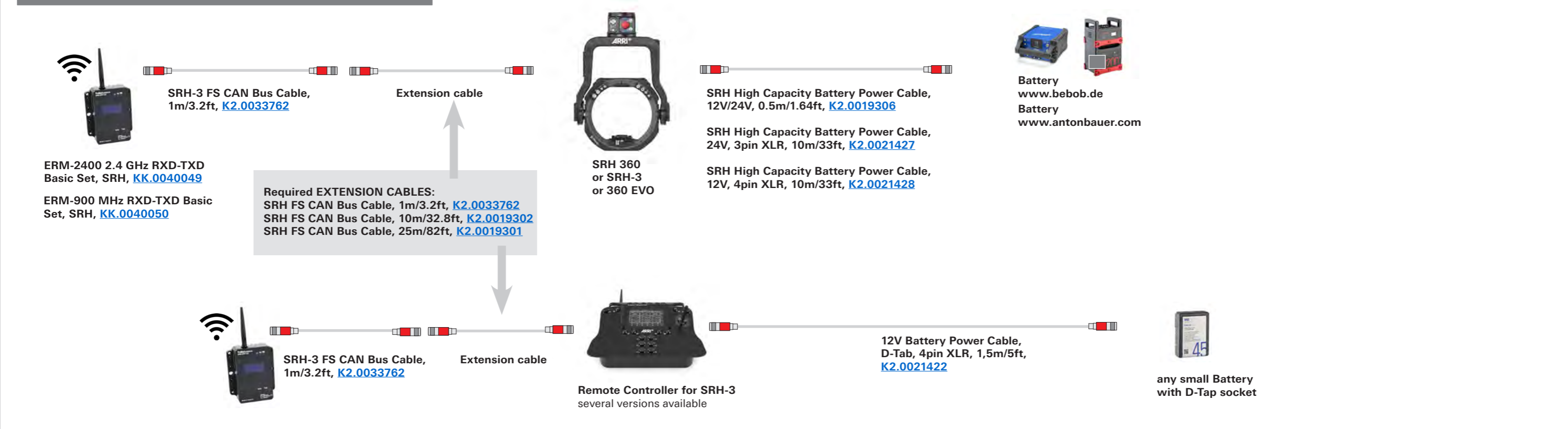

Digital Encoder Head or Wheels with ERM LCS

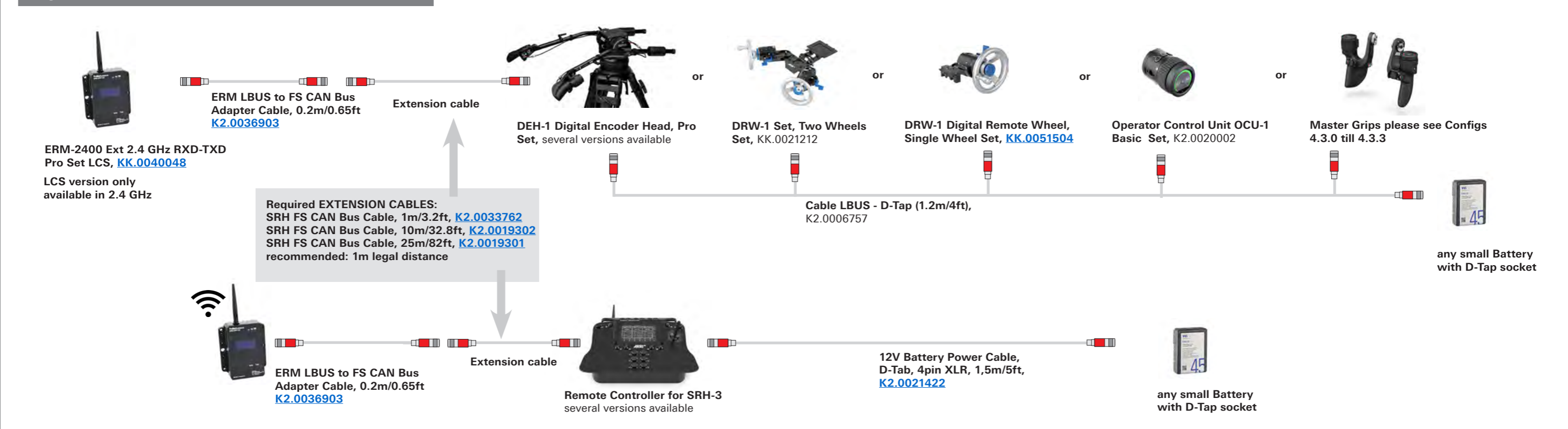

Stabilizer System - Cable Guide 1



Configuration Overview | 8.6.0 / 2024.11

Item Number	Cable Name	Supported Cameras	Artemis 1	Artemis 2	TRINITY 1	TRINITY 2	360 EVO
K2.0039443	Cam Pwr Gen.2, ALEXA 35, Mini, AMIRA, 24 V, 8-pin	Tally Sensor Cable can be used with the first and second generation of the Tally system.	X	✓	X	✓	✓
K2.0039446	Cam Pwr Gen. 2, Alexa LF, 24V, 2-pin Fischer	24V high-capacity camera power cable. Lemo 2B 7-pin to Fischer 2-pin, 0.7m / 2.3ft	X	✓	X	✓	✓
K2.0039447	Cam Pwr Gen.2, ALEXA Mini, AMIRA, 12 V, 8-pin	12V high-capacity camera power cable. Lemo 2B 7-pin to Lemo 2B 8-pin, 0.7m / 2.3ft	X	✓	X	✓	✓
K2.0040329	Cam Pwr Gen. 2, 4 pin XLR, 12V, 90° elbow	12V high-capacity camera power cable. Lemo 2B 7-pin to XLR 4-pin, 90° elbow, 0.7m / 2.3ft	X	✓	X	✓	✓
K2.0039448	Cam Pwr Gen.2, 4-pin XLR, 12 V	12V high-capacity camera power cable. Lemo 2B 7-pin to XLR 4-pin, 0.7m / 2.3ft	X	✓	X	✓	✓
K2.0039449	Cam Pwr Gen.2, RED Monstro, 12 V	12V high-capacity camera power cable. Lemo 2B 7-pin to Lemo 1B 6-pin, 0.7m / 2.3ft	X	✓	X	✓	✓
K2.0039450	Cam Pwr Gen.2, RED Ranger, 24 V	24V high-capacity camera power cable. Lemo 2B 7-pin to Lemo 2B 4-pin, 0.7m / 2.3ft	X	✓	X	✓	✓
K2.0039451	Cam Pwr Gen.2, SONY Venice, 4-pin XLR, 24 V	24V high-capacity camera power cable. Lemo 2B 7-pin to XLR 4-pin, 0.7m / 2.3ft	X	✓	X	✓	✓
K2.0010470	Cam Power, Cine, 12 V, XLR, HiCap	12 V XLR high-capacity camera power cable, Lemo 1B 4-pin to XLR 4-pin, for video cameras, ARRIFLEX 16SR I, ARRI 16SR II, Aaton and other devices using a 4-pin XLR socket. LEMO 4-pin, 12V, high capacity	✓	✓	✓	✓	X
K2.0037771	Power Cable, BHM-2 to TST, 12V, 24V, Bat. Data	High-capacity 12 V/24 V power cable to connect the Battery Hanger Module with the Top Stage or Bottom Stage Gen.2. Lemo 2B 7-pin to Lemo 2B 7-pin, 12V/24V	X	not for Artemis 2 Live ✓	X	✓	X
K2.0048481	BHM-2 to TRH-2 Ext. Pwr, 7pin, 2m / 6.5ft	This external power cord allows the TRINITY 2 head to be powered when used as a standalone stabilizer mounted on the MSP-1 (K2.0015385) through the Battery Hanger Module (BHM-2), which was also detached from the rig. Lemo 2B 7pin - Length: 2m / 6.5ft	X	✓	X	✓	X

Stabilizer System - Cable Guide 2



Configuration Overview | 8.6.1 / 2024.08

Item Number	Cable Name	Supported Cameras	Artemis 1	Artemis 2	TRINITY 1	TRINITY 2	360 EVO
K2.0010546	Monitor Power, 12V, Lemo 0B 2-pin	12V monitor power cable. Lemo 0B 2-pin to XLR 4-pin, 12V.	✓	✓	✓	✓	✓
K2.0041723	Monitor Power, 12V, Lemo 0B 2-pin to 0B 2-pin	Short 12 V power cable to power a second Transvideo Starlite or SmallHD monitor from the Tally System Gen.2 host module. Lemo 0B 2-pin to Lemo 0B 2-pin, 12V	✓	✓	✓	✓	✓
K2.0021422	12V Battery Power Cable, D-Tab, 4-pin XLR, 1,5m/5ft	12 V power cable to power the 360 EVO, SRH-3 and SRH-360 remote control panel, or a monitor via D-Tab. D-Tab to 4-pin XLR, 1,5m/5ft, 12V. For Remote Control Panel (RCP-2) of the 360 EVO, SRH-3 and SRH-360	✓	✓	✓	✓	✓
K2.0038998	MTG Monitor Pwr, Lemo 0B, 2-pin	Power cable to power a Transvideo Starlight, or SmallHD 503 monitor from the Master Grip TRINITY 2. Lemo 0B 4-pin to Lemo 0B 2-pin, 24V. For MGT-1, MGT-2, TRINITY 2	✗	✗	✓ after LBUS upgrade	✓	✗
K2.0038999	MTG Monitor Pwr, Lemo 0B, 5-pin	Power cable to power a ARRI Starlite monitor from the Master Grip TRINITY 2. Lemo 0B 4-pin to Lemo 0B 5-pin, 24V. For MGT-1, MGT-2, TRINITY 2	✗	✗	✓ after LBUS upgrade	✓	✗
K2.0043861	TRINITY 2 Joystick Cable, 75cm/29.5in	Flexible joystick cable to connect Master Grip TRINITY with the TRINITY 2 head. Lemo 0B 4-pin to Lemo 0B 4-pin, 24V, 75cm/29.5in	✗	✗	✓ after LBUS upgrade	✓	✗
K2.0043975	TRINITY 2 Joystick Cable, 1,25m/49in	Flexible joystick cable to connect the Master Grip TRINITY to the TRINITY 2 head when the rig is fully extended or when using a Super Post. Lemo 0B 4-pin to Lemo 0B 4-pin, 24V, 125cm/49in	✗	✗	✓ after LBUS upgrade	✓	✗
K2.0043884	TRINITY 2 analog Joystick Cable	Analog joystick cable to connect the analog TRINITY Gen. 1 Joystick with TRINITY 2. Lemo 1B 8-pin to Lemo 0B 7-pin, no video, 12V	✗	✗	✓	✓	✗
K2.0014805	TRINITY Gen. 1 Joystick Main Cable	TRINITY Gen. 1 Joystick Main Cable including the BNC-SMB Cable. Lemo 1B 8-pin to Lemo 0B 7-pin, 12V	✗	✗	✓	✗	✗
K2.0014801	Joystick Pwr. Cable for ARRI Starlite	Power cable to connect the ARRI Starlight monitor to the TRINITY Gen.1 Joystick Monitor Mount. Lemo 0B 5-pin 90° elbow to Lemo 0B 5-pin, 12V	✗	✗	✓	✗	✗
K2.0014803	Joystick Pwr. Cable for Starlite	Power cable to connect the Transvideo Starlight, or Small HD 503 monitor to the TRINITY Gen. 1 Joystick Monitor Mount. Lemo 0B 5-pin 90° elbow to Lemo 0B 2-pin, 12V	✗	✗	✓	✗	✗

Stabilizer System - Cable Guide 3



Configuration Overview | 8.6.2 / 2024.08

Item Number	Cable Name	Supported Cameras	Artemis 1	Artemis 2	TRINITY 1	TRINITY 2	360 EVO
K2.0037459	Volt Pwr Cable 0B 3-pin to 0S 4-pin 0.3 m/0.9ft	Power cable to power the Volt Control Box from the artemis Cine Gen.1 top stage. Lemo 0B 3-pin - Lemo 0S 4-pin, Length: 0.3m/0.9ft, 12V	✓	✗	✗	✗	✗
K2.0037457	Volt Pwr Cable 0B 3-pin to RS 3-pin 0.3 m/0.9ft	Power cable to power the Volt™ Control Box from the ARTEMIS Gen. 2 top stage. Lemo 0B 3-pin - Fischer 3-pin, 12v, Length: 0.3m/0.9ft	✗	✓	✗	✗	✗
K2.0037460	Volt Pwr Cable 0B 3-pin to 0B 2-pin, 0.4 m/1.3ft	Power cable to power the Volt™ Control Box from the ARTEMIS top stage. Lemo 0B 3-pin - Lemo 0B 2-pin, 12V, Length: 0.4m/1.3ft	✗	✓	✗	✗	✗
K2.0043883	RCP-3, FS Can Bus Cable, 25cm/10in	Power and data cable to connect the RCP-3 remote control to the TRINITY2 system. Fischer 4-pin to Fischer 4-pin, 12v, 25cm/10in	✗	✗	✗	✓	✗
K2.0042631	TRH-2 Ring Main Cable, Standard, 0,65m/25.5in	Flexible standard main cable to connect the outer ring of the TRINITY 2 to the inner ring. High-capacity 12V/24V, Data, 1 x 12G Video, LBUS, Can Bus, tally Length: 0,65m/25,5in	✗	✗	✗	✓	✓
K2.0042681	TRH-2 Ring Main Cable, Long, 0,75m/29.5in	Extra long flexible main cable to connect the outer ring of the TRINITY 2 to the inner ring. High-capacity 12v/24V, Data, 1 x 12G video, LBUS, Can Bus, tally Length: 0,65m/26in	✗	✗	✗	✓	✓
K2.0040332	Post Main Cable, 3B, 16pin	Main cable for ARTEMIS 2 and TRINITY 2. High-capacity 12V/24V, Data, 2 x 12G video, LBUS, Can Bus, tally Lemo 3B 16-pin to Lemo 3B 16-pin	✗	✓	✗	✓	✗
K2.0041161	Super Post Main Cable, 3B, 16-pin	Super Post main cable for ARTEMIS 2 and TRINITY 2. Lemo 3B 16-pin to Lemo 3B 16-pin High-capacity 12V/24V, 2 x 12G video, LBUS, Can Bus, tally	✗	✓	✗	✓	✗
K2.0010552	Post Main Cable, 3B, 10-pin	Main cable for artemis Gen.1 and TRINITY Gen.1. Lemo 3B 10-pin to Lemo 3B 10-pin High-capacity 12V / 24V, 2x 4G Video, Tally	✓	✗	✓	✗	✗
K2.0041993	Super Post Main Cable, 3B, 10-pin	Super Post main cable for artemis Gen.1 and TRINITY Gen.1. High-capacity 12V/24V, 2x 4G video, tally Lemo 3B 10-pin to Lemo 3B 1-0pin	✓	✗	✓	✗	✗
K2.0043669	Post Main Cable, TRINITY Live	Special main cable for the TRINITY Live Gen. 1 High-capacity 12V, Data, 2 x 4G video, tally Lemo 3B 10-pin to Lemo 3B 10-pin	✗	✗	✓	✗	✗
K2.0050244	12V/24V TRINIY 1 Live Power Cable		✗	✗	✓	✗	✗
K2.0050770	Communication Cable, TRINITY 2 Pan Axis		✗	✗	✗	✓	✗
						PAN Axis only	

Stabilizer System - Cable Guide 4



Configuration Overview | 8.6.3 / 2024.08

Item Number	Cable Name	Supported Cameras	Artemis 1	Artemis 2	TRINITY 1	TRINITY 2	360 EVO
K0.0021437	SRH High Capacity Battery Power Cable Set, 12V/24V, 20m/66ft	12V/24V high-capacity battery power cable set to connect a 12V/24V block battery to the 360 EVO, SRH-3 and SRH-360. includes: K2.0019306 1x SRH High-Capacity Battery Power Cable, 12V/24V, 0.5m/1.64ft, K2.0021429 1x SRH High-Capacity Battery Power Cable 24	X	X	X	✓ PAN Axis only	✓
K0.0021438	SRH High-Capacity Battery Power Cable Set 12V/24V, 10m/33ft.	„12V/24V high-capacity battery power cable set to connect a 12V/24V block battery to the 360 EVO, SRH-3 and SRH-360. includes: K2.0019306 1x SRH High-Capacity Battery Power Cable, 12V/24V, 0.5m/1.64ft, K2.0021427 1x SRH High-Capacity Battery Power Cable 24	X	X	X	✓ PAN Axis only	✓
K2.0019306	SRH High-Capacity Battery Power Cable, 12V/24V, 0.5m/1.64ft	Power cable to power the Stabilized Remote Head 360 EVO, SRH-3 and SRH-360 with 12 V and 24 V power from a high-capacity battery providing 12 V and 24 V power. 12 V 4-pin XLR and 24 V 3-pin XLR, Length: 0.5 m/1.64ft	X	X	X	✓ PAN Axis only	✓
K2.0021430	SRH High Capacity Battery Power Cable 12V, 4-pin XLR, 20m/66ft	12V high-capacity extension cable to connect a block battery with the SRH High-Capacity Battery Power Cable, 12V/24V, 0.5m/1.64ft (K2.0019306), 12V high-capacity, 4-pin XLR, Length: 20m/66ft	X	X	X	✓ PAN Axis only	✓
K2.0021429	SRH High-Capacity Battery Power Cable 24V, 3-pin XLR, 20m/66ft	24V high-capacity extension cable to connect a block battery with the SRH High-Capacity Battery Power Cable, 12V/24V, 0.5m/1.64ft (K2.0019306), 24V high-capacity, 3-pin XLR, Length: 20m/66ft	X	X	X	✓ PAN Axis only	✓
K2.0021428	SRH High-Capacity Battery Power Cable 12V, 4-pin XLR, 10m/33ft	12V high-capacity extension cable to connect a block battery with the SRH High-Capacity Battery Power Cable, 12V/24V, 0.5m/1.64ft (K2.0019306), 12V high-capacity, 4-pin XLR, Length: 10m/33ft	X	X	X	✓ PAN Axis only	✓
K2.0021427	SRH High-Capacity Battery Power Cable 24V, 3-pin XLR, 10m/33ft	24V high-capacity extension cable to connect a block battery with the SRH High Capacity Battery Power Cable, 12V/24V, 0.5m/1.64ft (K2.0019306). 24V high-capacity, 3-pin XLR, Length: 10m/33ft	X	X	X	✓ PAN Axis only	✓
K2.0037788	SRH FS CAN Bus Cable, 0,3m/0,98ft	Extension cable to connect the SRH remote control panel and the SRH remote head. Extension cable to connect the ERM-2400 (2.4GHz) K2.0033757 and ERM-900 (900 MHz) K2.0033758 to the SRH remote control panel and remote head. Extension cable to connect the ERM-LCS to the WCU-4, SXU-1, EXT and LBUS compatible products. Length: 0,3m/0,98ft	X	X	X	✓	✓
K2.0033762	SRH FS CAN Bus Cable, 1m/3.2ft	Extension cable to connect the SRH remote control panel and the SRH remote head. Extension cable to connect the ERM-2400 (2.4GHz) K2.0033757 and ERM-900 (900 MHz) K2.0033758 to the SRH remote control panel and remote head. Extension cable to connect the ERM-LCS to the WCU-4, SXU-1, EXT and LBUS compatible products. Length: 1m/3.2ft	X	X	X	✓	✓
K2.0037701	SRH FS CAN Bus Cable, 5m/16.4ft	Extension cable to connect the SRH remote control panel and the SRH remote head. Extension cable to connect the ERM-2400 (2.4GHz) K2.0033757 and ERM-900 (900 MHz) K2.0033758 to the SRH remote control panel and remote head. Extension cable to connect the ERM-LCS to the WCU-4, SXU-1, EXT and LBUS compatible products. Length: 5m/16.4ft	X	X	X	✓	✓
K2.0019302	SRH FS CAN Bus Cable, 10m/32.8ft	Extension cable to connect the SRH remote control panel and the SRH remote head. Extension cable to connect the ERM-2400 (2.4GHz) K2.0033757 and ERM-900 (900 MHz) K2.0033758 to the SRH remote control panel and remote head. Extension cable to connect the ERM-LCS to the WCU-4, SXU-1, EXT and LBUS compatible products. Length: 10m/32.8ft	X	X	X	✓	✓
K2.0019301	SRH FS CAN Bus Cable, 25m/82ft	Extension cable to connect the SRH remote control panel and the SRH remote head. Extension cable to connect the ERM-2400 (2.4GHz) K2.0033757 and ERM-900 (900 MHz) K2.0033758 to the SRH remote control panel and remote head. Extension cable to connect the ERM-LCS to the WCU-4, SXU-1, EXT and LBUS compatible products. Length: 25m/82ft	X	X	X	✓	✓
K2.0019300	SRH FS CAN Bus Coupler, 0.2m/0.65ft	Coupler to extend SRH FS CAN Bus, Length: 0.2m/0.65ft	X	X	X	✓	✓

Stabilizer System - Cable Guide 5



Configuration Overview | 8.6.4 / 2024.08

Item Number	Cable Name	Supported Cameras	Artemis 1	Artemis 2	TRINITY 1	TRINITY 2	360 EVO
K2.0019303	SRH Power Supply Power and Data Cable, 12V/24V, 20m/65.6ft	Power and data cable to power the Stabilized Remote Head 360 EVO, SRH-3 and SRH360 from the 600 W SRH Power Supply K0.0019478 with 12 V and 24 V. 12V/24V high-capacity camera power, plus FS CAN bus. Length: 20m/65.6ft	X	X	X	✓ PAN Axis only	✓
K2.0033761	ERM Power Cable, ERM-2400 & ERM-900	Spare ERM Power Cable for ERM-2400 & ERM-900 Length: 30cm / 11.8in"	X	X	X	✓	✓
K2.0036900	ERM LCS to FS CAN Bus Adapter Cable, 0.2m/0.65ft	Adapter cable to connect the ERM LCS to the WCU-4, SXU-1 UMC-4 and ALEXA Plus camera via the LCS socket.	X	X	X	✓	✓
K2.0036903	ERM LBUS to FS CAN Bus Adapter Cable, 0.2m/0.65ft	Adapter cable to connect the ERM LCS to Master Grips, OCU-1, DRW-1 and DEH-1 via the LBUS socket	X	X	X	✓	✓
K2.0036901	ERM EXT. to FS CAN Bus Adapter Cable, 0.2m/0.65ft	Adapter cable to connect the ERM LCS to ALEXA Mini, ALEXA Mini LF and Amira via the EXT. socket.	X	X	X	✓	✓
K2.0036902	ERM D-Tap Pwr Cable, 0B Lemo 2-pin to D-Tap, 1m/3.2ft	Power cable D-Tap to 2-pin Lemo 0B. Length: 1m/3.2ft	X	X	X	✓	✓
K2.0041984	12G HD SDI BNC Cable, 0,63m/25in	12G HD SDI BNC Cable, Length: 0,63m/25in	✓	✓	✓	✓	✓
K2.0044234	12G HD SDI BNC Cable, 0,84m/33in	12G HD SDI BNC Cable, Length: 0,84m/33in	✓	✓	✓	✓	✓
K2.0051086	12G HD SDI BNC Cable, 1,3m/51,2in	12G HD SDI BNC Cable, Length: 0,84m/33in	✓	✓	✓	✓	✓
K2.0014804	TRINITY BNC Cable for Joystick Main Cable	Spare BNC-SMB cable for the TRINITY Joystick Main Cable	X	X	✓	X	X
K2.0010482	Tally Sensor Cable, Gen.1 & 2	Tally Sensor Cable can be used with the first and second generation of the Tally system. Lemo 0S 4pin Length: 0,55m / 1.80 ft	✓	✓	✓	✓	X
K2.0047301	Tally Gen. 2 Cable CCP Live	Power / Tally cable that connects the Tally host module to CCP Live. Lemo 0S 4pin to 0S 4pin Length: 0,55m / 1.80 ft	✓	✓	✓	✓	X

Configuration Overview | 9.1.0 / 2025.03

ARRISCAN XT incl. Wet Gate



ARRISCAN XT Archive Wet // 230V, D0.0019818
includes:
D0.0019817 1x ARRISCAN XT Archive // 230V
D0.14900.0 1x 35mm and 16mm Wet Gate System

ARRISCAN XT Archive Wet // 110V, D0.0019816
includes:
D0.0019815 1x ARRISCAN XT Archive // 110V
D0.14900.0 1x 35mm and 16mm Wet Gate System

ARRISCAN XT



ARRISCAN XT Archive // 230V, D0.0019817
includes:
D1.0016977 1x ARRISCAN XT
D2.0019752 1x 35mm Archive Pin Gate Package (28.0 mm x 21.5 mm)
D2.14935.0 1x 16mm Archive Pin Gate Package (14.2 mm x 9.1 mm)
D2.14355.1 1x Built-In Stabilization
D2.0020671 1x AXT UPS 230V

ARRISCAN XT Archive // 110V, D0.0019815
includes:
D1.0016977 1x ARRISCAN XT
D2.0019752 1x 35mm Archive Pin Gate Package (28.0 mm x 21.5 mm)
D2.14935.0 1x 16mm Archive Pin Gate Package (14.2 mm x 9.1 mm)
D2.14355.1 1x Built-In Stabilization
D2.0020774 1x AXT UPS 110V

Wet Gate



35mm and 16mm Wet Gate System, D0.14900.0
Complete 35mm and 16mm Wet Gate System for scratch concealment while scanning.
Note: Requires compressed air supply, filtered and oilfree; Kodika SES liquid must be purchased separately at supplier.
includes:
D2.14800.0 1x 35mm Wet Gate (34.5 mm x 21.9 mm)
D2.14700.0 1x 16mm Wet Gate (13.2 mm x 10.0 mm)
D2.14900.0 1x Wet Gate Tower
D4.13023.0 1x Wet Gate Retrofit Set

ARRISCAN XT Software Options



Optical Sound Decoding System, D0.0019236
Stand alone certified hardware package and unique Image to Sound Tools audio decoding software extracts the optical soundtrack from ARRISCAN image files no matter whether it is print film or sound negative, variable density or variable area.
includes:
D2.0019231 1x Optical Sound Decoding Software License
D2.0019232 1x Optical Sound Decoding Workstation



IR-Cleaner, D0.0019788
Software License to use the ARRISCAN XT raw infrared channel for third party products, incl. special DIAMANT-Film IR-Cleaner dust busting GUI application for running on ARRISCAN XT
includes:
D2.0019781 1x IR-Cleaner Software License
10.0019777 1x Infrared System ARRISCAN XT

IR-Cleaner DustBuster+, D0.0019786
Software License to use the ARRISCAN XT raw infrared channel for third party products, including DIAMANT-Film DustBuster+ for running on ARRISCAN XT.
includes:
D2.0019780 1x DustBuster+ Software License
10.0019777 1x Infrared System ARRISCAN XT



Black & White Scan Mode, 10.0044235
Software license that enables the single color scan mode based only on red, green or blue exposure and supports the output of mono black and white DPX and TIFF files.



ProRes Output AXT, 10.0048485
The supported ProRes flavours are 422 HQ, 4444 and 4444 XQ. It is possible to write 10-, 12- and 16-bit DPX files in parallel to the ProRes MXF.

Networking & File Transfer



Host Computer SAN Kit, D2.0019890
Dual Port 16 Gbit/s Gen 6 Fiber Channel PCIe 3.0 Host Bus Adapter (HBA) including SFPs provides an advanced storage connectivity solution for the ARRISCAN XT host computer to StorNext or CXFS SAN storage.



Host Computer Fiber Ethernet Kit, D2.0020102
Dual Port Fiber 10 Gbit/s Ethernet PCIe 2.0 x8 network adapter with multimode SFP+ Transceivers to connect ARRISCAN XT host computer to NAS system or file server.

Service & Maintenance

ARRISCAN XT - Basic 10.0019907
included Key Benefits:
• 15% discount on spare parts
• Instant gate exchange in case of gate defect
• Free of charge shipping costs within the EU
• 16 hours free of charge service on-site
• 1x free of charge on-site visit (incl. Travel expenses and travel time)
• Free of charge software updates
• Unlimited phone, e-mail and remote support
• Reaction time within 24 hours

ARRISCAN XT - Prime 10.0020230
included Key Benefits:
• All spare parts included
• Instant gate exchange in case of gate defect
• Free of charge shipping costs within the EU
• All necessary service visits covered
• Free of charge software updates
• Unlimited phone, e-mail and remote support
• Reaction time within 24 hours

Transport Options



Sprocketless Set Full (up to Serial No. 125), D2.14380.0
Sprocketless transport system incl. ultrasonic loop monitoring and special loopbuilders for traditional ARRISCANs not yet fitted with exchangeable sprockets



Sprocketless Set Small (from Serial No. 125), D2.14370.0
Sprocketless transport system incl. ultrasonic loop monitoring and special loopbuilders for ARRISCANs already fitted with exchangeable sprockets

16mm Supporting Film Plate, D2.0000482
Plate supporting shrunken and warped film on the take up sides inches film core

Wet Gate Accessories



Additional Wet Gate Drying System, D2.14940.0



Wet Gate Preparation Kit Extended (up to Serial No. 110), D2.14920.0



35mm Wet Gate (34.5 mm x 21.9 mm)
D2.14800.0



16mm Wet Gate (13.2 mm x 10.0 mm)
D2.14700.0



16mm Wet Gate System, D0.14700.0
Complete 16mm Wet Gate System for scratch concealment while scanning.
Note: Requires compressed air supply, filtered and oilfree; Kodika SES liquid must be purchased separately at supplier.
includes:
D2.14700.0 1x 16mm Wet Gate (13.2 mm x 10.0 mm)
D2.14900.0 1x Wet Gate Tower
D4.13023.0 1x Wet Gate Retrofit Set



35mm Wet Gate System, D0.14800.0
Complete 35mm Wet Gate System for scratch concealment while scanning.
Note: Requires compressed air supply, filtered and oilfree; Kodika SES liquid must be purchased separately at supplier.
includes:
D2.14800.0 1x 35mm Wet Gate (34.5 mm x 21.9 mm)
D2.14900.0 1x Wet Gate Tower
D4.13023.0 1x Wet Gate Retrofit Set

Upgrade ARRISCAN to ARRISCAN XT



Configuration Overview | 9.2.0 / 2025.03

ARRISCAN → ARRISCAN XT



ARRISCAN + XT - Upgrade Package = ARRISCAN XT

ARRISCAN XT - Upgrade Package // 230V D2.0016979
ARRISCAN XT - Upgrade Package // 110V D2.0019855

ARRISCAN XT on-site upgrade available for all Arriscan „Classic“. Includes camera head replacement to ALEXA XT sensor, exchange of image processing unit, power supply unit, illumination rack, touch panel, new ARRISCAN XT branding, GUI software update, new UPS and new host computer integrated in ARRISCAN housing. Fully compatible to all existing film gates, wet gate system and sprocketless transport.

Note:
 > Ownership of replaced parts will pass to ARRI
 > Renewed 12 month manufacturer warranty for exchanged new components

ARRISCAN XT Software Options

Optical Sound Decoding System, D0.0019236

Stand alone certified hardware package and unique Image to Sound Tools audio decoding software extracts the optical soundtrack from ARRISCAN image files no matter whether it is print film or sound negative, variable density or variable area. includes:
 D2.0019231 1x Optical Sound Decoding Software License
 D2.0019232 1x Optical Sound Decoding Workstation



IR-Cleaner, D0.0019788

Software License to use the ARRISCAN XT raw infrared channel for third party products, incl. special DIAMANT-Film IR-Cleaner dust busting GUI application for running on ARRISCAN XT includes:
 D2.0019781 1x IR-Cleaner Software License
 10.0019777 1x Infrared System ARRISCAN XT

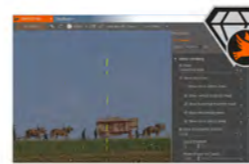

IR-Cleaner DustBuster+, D0.0019786

Software License to use the ARRISCAN XT raw infrared channel for third party products, including DIAMANT-Film DustBuster+ for running on ARRISCAN XT. includes:
 D2.0019780 1x DustBuster+ Software License
 10.0019777 1x Infrared System ARRISCAN XT

Black & White Scan Mode, 10.0044235

Software license that enables the single color scan mode based only on red, green or blue exposure and supports the output of mono black and white DPX and TIFF files.



ProRes Output AXT, 10.0048485

The supported ProRes flavours are 422 HQ, 4444 and 4444 XQ. It is possible to write 10-, 12- and 16-bit DPX files in parallel to the ProRes MXF.

Built-In Stabilization, D2.14355.1

Software license for on-the-fly image stabilization referenced to perf position, when pin-registered scanning is not possible. Registration pin must be retracted.

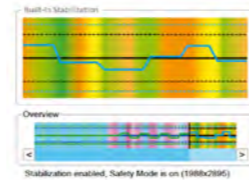

Networking & File Transfer

Host Computer SAN Kit, D2.0019890

Dual Port 16 Gbit/s Gen 6 Fiber Channel PCIe 3.0 Host Bus Adapter (HBA) including SFPs provides an advanced storage connectivity solution for the ARRISCAN XT host computer to StorNext or CXFS SAN storage.



Host Computer Fiber Ethernet Kit, D2.0020102

Dual Port Fiber 10 Gbit/s Ethernet PCIe 2.0 x8 network adapter with multimode SFP+ Transceivers to connect ARRISCAN XT host computer to NAS system or file server.



Transport Options

Sprocketless Set Full (up to Serial No. 125), D2.14380.0

Sprocketless transport system incl. ultrasonic loop monitoring and special loopbuilders for traditional ARRISCANs not yet fitted with exchangeable sprockets



Sprocketless Set Small (from Serial No. 125), D2.14370.0

Sprocketless transport system incl. ultrasonic loop monitoring and special loopbuilders for ARRISCANs already fitted with exchangeable sprockets



16mm Supporting Film Plate, D2.0000482

Plate supporting shrunken and warped film on the take up sides inches film core



Wet Gate accessories

Additional Wet Gate Drying System, D2.14940.0

Wet Gate Preparation Kit Extended (up to Serial No. 110), D2.14920.0



Film Gate upgrades

35mm Archive Pin Gate Upgrade Package, D0.0020755

Upgrade from regular pin registered 35mm Gate (D2.0019653) to 35mm Archive Pin Gate with oversized aperture (28.0 mm x 21.5 mm) includes:
 D2.0019031 1x 35mm Archive Pin Gate Upgrade
 D2.14355.1 1x Built-In Stabilization

16mm Archive Pin Gate Upgrade Package, D0.14325.0

Upgrade from regular 16mm Gate (D2.14200.0) to 16mm Archive Pin Gate with oversized aperture (14.2 mm x 9.1 mm) includes:
 D2.14936.0 1x 16mm Archive Pin Gate Upgrade
 D2.14355.1 1x Built-In Stabilization

35mm Archive Pin Gate Upgrade, D2.0019031

Upgrade from regular pin registered 35mm Gate (D2.0019653) to 35mm Archive Pin Gate with oversized aperture (28.0 mm x 21.5 mm)

16mm Archive Pin Gate Upgrade, D2.14936.0

Upgrade from regular 16mm Gate (D2.14200.0) to 16mm Archive Pin Gate with oversized aperture (14.2 mm x 9.1 mm)

Service & Maintenance

ARRISCAN XT Upgrade - Prime 10.0021165

The Prime XT Upgrade contract is the perfect complement to ensure that you get the best possible service for your upgraded ARRISCAN XT. All spare parts and related service needs which are not included in the XT Upgrade Package are covered.

Key Benefits:

- Includes all spare parts which are not part of the XT Upgrade Package
- Instant gate exchange in case of gate defect
- Free of charge shipping costs within the EU
- All necessary service visits covered
- Free of charge software updates
- Unlimited phone, e-mail and remote support
- Reaction time within 24 hours

Wet Gate

Wet Gate also compatible without XT upgrade



35mm and 16mm Wet Gate System, D0.14900.0
 Complete 35mm and 16mm Wet Gate System for scratch concealment while scanning.
 Note: Requires compressed air supply, filtered and oilfree; Kodika SES liquid must be purchased separately at supplier.
 includes:
 D2.14800.0 1x 35mm Wet Gate (34.5 mm x 21.9 mm)
 D2.14700.0 1x 16mm Wet Gate (13.2 mm x 10.0 mm)
 D2.14900.0 1x Wet Gate Tower
 D4.13023.0 1x Wet Gate Retrofit Set



16mm Wet Gate System, D0.14700.0
 Complete 16mm Wet Gate System for scratch concealment while scanning.
 Note: Requires compressed air supply, filtered and oilfree; Kodika SES liquid must be purchased separately at supplier.
 includes:
 D2.14700.0 1x 16mm Wet Gate (13.2 mm x 10.0 mm)
 D2.14900.0 1x Wet Gate Tower
 D4.13023.0 1x Wet Gate Retrofit Set



35mm Wet Gate System, D0.14800.0
 Complete 35mm Wet Gate System for scratch concealment while scanning.
 Note: Requires compressed air supply, filtered and oilfree; Kodika SES liquid must be purchased separately at supplier.
 includes:
 D2.14800.0 1x 35mm Wet Gate (34.5 mm x 21.9 mm)
 D2.14900.0 1x Wet Gate Tower
 D4.13023.0 1x Wet Gate Retrofit Set



35mm Wet Gate (34.5 mm x 21.9 mm)
 D2.14800.0



16mm Wet Gate (13.2 mm x 10.0 mm)
 D2.14700.0