







# Camera Product Comparison - ARRI Camera Models - part I



Configuration Overview | 1.0.0 / 2025.07







Model / Weight	Sensor Type	Sensor Size	Dynamic Range	Frame Rate	Codecs
 <b>ALEXA 35 Xtreme Premium Model</b> 3 kg / 6,6 lbs (1)	Super 35 format ARRI ALEV 4 CMOS sensor with Bayer pattern color filter array	4608 x 3164 27.99 x 19.22 mm 1.102x 0.757" Ø 33.96 mm / 1.337"	17 stops * EI 160 to EI 6400 EI 2560 ES to EI 6400 ES 11 stops ** EI 800 to EI 6400	0,75 - 660 fps  * ARRIRAW, ARRICORE, ProRes ** ARRICORE / Sensor Overdrive	MXF/ARRIRAW MXF/Apple ProRes 4444 MXF/Apple ProRes 4444 XQ MXF/Apple ProRes 422 HQ MXF/ARRICORE
 <b>ALEXA 35 Xtreme Base Model</b> 3 kg / 6,6 lbs (1)	Super 35 format ARRI ALEV 4 CMOS sensor with Bayer pattern color filter array	4608 x 3164 27.99 x 19.22 mm 1.102x 0.757" Ø 33.96 mm / 1.337"	17 stops EI 160 to EI 6400 EI 2560 ES to EI 6400 ES	0,75 - 60 fps	MXF/ARRICORE MXF/Apple ProRes 4444 MXF/Apple ProRes 4444 XQ MXF/Apple ProRes 422 HQ
 <b>ALEXA 35 Live</b> 2,9 kg / 6,4 lbs (1)	Super 35 format ARRI ALEV 4 CMOS sensor with Bayer pattern color filter array	4608 x 3164 27.99 x 19.22 mm 1.102x 0.757" Ø 33.96 mm / 1.337"	17 stops EI 160 to EI 6400 EI 2560 ES to EI 6400 ES	0,75 - 60 fps	MXF/Apple ProRes 4444 MXF/Apple ProRes 4444 XQ MXF/Apple ProRes 422 HQ
 <b>ALEXA Mini LF</b> 2,6 kg / 5,7 lbs (2)	Large Format ARRI ALEV 3 (A2X) CMOS sensor with Bayer pattern color filter array	4448 x 3096 36.70 x 25.54 mm 1.444 x 1.005" Ø 44.71 mm / 1.760"	14+ stops EI 160 to EI 3200	0,75 - 90 fps	MXF/ARRIRAW MFX/Apple ProRes 4444 MFX/Apple ProRes 4444 XQ MFX/Apple ProRes 422 HQ
 <b>ALEXA LF</b> 7,8 kg / 17,2 lbs (3)	Large Format ARRI ALEV 3 (A2X) CMOS sensor with Bayer pattern color filter array	4448 x 3096 36.70 x 25.54 mm 1.444 x 1.005" Ø 44.71 mm / 1.760"	14+ stops EI 160 to EI 3200	0,75 - 150 fps	ARRIRAW Apple ProRes 422 HQ Apple ProRes 4444 XQ Apple ProRes 422 Apple ProRes 4444
 <b>AMIRA</b> 4,1 kg / 9,2 lbs (1)	Super 35 format ARRI ALEV 3 CMOS sensor with Bayer pattern color filter array	3200 x 1800 26.40 x 14.85 mm 1.039 x 0.585" Ø 30.29 mm / 1.193"	14+ stops EI 160 to EI 3200	0,75 - 200 fps	MFX/ARRIRAW Apple ProRes 422 Apple ProRes 4444 XQ Apple ProRes 422 LT Apple ProRes 4444 MPEG-2 HD Apple ProRes 422 HQ
 <b>AMIRA Live</b> 5,2 kg / 11,5 lbs (4)	Super 35 format ARRI ALEV 3 CMOS sensor with Bayer pattern color filter array	3200 x 1800 26.40 x 14.85 mm 1.039 x 0.585" Ø 30.29 mm / 1.193"	14+ stops EI 160 to EI 3200	0,75 - 200 fps	MFX/ARRIRAW Apple ProRes 422 Apple ProRes 4444 XQ Apple ProRes 422 LT Apple ProRes 4444 MPEG-2 HD Apple ProRes 422 HQ

(1) camera body with PL lens mount (2) camera body with LPL Mount (3) camera body & recording module & lens mount (4) camera body with AMIRA Live Fiber Adapter and PL lens mount

# Camera Product Comparison - ARRI Camera Models - part II



Configuration Overview | 1.0.1 / 2025.07

Model / Weight	Viewfinder/Monitor	Recording Media	Power Input	Lens Mounts	
 <b>ALEXA 35 Xtreme Premium Model</b> 2,9 kg / 6,4 lbs (1)	Multi Viewfinder MVF-2 with 4" flip-out monitor  Camera Control Monitor CCM-1 7" high-bright touchscreen monitor	CODEX Compact Drive 1TB CODEX Compact Drive 2TB CODEX Compact Drive Express 1TB (5)	1x PWR (LEMO 8-pin) (20.5 - 33.6 V DC) 1x BAT (camera rear interface) (20.5 - 33.6 V DC)	ARRI LPL Mount (LBUS) ARRI PL-to-LPL Adapter ARRI PL Mount (LBUS)	ARRI PL (Hirose) ARRI EF Mount (LBUS) Leitz M Mount for ARRI
 <b>ALEXA 35 Xtreme Base Model</b> 2,9 kg / 6,4 lbs (1)	Multi Viewfinder MVF-2 with 4" flip-out monitor  Camera Control Monitor CCM-1 7" high-bright touchscreen monitor	CODEX Compact Drive 1TB CODEX Compact Drive 2TB CODEX Compact Drive Express 1TB (5)	1x PWR (LEMO 8-pin) (20.5 - 33.6 V DC) 1x BAT (camera rear interface) (20.5 - 33.6 V DC)	ARRI LPL Mount (LBUS) ARRI PL-to-LPL Adapter ARRI PL Mount (LBUS)	ARRI PL (Hirose) ARRI EF Mount (LBUS) Leitz M Mount for ARRI
 <b>ALEXA 35 Live</b> 2,9 kg / 6,4 lbs (1)	Multi Viewfinder MVF-2 with 4" flip-out monitor  Camera Control Monitor CCM-1 7" high-bright touchscreen monitor	CODEX Compact Drive 1TB CODEX Compact Drive 2TB CODEX Compact Drive Express 1TB (5)	1x PWR (LEMO 8-pin) (20.5 - 33.6 V DC) 1x BAT (camera rear interface) (20.5 - 33.6 V DC)	ARRI LPL Mount (LBUS) ARRI PL-to-LPL Adapter ARRI PL Mount (LBUS)	ARRI PL (Hirose) ARRI EF Mount (LBUS) Leitz M Mount for ARRI
 <b>ALEXA Mini LF</b> 2,6 kg / 5,7 lbs (2)	Multi Viewfinder MVF-2 with 4" flip-out monitor  Camera Control Monitor CCM-1 7" high-bright touchscreen monitor	CODEX Compact Drive 1TB  CODEX Compact Drive 2TB	1x LEMO 8pin (11-34 V DC)	ARRI PL Mount (LBUS) ARRI PL-to-LPL Adapter	ARRI EF Mount (LBUS) Leitz M Mount for ARRI
 <b>ALEXA LF</b> 7,8 kg / 17,2 lbs (3)	Electronic Viewfinder EVF-1 with 235 eyepiece  Electronic Viewfinder EVF-2 with ARRICAM eyepiece	SXR Capture Drives  SxS PRO+ Cards	1x Fischer 2pin BAT connector (18.5-34 V DC) 1x On-board battery interface (19.5-34 V DC)	LPL lens mount ARRI PL-to-LPL Adapter	PL lens mount
 <b>AMIRA</b> 4,1 kg / 9,2 lbs (1)	Multi Viewfinder MVF-1 with 3,2" flip-out monitor  Camera Control Panel (CCP-1) with option to daisy-chain MVF-1	CFast 2.0 Cards	1x Fischer 2pin BAT connector (10.5-34 V DC) 1x On-board battery interface (10.5-34 V DC)	ARRI PL (Hirose) EF lens mount B4 (Hirose)	ARRI PL Mount (LBUS) Leitz M Mount for ARRI ARRI PL-to-LPL Adapter
 <b>AMIRA Live</b> 5,2 kg / 11,5 lbs (4)	Multi Viewfinder MVF-1 with 3,2" flip-out monitor  Camera Control Panel (CCP-1) with option to daisy-chain MVF-1	CFast 2.0 Cards	1x LEMO 8pin (10.5-34 V DC) 12.0 V to 17.0 V DC via Lemo 2-pin on FCA	ARRI PL (Hirose) EF lens mount B4 (Hirose)	ARRI PL Mount (LBUS) Leitz M Mount for ARRI ARRI PL-to-LPL Adapter

(1) camera body with PL lens mount    (2) camera body with LPL Mount    (3) camera body & recording module & lens mount    (4) camera body with AMIRA Live Fiber Adapter and PL lens mount    (5) ProRes only

# ALEXA 35 Xtreme - Feature Licenses



Configuration Overview | 1.1.0 / 2025.07

	pre-installed licenses when ordering an ALEXA 35 Xtreme		Licences for individual purchase					
	Premium License	Basic License	Premium	High Speed	ARRIRAW	Open Gate / Anamorphic	Pre-record	Look
Permanent	pre-installed	pre-installed	10.0053851	10.0052056	10.0052061	10.0052065	10.0052069	10.0052073
Temporary - 1 Year	-	-	10.0053853	10.0052058	10.0052062	10.0052066	10.0052070	10.0052074
Temporary - 30 days	-	-	10.0053854	10.0052059	10.0052063	10.0052067	10.0052071	10.0052075
Temporary - 7 days	-	-	10.0053855	10.0052060	10.0052064	10.0052068	10.0052072	10.0052076
0.75 - 60 fps	✓	✓						
ProRes Recording	✓	✓						
Enhanced Sensitivity	✓	✓						
ARRI Color Management (in-camera SDR & HDR DRTs)	✓	✓						
Basic 16:9 & 2:1 Spherical Recording Formats	✓	✓						
ARRI Look File (CDL & 3D LUTs)	✓	✓						
ARRICORE Recording	✓	✓						
Max fps for every available codec/recording format	✓		✓	✓				
ARRIRAW	✓		✓		✓			
Open Gate Recording Formats	✓		✓			✓		
Anamorphic Recording Formats	✓		✓			✓		
Anamorphic De-squeeze in Monitor Path	✓		✓			✓		
Pre-recording	✓		✓				✓	
ARRI Textures	✓		✓					✓
Look Library	✓		✓					✓
Custom Color Management	✓		✓					✓

# ALEXA 35 Xtreme - Base Camera Set Options



Configuration Overview | 1.1.1 / 2025.07

## Basic Sets



**ALEXA 35 Xtreme Base Entry Set (LPL, CCM), K0.0055015**  
includes:  
K1.0053455 1x ALEXA 35 Xtreme with Base License  
K2.0018983 1x ARRI LPL Mount (LBUS)  
K2.0016936 1x ARRI PL-to-LPL Adapter  
K2.0034180 1x Balance Utility Dovetail BUD-1  
K2.0023751 1x B-Mount Battery Adapter  
KK.0048851 1x Camera Control Monitor CCM-1 Set  
K2.0024745 1x Bridge Plate Adapter BPA-6  
K2.0017270 1x Center Camera Handle CCH-4  
K2.0034179 1x Universal Adapter Plate UAP-3



**ALEXA 35 Xtreme Base Operator Set (PL, MVF), K0.0055017**, includes:  
K1.0053455 1x ALEXA 35 Xtreme with Base License  
K2.0042652 1x ARRI PL Mount (Hirose)  
K2.0034180 1x Balance Utility Dovetail BUD-1  
K2.0023751 1x B-Mount Battery Adapter  
K2.0020916 1x Multi Viewfinder MVF-2  
K2.0042857 2x Cable VF Right Angle (0.5m/1.5ft)  
KK.0051696 1x Operator Set



**ALEXA 35 Xtreme Base Operator Set (LPL, MVF-2), K0.0055019**, includes:  
K1.0053455 1x ALEXA 35 Xtreme with Base License  
K2.0018983 1x ARRI LPL Mount (LBUS)  
K2.0016936 1x ARRI PL-to-LPL Adapter  
K2.0034180 1x Balance Utility Dovetail BUD-1  
K2.0023751 1x B-Mount Battery Adapter  
K2.0020916 1x Multi Viewfinder MVF-2  
K2.0042857 2x Cable VF Right Angle (0.5m/1.5ft)  
KK.0051696 1x Operator Set



**ALEXA 35 Xtreme Base Production Set (LPL, MVF, 19mm), K0.0055021**, includes:  
K1.0053455 1x ALEXA 35 Xtreme with Base License  
K2.0018983 1x ARRI LPL Mount (LBUS)  
K2.0016936 1x ARRI PL-to-LPL Adapter  
K2.0034180 1x Balance Utility Dovetail BUD-1  
K2.0023751 1x B-Mount Battery Adapter  
K2.0020916 1x Multi Viewfinder MVF-2  
K2.0042857 2x Cable VF Right Angle (0.5m/1.5ft)  
K2.75007.0 1x Camera Power Cable Straight 2m/6.6in KC-50  
K2.0024101 1x Power Distribution Module PDM-1  
KK.0041533 1x Production Support Set - Top  
KK.0041534 1x Production Support Set - Side  
KK.0041535 1x Production Support Set - Bottom (19mm)



**ALEXA 35 Xtreme Base Entry Set (LPL, CCM, CDX), K0.0055016**  
includes:  
K1.0053455 1x ALEXA 35 Xtreme with Base License  
K2.0018983 1x ARRI LPL Mount (LBUS)  
K2.0016936 1x ARRI PL-to-LPL Adapter  
K2.0034180 1x Balance Utility Dovetail BUD-1  
K2.0023751 1x B-Mount Battery Adapter  
KK.0048851 1x Camera Control Monitor CCM-1 Set  
K2.0024745 1x Bridge Plate Adapter BPA-6  
K2.0017270 1x Center Camera Handle CCH-4  
K2.0034179 1x Universal Adapter Plate UAP-3  
K2.0053843 3x CODEX Compact Drive Express 1TB  
K2.0024134 1x CODEX Compact Drive Reader (USB-C)



**ALEXA 35 Xtreme Base Operator Set (PL, MVF-2, CDX), K0.0055018**, includes:  
K1.0053455 1x ALEXA 35 Xtreme with Base License  
K2.0042652 1x ARRI PL Mount (Hirose)  
K2.0034180 1x Balance Utility Dovetail BUD-1  
K2.0023751 1x B-Mount Battery Adapter  
K2.0020916 1x Multi Viewfinder MVF-2  
K2.0042857 2x Cable VF Right Angle (0.5m/1.5ft)  
K2.0053843 3x CODEX Compact Drive Express 1TB  
K2.0024134 1x CODEX Compact Drive Reader (USB-C)  
KK.0051696 1x Operator Set



**ALEXA 35 Xtreme Base Operator Set (LPL, MVF-2, CDX), K0.0055020**, includes:  
K1.0053455 1x ALEXA 35 Xtreme with Base License  
K2.0018983 1x ARRI LPL Mount (LBUS)  
K2.0016936 1x ARRI PL-to-LPL Adapter  
K2.0034180 1x Balance Utility Dovetail BUD-1  
K2.0023751 1x B-Mount Battery Adapter  
K2.0020916 1x Multi Viewfinder MVF-2  
K2.0042857 2x Cable VF Right Angle (0.5m/1.5ft)  
K2.0053843 3x CODEX Compact Drive Express 1TB  
K2.0024134 1x CODEX Compact Drive Reader (USB-C)  
KK.0051696 1x Operator Set



**ALEXA 35 Xtreme Base Production Set (LPL, MVF, 15mm), K0.0055022**, includes:  
K1.0053455 1x ALEXA 35 Xtreme with Base License  
K2.0018983 1x ARRI LPL Mount (LBUS)  
K2.0016936 1x ARRI PL-to-LPL Adapter  
K2.0034180 1x Balance Utility Dovetail BUD-1  
K2.0023751 1x B-Mount Battery Adapter  
K2.0020916 1x Multi Viewfinder MVF-2  
K2.0042857 2x Cable VF Right Angle (0.5m/1.5ft)  
K2.75007.0 1x Camera Power Cable Straight 2m/6.6in KC-50  
K2.0024101 1x Power Distribution Module PDM-1  
KK.0041533 1x Production Support Set - Top  
KK.0041534 1x Production Support Set - Side  
KK.0041536 1x Production Support Set - Bottom (15mm)

# ALEXA 35 Xtreme - Premium Camera Set Options



Configuration Overview | 1.1.2 / 2025.10

## Premium Sets



### ALEXA 35 Xtreme Premium Production Set (19mm), K0.0055012, includes:

- KK.0055023 1x ALEXA 35 Xtreme with Premium License
- K2.0018983 1x ARRI LPL Mount (LBUS)
- K2.0016936 1x ARRI PL-to-LPL Adapter
- K2.0034180 1x Balance Utility Dovetail BUD-1
- K2.0023751 1x B-Mount Battery Adapter
- K2.0020916 1x Multi Viewfinder MVF-2
- K2.0042857 2x Cable VF Right Angle (0.5m/1.5ft)
- K2.75007.0 1x Camera Power Cable Straight 2m/6.6in KC-50
- K2.0024101 1x Power Distribution Module PDM-1
- KK.0041533 1x Production Support Set - Top
- KK.0041534 1x Production Support Set - Side
- KK.0041535 1x Production Support Set - Bottom (19mm)



### ALEXA 35 Xtreme Premium Operator Set, K0.0055014, includes:

- KK.0055023 1x ALEXA 35 Xtreme with Premium License
- K2.0018983 1x ARRI LPL Mount (LBUS)
- K2.0016936 1x ARRI PL-to-LPL Adapter
- K2.0034180 1x Balance Utility Dovetail BUD-1
- K2.0023751 1x B-Mount Battery Adapter
- K2.0020916 1x Multi Viewfinder MVF-2
- K2.0042857 2x Cable VF Right Angle (0.5m/1.5ft)
- KK.0051696 1x Operator Set



### ALEXA 35 Xtreme Premium Body & PL Mount Set, K0.0055025, includes:

- KK.0055023 1x ALEXA 35 Xtreme with Premium License
- K2.0034180 1x Balance Utility Dovetail BUD-1
- K2.0023751 1x B-Mount Battery Adapter
- K2.0042651 ARRI PL Lens Mount (LBUS)



### ALEXA 35 Xtreme Premium Production Set (15mm), K0.0055013, includes:

- KK.0055023 1x ALEXA 35 Xtreme with Premium License
- K2.0018983 1x ARRI LPL Mount (LBUS)
- K2.0016936 1x ARRI PL-to-LPL Adapter
- K2.0034180 1x Balance Utility Dovetail BUD-1
- K2.0023751 1x B-Mount Battery Adapter
- K2.0020916 1x Multi Viewfinder MVF-2
- K2.0042857 2x Cable VF Right Angle (0.5m/1.5ft)
- K2.75007.0 1x Camera Power Cable Straight 2m/6.6in KC-50
- K2.0024101 1x Power Distribution Module PDM-1
- KK.0041533 1x Production Support Set - Top
- KK.0041534 1x Production Support Set - Side
- KK.0041536 1x Production Support Set - Bottom (15mm)



### ALEXA 35 Xtreme Premium Body & LPL Mount Set, K0.0055024, includes:

- KK.0055023 1x ALEXA 35 Xtreme with Premium License
- K2.0034180 1x Balance Utility Dovetail BUD-1
- K2.0023751 1x B-Mount Battery Adapter
- K2.0018983 ARRI LPL Lens Mount (LBUS)
- K2.0016936 ARRI PL-to-LPL-Adapter

### ALEXA 35 Xtreme with Premium License, KK.0055023, includes:

- K1.0053455 1x ALEXA 35 Xtreme with Base License
- 10.0053856 1x Premium License ATO
- K5.0024646 Black Jog Wheel
- KK-Set available only as part of K0-Set



### Upgrade ALEXA 35 to ALEXA 35 Xtreme, K0.0055048, includes:

- K4.0053686 1x ALEXA 35 Xtreme Upgrade Kit
- 10.0000024 1x ALEXA 35 Upgrade Labor

## Storage Media



### CODEX Compact Drive Express 1TB, K2.0053843

CODEX Compact Dr Exp 1TB+Reader Bundle, [K0.0053933](#)



### CODEX Compact Drive 2TB, K2.0023447

CODEX Compact Drive set 3x2TB, [K0.0040251](#)

CODEX Compact Drive set 6x2TB, [KK.0040353](#)



### CODEX Compact Drive Dock (TB3), K2.0034320 (CODEX# CDX.0001007)



### CODEX Compact Drive 1TB, K2.0024130

CODEX Compact Drive set 3x1TB, [K0.0024596](#)

CODEX Compact Drive set 6x1TB, [KK.0024370](#)

CODEX Compact Drive set 12x1TB, [K0.0048298](#)



### CODEX Compact Drive Reader (USB-C), K2.0024134 (CODEX# CDX.0001005)

## Electronic Accessories



### Audio Extension Module AEM-1, [K2.0023750](#)



### Power Distribution Module PDM-1, [K2.0024101](#)

# ALEXA 35 Xtreme Sets & ALEXA 265 - Support Set Options



Configuration Overview | 1.1.3 / 2025.08

## Production Sets



### Top Accessory Set Production, [KK.0041533](#)

- includes:
- K2.0034178 1x Low Mode Support LMS-4
  - K2.0024062 1x Top Extension Bracket TEB-1
  - K2.0023519 1x Center Camera Handle CCH-5
  - K2.0047906 1x Square Accessory Sleeve SAS-2
  - K2.0033859 1x Viewfinder Mounting Bracket VMB-5



### Production Support Set - Side, [KK.0041534](#)\*\*

- includes:
- K2.0033571 1x Camera Side Bracket CSB-1R
  - K2.0033573 1x Camera Side Bracket CSB-1L
  - K2.0034189 1x Camera Side Bracket CSB-1R Extension
  - K2.0023907 1x Rod Mounting Bracket RMB-7
  - K2.0034182 1x Articulated Mounting Plate AMP-1

### Production Support Set - Bottom (19mm), [KK.0041535](#)

- includes:
- K2.0023549 1x Compact Bridge Plate CBP-5 (19mm)
  - K2.0015896 1x Bottom Dovetail Plate 300mm/12in

### Production Support Set - Bottom (15mm), [KK.0041536](#)

- includes:
- K2.0023836 1x Compact Bridge Plate CBP-6 (15mm)
  - K2.0015896 1x Bottom Dovetail Plate 300mm/12in



## Operator Sets



### Operator Set, [KK.0051696](#)

- includes:
- K2.0049425 1x Top Operator Grip TOG-1
  - K2.0049422 1x Top Operator Plate TOP-1
  - K2.0049959 1x Touchdown Base Plate TBP-1
  - K2.0049960 1x Touchdown Receiver Plate TRP-1

### ALEXA 35 Xtreme Premium Body & LPL Mount Set, [K0.0055024](#)

- includes:
- KK.0055023 1x ALEXA 35 Xtreme with Premium License
  - K2.0034180 1x Balance Utility Dovetail BUD-1
  - K2.0023751 1x B-Mount Battery Adapter
  - K2.0018983 ARRI LPL Lens Mount (LBUS)
  - K2.0016936 ARRI PL-toLPL-Adapter



### ALEXA 35 Xtreme Premium Body & PL Mount Set, [K0.0055025](#)

- includes:
- KK.0055023 1x ALEXA 35 Xtreme with Premium License
  - K2.0034180 1x Balance Utility Dovetail BUD-1
  - K2.0023751 1x B-Mount Battery Adapter
  - K2.0042651 ARRI PL Lens Mount (LBUS)

### MVF-2 Viewfinder Set, [K0.0042899](#)

- includes:
- K2.0020916 1x Multi Viewfinder MVF-2
  - K2.0042857 2x Cable VF Right Angle (0.5m/1.5ft)



### Viewfinder Mounting Set Cross Pipe, [KK.0013311](#)

- includes:
- K2.0013302 1x Viewfinder Cross Pipe
  - K2.0006186 1x Rod Mounting Bracket RMB-3

### Viewfinder Mounting Set VMB-5, [KK.0034527](#)

- includes:
- K2.0033859 1x Viewfinder Mounting Bracket VMB-5
  - K2.0047906 1x Square Accessory Sleeve SAS-2



### Handle Extension Set for ALEXA 35, [KK.0051730](#), includes:

- K2.0019791 1x Handle Extension HEX-1
- K2.0019792 1x Handle Extension HEX-2
- K2.0019797 1x Handle Extension HEX-3
- K2.0019798 1x Handle Extension HEX-4
- K2.0036917 1x Handle Extension HEX-5
- K2.0019810 1x Handle Extension HEX-90
- K2.0037131 1x Wooden Shell for HEX
- K2.0049050 1x Handle Extension HEX-A

## Lightweight Sets



### Lightweight Support Set - Top, [KK.0041537](#)

- includes:
- K2.0034179 1x Universal Adapter Plate UAP-3
  - K2.0024062 1x Top Extension Bracket TEB-1
  - K2.0024066 1x Lightweight Camera Handle LCH-1
  - K2.0034554 1x Balance Harness Adapter BHA-1
  - K2.0023948 1x Lightweight Support LWS-6
  - K2.0006186 1x Rod Mounting Bracket RMB-3
  - K2.0013302 1x Viewfinder Cross Pipe



### Lightweight Support Set - Side, [KK.0041538](#)\*\*

- includes:
- K2.0033571 1x Camera Side Bracket CSB-1R
  - K2.0033573 1x Camera Side Bracket CSB-1L
  - K2.0034189 1x Camera Side Bracket CSB-1R Extension
  - K2.0023907 1x Rod Mounting Bracket RMB-7



### Lightweight Support Set - Bottom, [KK.0041539](#)

- includes:
- K2.0024745 1x Bridge Plate Adapter BPA-6
  - K2.0024161 1x Compact Shoulder Pad CSP-2

\*\* not compatible with ALEXA 265

# ALEXA 35 Xtreme & ALEXA 265 - Single Component Options



Configuration Overview | 1.1.4 / 2025.10

## Camera & Electronic Components



ALEXA 35 Xtreme with Base License, K1.0053455



Multi Viewfinder MVF-2, [K2.0020916](#)



ARRI LPL Mount (LBUS), [K2.0018983](#)



ARRI PL Mount (LBUS), [K2.0042651](#)



ARRI PL Mount (Hirose), [K2.0042652](#)



ARRI EF Mount (LBUS), [K2.0019965](#)



ARRI PL-to-LPL Adapter [K2.0016936](#)



Audio Extension Module AEM-1, [K2.0023750](#)



External Power Adapter EPA-1, [K2.0034205](#)



Power Distribution Module PDM-1, [K2.0024101](#)



B-Mount Battery Adapter, [K2.0023751](#)



Battery Adapter Back BAB-LF, [K2.0034204](#)



Audio Extension Module AEM-1 Set, [K0.0054747](#), includes:  
K2.0023750 1x Audio Extension Module AEM-1  
K2.0054667 1x Audio Breakout AB-7 Right Angle  
K2.0054668 1x Breakout Box Side Mounting Bracket



Audio Breakout AB-7 Right Angle, K2.0054667



Camera Control Monitor CCM-1 Set, [KK.0048851](#), includes  
K2.0048523 1x CCM-1 with Foldable Sunhood, Screen Protector  
K2.0048394 1x Monitor Arm for Camera MAC-1  
K2.0023943 1x Cable VF (0.5m/1.5ft)  
K2.0001637 1x Cable RS - RS/PWR IN (0.5m/1.6ft)



CCM-1 Ethernet Adapter [K2.0048980](#)

## Components Top



Center Camera Handle CCH-5, [K2.0023519](#)



Lightweight Camera Handle LCH-1, [K2.0024066](#)



Universal Adapter Plate UAP-3, [K2.0034179](#)



Top Extension Bracket TEB-1, [K2.0024062](#)



Low Mode Support LMS-4, [K2.0034178](#)



Adjustable Top Plate for MöVI, [K2.0024181](#)



Balance Harness Adapter BHA-1, [K2.0034554](#)



Lightweight Support LWS-6, [K2.0023948](#)



Lightweight Support LWS-7, K2.0050467



Viewfinder Mounting Bracket VMB-5, [K2.0033859](#)



Viewfinder Cross Pipe, [K2.0013302](#)



Vertical Top Plate, [K2.0043666](#)



Square Acc. Sleeve SAS-2, [K2.0047906](#)



Monitor Arm for Camera MAC-1, [K2.0048394](#)



Viewfinder Adapter VFA-3, [K2.0048079](#)



Viewfinder Adapter VFA-4, [K2.0048510](#)



Top Operator Grip TOG-1, K2.0049425



Top Operator Plate TOP-1, K2.0049422



Universal Adapter Plate UAP-5, K2.0052288

\*\* not compatible with ALEXA 265

## Components Side & Rear



Camera Side Bracket CSB-1R Extension, [K2.0034189](#) \*\*



Camera Side Bracket CSB-1L, [K2.0033573](#)



Camera Side Bracket CSB-1R, [K2.0033571](#) \*\*



Breakout Box Side Mounting Bracket, K2.0054668



Rear Accessory Bracket RAB-2, [K2.0034183](#)



Rod Mounting Bracket RMB-7, [K2.0023907](#)



Articulated Mounting Plate AMP-1, [K2.0034182](#)

## Case



Case for ALEXA 35, [K2.0040234](#)

## Storage Media



CODEX Compact Drive 2TB [K2.0023447](#)  
CODEX Compact Drive set 3x2TB, [K0.0040251](#)  
CODEX Compact Drive set 6x2TB, [KK.0040353](#)



CODEX Compact Drive 1TB [K2.0024130](#)  
CODEX Compact Drive set 3x1TB, [K0.0024596](#)  
CODEX Compact Drive set 6x1TB, [KK.0024370](#)  
CODEX Compact Drive set 12x1TB, [K0.0048298](#)



CODEX Compact Drive Express 1TB, [K2.0053843](#)



CODEX Compact Drive Dock (TB3), [K2.0034320](#) (CODEX# CDX.0001007)



CODEX Compact Dr Exp 1TB+Reader Bundle, [K0.0053933](#)



Transcend JF890S USB Flash Drive 64GB, [K2.0043663](#)

## Components Bottom



Balance Utility Dovetail BUD-1, [K2.0034180](#)



Compact Shoulder Pad CSP-2, [K2.0024161](#)



Compact Bridge Plate CBP-5LW (19mm), K2.0049300



Compact Bridge Plate CBP-6LW (15mm), K2.0049301



Compact Bridge Plate CBP-5 (19mm), [K2.0023549](#)



Compact Bridge Plate CBP-6 (15mm), [K2.0023836](#)



Bridge Plate Adapter BPA-6, [K2.0024745](#)



Stabilizer Adapter Mount SAM-5, [K2.0024572](#)



Stabilizer Adapter Mount SAM-6 250mm/10", [K2.0024508](#)



Stabilizer Adapter Mount SAM-6 355mm/14in, [K2.0048425](#)



Stabilizer Adapter Mount SAM-7, [K2.0024511](#)



Stabilizer Adapter Mount SAM-6 450mm/18in, [K2.0039405](#)



Stabilizer Adapter Mount SAM-8, [K2.0044479](#)



Stabilizer Adapter Mount SAM-9, [K2.0041949](#)



Stabilizer Adapter Mount SAM-10, K2.0049873



Universal Adapter Plate UAP-4, K2.0043674



Vertical Format Baseplate, [K2.0042610](#) \*\*



Vertical Format Set for ALEXA 35, [KK.0043836](#) \*\*

# ALEXA 35 Xtreme & ALEXA 265 - Component Options Top



Configuration Overview | 1.1.5 / 2025.08

## Top Components and Viewfinder

**Top Accessory Set Production, [KK.0041533](#)**  
includes:  
K2.0034178 1x Low Mode Support LMS-4  
K2.0024062 1x Top Extension Bracket TEB-1  
K2.0023519 1x Center Camera Handle CCH-5  
K2.0047906 1x Square Accessory Sleeve SAS-2  
K2.0033859 1x Viewfinder Mounting Bracket VMB-5



**Lightweight Support Set - Top, [KK.0041537](#)**  
includes:  
K2.0034179 1x Universal Adapter Plate UAP-3  
K2.0024062 1x Top Extension Bracket TEB-1  
K2.0024066 1x Lightweight Camera Handle LCH-1  
K2.0034554 1x Balance Harness Adapter BHA-1  
K2.0023948 1x Lightweight Support LWS-6  
K2.0006186 1x Rod Mounting Bracket RMB-3  
K2.0013302 1x Viewfinder Cross Pipe



**MVF-2 Viewfinder Set, K0.0042899**  
includes:  
K2.0020916 1x Multi Viewfinder MVF-2  
K2.0042857 2x Cable VF Right Angle (0.5m/1.5ft)



**Viewfinder Mounting Set VMB-5, [KK.0034527](#)**  
includes:  
K2.0033859 1x Viewfinder Mounting Bracket VMB-5  
K2.0047906 1x Square Accessory Sleeve SAS-2



**Camera Control Monitor CCM-1 Set, [KK.0048851](#)**, includes:  
K2.0048523 1x CCM-1 with Foldable Sunhood, Screen Protector  
K2.0048394 1x Monitor Arm for Camera MAC-1  
K2.0023943 1x Cable VF (0.5m/1.5ft)  
K2.0001637 1x Cable RS - RS/PWR IN (0.5m/1.6ft)



Attaches to any receptacles for two 15mm lightweight rods, as can be found in the LMS-4 or LWS-6

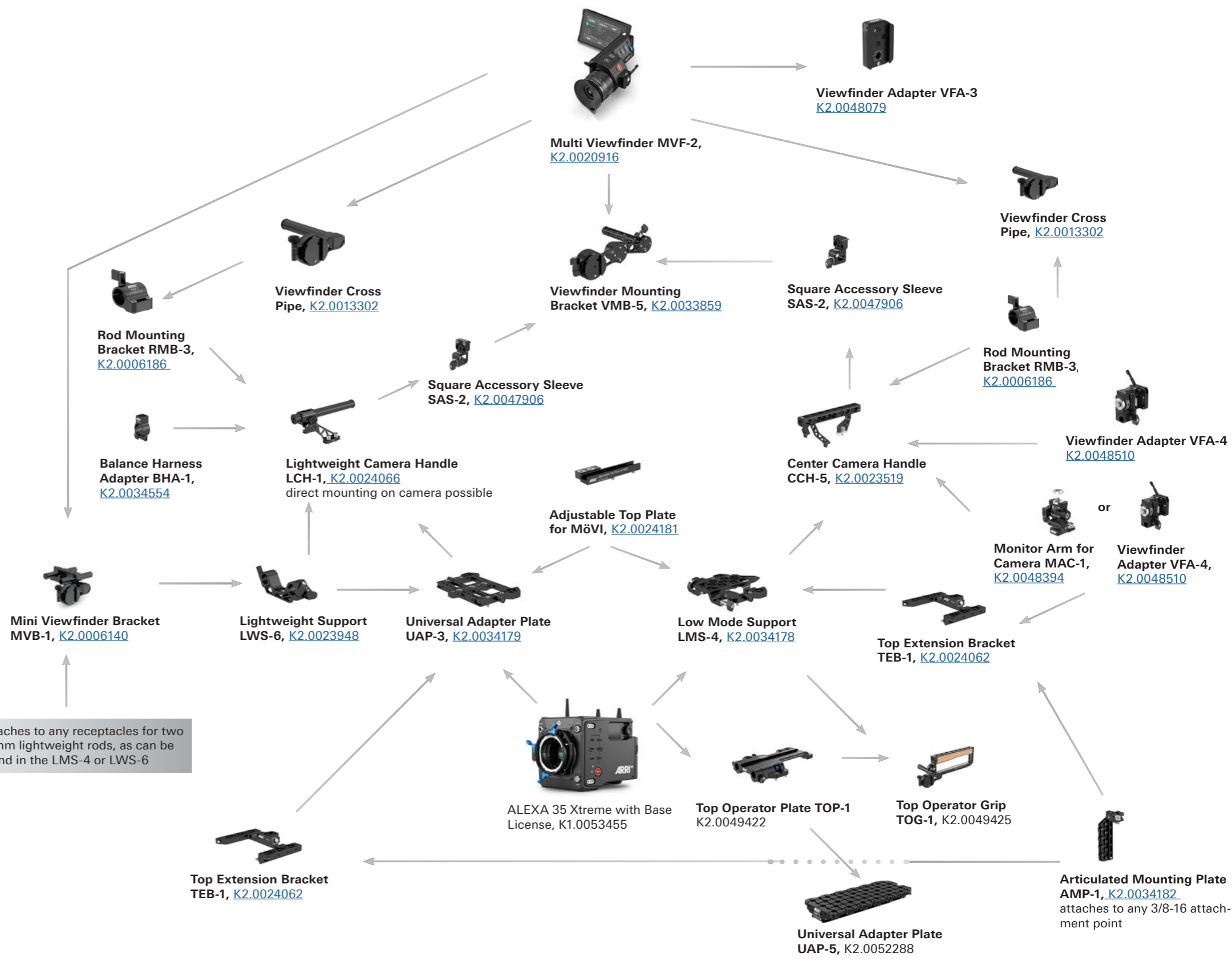

# ALEXA 35 Xtreme & ALEXA 265 - Component Options Side & Rear



Configuration Overview | 1.1.6 / 2025.07

## Side Components

### Production Support Set - Side, [KK.0041534](#) \*\*

- includes:
- K2.0033571 1x Camera Side Bracket CSB-1R
  - K2.0033573 1x Camera Side Bracket CSB-1L
  - K2.0034189 1x Camera Side Bracket CSB-1R Extension
  - K2.0023907 1x Rod Mounting Bracket RMB-7
  - K2.0034182 1x Articulated Mounting Plate AMP-1



### Lightweight Support Set - Side, [KK.0041538](#) \*\*

- includes:
- K2.0033571 1x Camera Side Bracket CSB-1R
  - K2.0033573 1x Camera Side Bracket CSB-1L
  - K2.0034189 1x Camera Side Bracket CSB-1R Extension
  - K2.0023907 1x Rod Mounting Bracket RMB-7



Top Extension Bracket  
TEB-1, [K2.0024062](#)



ALEXA 35 camera body,  
[K1.0039373](#)



Balance Utility Dovetail  
BUD-1, [K2.0034180](#)



Rear Accessory Bracket  
RAB-2, [K2.0034183](#)



Articulated Mounting Plate  
AMP-1, [K2.0034182](#)

A large number of 3/8-16, 1/4-20 and M4 attachment points on a hinged chees plate allow various accessories to be attached



Rod Mounting Bracket  
RMB-7, [K2.0023907](#)



Universal Adapter Plate  
UAP-4, [K2.0043674](#)



Vertical Format Baseplate,  
K2.0042610 \*\*



Camera Side Bracket CSB-1R  
Extension, [K2.0034189](#) \*\*



Camera Side Bracket CSB-1R,  
[K2.0033571](#) \*\*



Vertical Format Set for  
ALEXA 35, [KK.0043836](#) \*\*



Camera Side Bracket  
CSB-1L, [K2.0033573](#)

\*\* not compatible  
with ALEXA 265

\*\* not compatible  
with ALEXA 265

# ALEXA 35 Xtreme & ALEXA 265 - Component Options Bottom



Configuration Overview | 1.1.7 / 2026.03

## Bottom Components

### Production Support Set - Bottom (19mm), [KK.0041535](#)

includes:  
K2.0023549 1x Compact Bridge Plate CBP-5 (19mm)  
K2.0015896 1x Bottom Dovetail Plate 300mm/12in



### Production Support Set - Bottom (15mm), [KK.0041536](#)

includes:  
K2.0023836 1x Compact Bridge Plate CBP-6 (15mm)  
K2.0015896 1x Bottom Dovetail Plate 300mm/12in



### Lightweight Support Set - Bottom , [KK.0041539](#)

includes:  
K2.0024745 1x Bridge Plate Adapter BPA-6  
K2.0024161 1x Compact Shoulder Pad CSP-2



**Touchdown Base Plate TBP-1**, K2.0049959



**Touchdown Receiver Plate TRP-1**, K2.0049960



ALEXA 35 Xtreme with Base License, K1.0053455



**Balance Utility Dovetail BUD-1**, [K2.0034180](#)



**Lightweight Support LWS-7**, K2.0050467



**Universal Adapter Plate UAP-4**, K2.0043674



**Compact Shoulder Pad CSP-2**, [K2.0024161](#)



**Stabilizer Adapter Mount SAM-5**, [K2.0024572](#)

**Stabilizer Adapter Mount SAM-6 250mm/10"**, [K2.0024508](#)

**Stabilizer Adapter Mount SAM-6 355mm/14in**, [K2.0048425](#)

**Stabilizer Adapter Mount SAM-6 450mm/18in**, [K2.0039405](#)

**Stabilizer Adapter Mount SAM-7**, [K2.0024511](#)

**Stabilizer Adapter Mount SAM-8**, [K2.0044479](#)

**Stabilizer Adapter Mount SAM-9**, [K2.0041949](#)

**Stabilizer Adapter Mount SAM-10**, K2.0049873



**Bridge Plate Adapter BPA-6**, [K2.0024745](#)



**Lightweight Tripod Plate LTP-1**, K2.0055367



**Compact Bridge Plate CBP-5LW (19mm)**, K2.0049300



**Compact Bridge Plate CBP-6LW (15mm)**, K2.0049301



**Compact Bridge Plate CBP-6 (15mm)**, [K2.0023836](#)



**Compact Bridge Plate CBP-5 (19mm)**, [K2.0023549](#)

Unscrew Touch 35 bottom to use



**Bridge Plate BP-8 19 mm**, [K2.0031436](#)



**Bridge Plate BP-9 15 mm**, [K2.0031435](#)



**Compact Shoulder Pad CSP-2**, [K2.0024161](#)

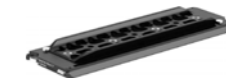

**Bottom Dovetail Plate 300mm/12in**, [K2.0015896](#)

# ALEXA 35 Xtreme & ALEXA 265 - Powered Component Options



Configuration Overview | 1.1.8 / 2025.10

## Storage Media



**CODEX Compact Drive Express 1TB,**  
[K2.0053843](#)  
**CODEX Compact Dr Exp 1TB+Reader**  
**Bundle, [K0.0053933](#)**



**CODEX Compact Drive 2TB**  
[K2.0023447](#)  
**CODEX Compact Drive set 3x2TB**  
[K0.0040251](#)  
**CODEX Compact Drive set 6x2TB**  
[KK.0040353](#)



**CODEX Compact Drive 1TB**  
[K2.0024130](#)  
**CODEX Compact Drive set 3x1TB**  
[K0.0024596](#)  
**CODEX Compact Drive set 6x1TB**  
[KK.0024370](#)  
**CODEX Compact Drive set 12x1TB**  
[KK.0048298](#)

Most Compact Drive 1TB need a firmware update, which can be applied by ALEXA 35 in-camera



**CODEX Compact Drive Dock (TB3)**  
[K2.0034320](#) (Codex# CDX.0001007)



**CODEX Compact Drive Reader (USB-C)**  
[K2.0024134](#) (Codex# CDX.0001005)

## Powered Components

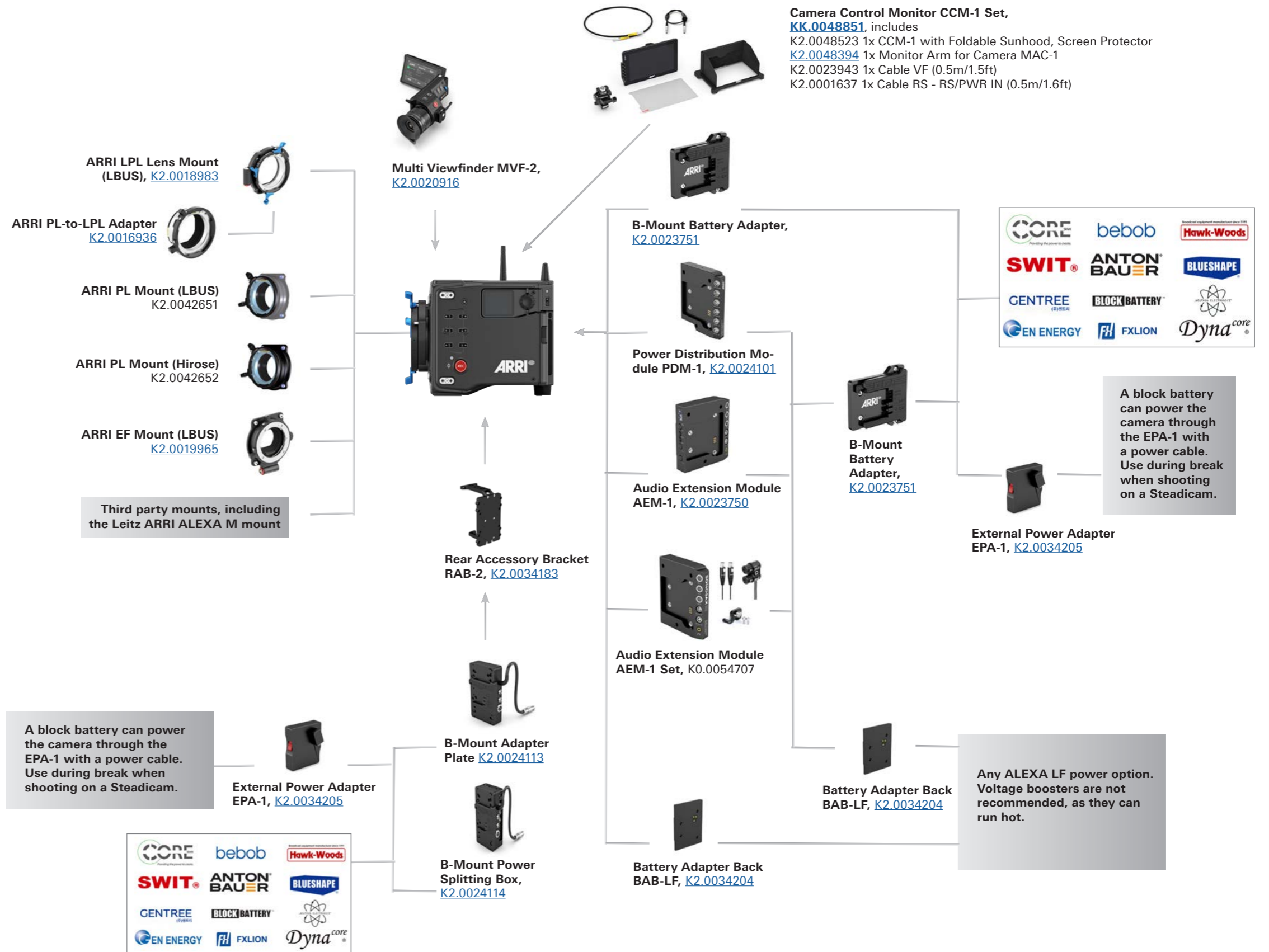

# ALEXA 35 Xtreme & ALEXA 265 - Stabilizer Adapter Mount SAM



Configuration Overview | 1.1.9 / 2025.07

The Stabilizer Adapter Mount SAM-10 is not displayed on this page. See page 1.1.7

MöVI M15  
MöVI Pro



Adjustable Top Plate  
[K2.0024181](#)

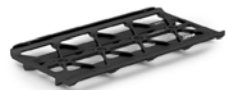

Stabilizer Adapter Mount  
SAM-5, [K2.0024572](#)

ARRI TRINITY Gen.1/2  
ARRI MAXIMA  
ARRI ARTEMIS 2



Stabilizer Adapter Mount  
SAM-6 250mm/10",  
[K2.0024508](#)

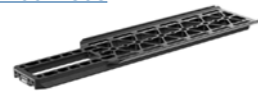

Stabilizer Adapter Mount  
SAM-6 355mm/14in,  
[K2.0048425](#)

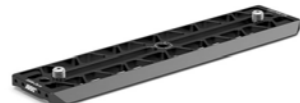

Stabilizer Adapter Mount  
SAM-Zero, [K2.0041201](#)



Dovetail Utility Base  
DUB-1, [K2.0039861](#)

The SAM-6 450mm/18in fits the ARRI TRINITY 1/2, MAXIMA and Artemis 2 stabilizers, however the 450mm plate is designed to support longer camera builds on SRH-3/360 and may compromise movements on body held stabilizers.

ARRI artemis 1  
GPi PRO Stabilizers



Stabilizer Adapter Mount  
SAM-7, [K2.0024511](#)

Tiffen Steadicam  
M1, M2, Volt



Stabilizer Adapter Mount  
SAM-8, [K2.0044479](#)



Dovetail Utility Base  
DUB-2, [K2.0044813](#)

SAM-7 and SAM-8 have the same dovetail size. The SAM-8 is longer and features bottom safety stops optimized for Tiffen Steadicam units

ARRI SRH-360  
ARRI SRH-3



Stabilizer Adapter Mount  
SAM-6 450mm/18in,  
[K2.0039405](#)



Rod Mounting Bracket  
RMB-9, [K2.0049530](#)



Stabilizer System Bracket  
SSB-2 19mm, [K2.0038537](#)

Stabilizer System Bracket  
SSB-2 15mm, [K2.0038618](#)



Stabilizer Adapter Mount  
SAM-6 250mm/10",  
[K2.0024508](#)

The long SAM-6 (450mm) supports long zooms, e.g. Signature Zoom 65-300mm, on the ARRI SRH heads.

Dji Ronin 2



Stabilizer Adapter Mount  
SAM-9, [K2.0041949](#)



Adapter Ronin 2 to Camera  
Top Plate, [K2.0048854](#)



Adjustable Top Plate  
[K2.0024181](#)

## ALEXA Mini LF Ready to Shoot Sets



**ALEXA Mini LF Ready to Shoot Set V, [K0.0024313](#)**  
**ALEXA Mini LF Ready to Shoot Set Gold, [K0.0024312](#)**  
**ALEXA Mini LF Ready to Shoot Set B, [K0.0024852](#)**

- includes:
- K1.0024074 1x ALEXA Mini LF camera body
  - K2.0018983 1x ARRI LPL Mount (LBUS)
  - K2.0016936 1x ARRI PL-to-LPL Adapter
  - K2.0024130 2x Codex Compact Drive 1TB (CA08-1024)
  - K2.0020916 1x ALEXA Mini LF Multi Viewfinder MVF-2
  - K2.0023915 1x Cable VF (0.35m/1.15ft)
  - K2.0023943 1x Cable VF (0.5m/1.5ft)
  - K2.0023839 1x Mini Adapter Plate MAP-2A
  - K2.0006140 1x Mini Viewfinder Bracket MVB-1
  - K2.73002.0 1x Center Camera Handle CCH-2
  - K2.0023546 1x Mini Side Bracket MSB-3
  - K2.0014957 1x Mini Side Bracket MSB-2
  - K2.0014894 1x Compact Bridge Plate CBP-1 19mm
  - K2.0013937 1x Rear Accessory Bracket RAB-1
  - K2.0023406 1x RAB-1 Clamp 2
  - K2.0006186 1x Rod Mounting Bracket RMB-3
  - K2.66255.0 1x 15mm Reduction Insert
  - K2.0015896 1x Bottom Dovetail Plate 300mm/12in
  - K2.75007.0 1x AMIRA Power Cable Straight 2m/6.6in KC-50
- Set V:** K2.0014530 1x V-mount Power Splitting Box MkII **OR**  
**Set G:** K2.0014532 1x Gold Mount Power Splitting Box Mk II **OR**  
**Set B:** K2.0024114 1x B-Mount Power Splitting Box

for further sets please see current price list

## ALEXA Mini LF with MVF-2 Sets



**ALEXA Mini LF Production Set 19 - MVF-2, [K0.0049871](#)**  
 includes:

- 1x K1.0024074 ALEXA Mini LF camera body
- 1x K2.0018983 ARRI LPL Lens Mount ALEXA Mini/AMIRA
- 1x K2.0016936 PL-to-LPL-Adapter
- 3x K2.0024130 Codex Compact Drive 1TB (CA08-1024)
- 1x K2.0020916 ALEXA Mini LF Multi Viewfinder MVF-2
- 1x K2.0023915 Cable VF (0.35m/1.15ft)
- 1x K2.0023943 Cable VF (0.5m/1.5ft)
- 1x K2.0048463 Balance Utility Dovetail BUD-3
- 1x K2.0023839 Mini Adapter Plate MAP-2A
- 1x K2.0033859 Viewfinder Mounting Bracket VMB-5
- 1x K2.0047906 Square Accessory Sleeve SAS-2
- 1x K2.0017270 Center Camera Handle CCH-4
- 1x K2.0019792 Handle Extension HEX-2
- 1x K2.0019797 Handle Extension HEX-3
- 1x K2.0012692 Side Accessory Bracket SAB-1
- 1x K2.0023546 Mini Side Bracket MSB-3
- 1x K2.0014957 Mini Side Bracket MSB-2
- 1x K2.0023549 Compact Bridge Plate CBP-5 (19mm)
- 1x K2.0049215 Rear Accessory Bracket RAB-3
- 1x K2.0023406 Clamp 2 for RAB-1
- 1x K2.0015896 Bottom Plate 300mm/12"
- 1x K2.75007.0 Power Cable Straight KC-50 2m

**ALEXA Mini LF Production Set 15 - MVF-2, [K0.0049869](#)**  
 includes:

- 1x K1.0024074 ALEXA Mini LF camera body
- 1x K2.0018983 ARRI LPL Lens Mount ALEXA Mini/AMIRA
- 1x K2.0016936 PL-to-LPL-Adapter
- 3x K2.0024130 Codex Compact Drive 1TB (CA08-1024)
- 1x K2.0020916 ALEXA Mini LF Multi Viewfinder MVF-2
- 1x K2.0023915 Cable VF (0.35m/1.15ft)
- 1x K2.0023943 Cable VF (0.5m/1.5ft)
- 1x K2.0048463 Balance Utility Dovetail BUD-3
- 1x K2.0023839 Mini Adapter Plate MAP-2A
- 1x K2.0033859 Viewfinder Mounting Bracket VMB-5
- 1x K2.0047906 Square Accessory Sleeve SAS-2
- 1x K2.0017270 Center Camera Handle CCH-4
- 1x K2.0019792 Handle Extension HEX-2
- 1x K2.0019797 Handle Extension HEX-3
- 1x K2.0012692 Side Accessory Bracket SAB-1
- 1x K2.0023546 Mini Side Bracket MSB-3
- 1x K2.0014957 Mini Side Bracket MSB-2
- 1x K2.0023836 Compact Bridge Plate CBP-6 (15mm)
- 1x K2.0049215 Rear Accessory Bracket RAB-3
- 1x K2.0023406 Clamp 2 for RAB-1
- 1x K2.0015896 Bottom Plate 300mm/12"
- 1x K2.75007.0 Power Cable Straight KC-50 2m

## ALEXA Mini LF with CCM-1 Sets



**ALEXA Mini LF Production Set 19 - CCM-1, [K0.0049870](#)**  
 includes:

- 1x K1.0024074 ALEXA Mini LF camera body
- 1x K2.0018983 ARRI LPL Lens Mount ALEXA Mini/AMIRA
- 1x K2.0016936 PL-to-LPL-Adapter
- 3x K2.0024130 Codex Compact Drive 1TB (CA08-1024)
- 1x KK.0048851 Camera Control Monitor CCM-1 set
- 1x K2.0023915 Cable VF (0.35m/1.15ft)
- 1x K2.0048463 Balance Utility Dovetail BUD-3
- 1x K2.0023839 Mini Adapter Plate MAP-2A
- 1x K2.0017270 Center Camera Handle CCH-4
- 1x K2.0019792 Handle Extension HEX-2
- 1x K2.0019797 Handle Extension HEX-3
- 1x K2.0012692 Side Accessory Bracket SAB-1
- 1x K2.0023546 Mini Side Bracket MSB-3
- 1x K2.0014957 Mini Side Bracket MSB-2
- 1x K2.0023549 Compact Bridge Plate CBP-5 (19mm)
- 1x K2.0049215 Rear Accessory Bracket RAB-3
- 1x K2.0023406 Clamp 2 for RAB-1
- 1x K2.0015896 Bottom Plate 300mm/12"
- 1x K2.75007.0 Power Cable Straight KC-50 2m

**ALEXA Mini LF Production Set 15 - CCM-1, [K0.0049868](#)**  
 includes:

- 1x K1.0024074 ALEXA Mini LF camera body
- 1x K2.0018983 ARRI LPL Lens Mount ALEXA Mini/AMIRA
- 1x K2.0016936 PL-to-LPL-Adapter
- 3x K2.0024130 Codex Compact Drive 1TB (CA08-1024)
- 1x KK.0048851 Camera Control Monitor CCM-1 set
- 1x K2.0023915 Cable VF (0.35m/1.15ft)
- 1x K2.0048463 Balance Utility Dovetail BUD-3
- 1x K2.0023839 Mini Adapter Plate MAP-2A
- 1x K2.0017270 Center Camera Handle CCH-4
- 1x K2.0019792 Handle Extension HEX-2
- 1x K2.0019797 Handle Extension HEX-3
- 1x K2.0012692 Side Accessory Bracket SAB-1
- 1x K2.0023546 Mini Side Bracket MSB-3
- 1x K2.0014957 Mini Side Bracket MSB-2
- 1x K2.0023836 Compact Bridge Plate CBP-6 (15mm)
- 1x K2.0049215 Rear Accessory Bracket RAB-3
- 1x K2.0023406 Clamp 2 for RAB-1
- 1x K2.0015896 Bottom Plate 300mm/12"
- 1x K2.75007.0 Power Cable Straight KC-50 2m

## ALEXA Mini Expansion Sets



**ALEXA Mini LF Lightweight Expansion Set, [K0.0049867](#)**  
 includes:

- 1x K2.0047697 Mini Adapter Plate MAP-4
- 1x K2.0024066 Lightweight Camera Handle LCH-1
- 1x K2.0034554 Balance Harness Adapter BHA-1
- 1x K2.0023948 Lightweight Support LWS-6
- 1x K2.0024745 Bridge Plate Adapter BPA-6
- 1x K2.0024161 Compact Shoulder Pad CSP-2
- 1x K2.0006186 Rod Mounting Bracket RMB-3
- 1x K2.0013302 Viewfinder Cross Pipe



**ALEXA Mini LF Ready to Shoot Expansion Set, [K0.0024684](#)**  
 includes:

- 1x K2.0014981 Stabilizer Plate for CBP
- 1x K2.0001017 Handle Extension Block long, HEB-3
- 1x K2.0023942 Battery Adapter Plate BAP-2A
- 1x K2.0014960 Single Support Rod 90mm, 3.5in, Ø19mm
- 1x K2.0014961 Single Support Rod 150mm, 5.9in, Ø19mm
- 1x K2.0012692 Side Accessory Bracket SAB-1



**Antenna Video/ECS, [K2.0014568](#)**

## Configuration Overview | 1.2.1 / 2024.07

### ALEXA Mini LF



**ALEXA Mini LF Ready to Shoot Set V, [K0.0024313](#)**  
**ALEXA Mini LF Ready to Shoot Set Gold, [K0.0024312](#)**

includes:

- K1.0024074 1x ALEXA Mini LF camera body
- K2.0018983 1x ARRI LPL Mount (LBUS)
- K2.0016936 1x ARRI PL-to-LPL Adapter
- K2.0024130 2x Codex Compact Drive 1TB (CA08-1024)
- K2.0020916 1x ALEXA Mini LF Multi Viewfinder MVF-2
- K2.0023915 1x Cable VF (0.35m/1.15ft)
- K2.0023943 1x Cable VF (0.5m/1.5ft)
- K2.0023839 1x Mini Adapter Plate MAP-2A
- K2.0006140 1x Mini Viewfinder Bracket MVB-1
- K2.73002.0 1x Center Camera Handle CCH-2
- K2.0023546 1x Mini Side Bracket MSB-3
- K2.0014957 1x Mini Side Bracket MSB-2
- K2.0014894 1x Compact Bridge Plate CBP-1 19mm
- K2.0013937 1x Rear Accessory Bracket RAB-1
- K2.0023406 1x RAB-1 Clamp 2
- K2.0006186 1x Rod Mounting Bracket RMB-3
- K2.66255.0 1x 15mm Reduction Insert
- K2.0015896 1x Bottom Dovetail Plate 300mm/12in
- K2.75007.0 1x AMIRA Power Cable Straight 2m/6.6in KC-50
- Set V:** K2.0014530 1x V-mount Power Splitting Box MkII
- Set G:** K2.0014532 1x Gold Mount Power Splitting Box Mk II

OR

for further sets please see current price list

**Antenna Video/ECS, [K2.0014568](#)**



### ALEXA Mini LF Viewfinder

**ALEXA Mini LF MVF-2 Set**

- K0.0024311, includes:
- K2.0020916 1x Multi Viewfinder MVF-2
- K2.0023915 1x Cable VF (0.35m/1.15ft)
- K2.0023943 1x Cable VF (0.5m/1.5ft)



**Heated Eycup, HE-7**  
K2.0003898 (below 0°C)

- Cable VF (0.35m/1.15ft),** K2.0023915
- Cable VF (0.5m/1.5ft),** K2.0023943
- Cable VF (2m/6.5ft),** K2.0023944
- Cable VF (10m/33ft),** K2.0023945

### ALEXA Mini LF Media and Readers



For details regarding Recording Medias please see Configuration Overview 1.9.0

### Lens Mounts and Adapter

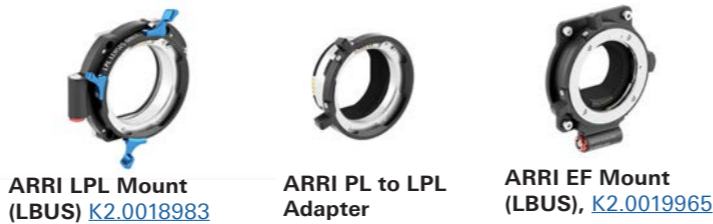

**ARRI LPL Mount (LBUS)** [K2.0018983](#)

**ARRI PL to LPL Adapter**  
[K2.0016936](#)

**ARRI EF Mount (LBUS),** [K2.0019965](#)

### CCM-1 Camera Control Monitor

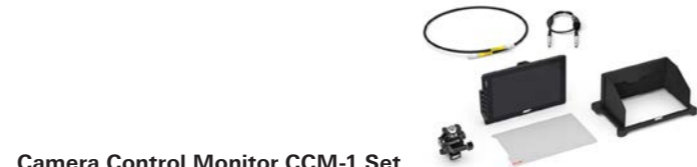

**Camera Control Monitor CCM-1 Set, [KK.0048851](#)**, includes  
 K2.0048523 1x CCM-1 with Foldable Sunhood, Screen Protector  
[K2.0048394](#) 1x Monitor Arm for Camera MAC-1  
 K2.0023943 1x Cable VF (0.5m/1.5ft)  
 K2.0001637 1x Cable RS - RS/PWR IN (0.5m/1.6ft)

**CCM-1 Ethernet Adapter**  
K2.0048980

**Viewfinder Adapter VFA-4**  
K2.0048510

### Electronic Accessories

**Transvideo Starlite HD5-ARRI 5" OLED Monitor** [K2.0006960](#)

**Starlite HD5 ARRI Ext cable angled,** [K2.0008662](#)  
**Starlite HD5 ARRI Ext cable straight,** [K2.0008663](#)

**Transvideo Starlite ARRI-WVS**  
[K2.0015243](#)

**General Purpose IO Box GPB-1,** [K2.0007642](#) (cable incl.)

**GPB-1 Mounting Bracket,** K2.0008533

**Cable ALEXA Mini/AMIRA EXT to GPB-1,** [K2.0007736](#)

### Splitting Boxes and Adapter Plates

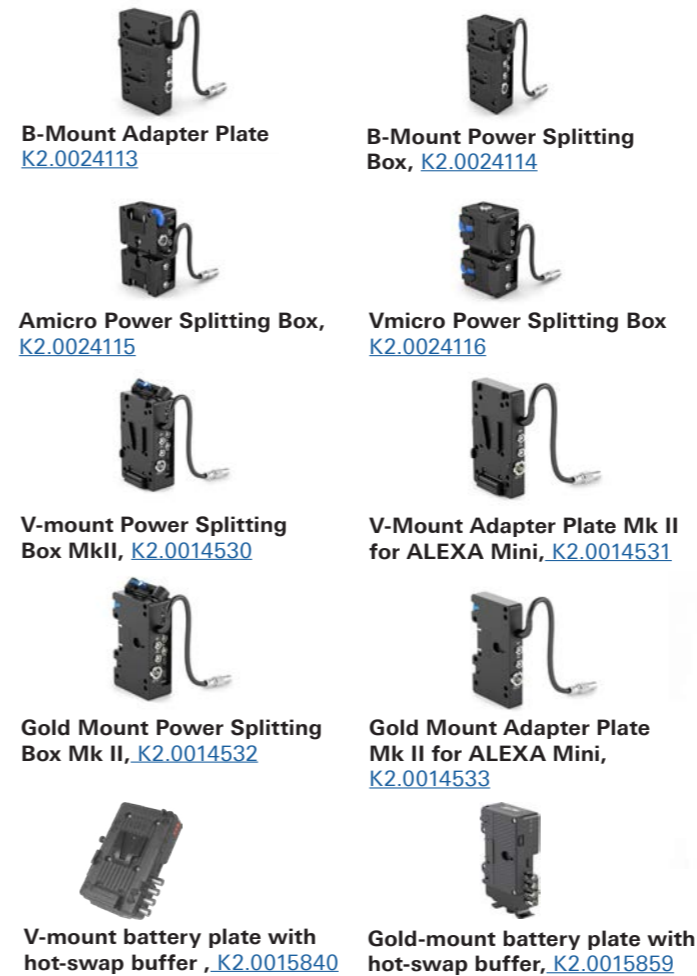

**B-Mount Adapter Plate**  
[K2.0024113](#)

**B-Mount Power Splitting Box,** [K2.0024114](#)

**Amicro Power Splitting Box,** [K2.0024115](#)

**Vmicro Power Splitting Box**  
[K2.0024116](#)

**V-mount Power Splitting Box MkII,** [K2.0014530](#)

**V-Mount Adapter Plate Mk II for ALEXA Mini,** [K2.0014531](#)

**Gold Mount Power Splitting Box Mk II,** [K2.0014532](#)

**Gold Mount Adapter Plate Mk II for ALEXA Mini,** [K2.0014533](#)

**V-mount battery plate with hot-swap buffer,** [K2.0015840](#)

**Gold-mount battery plate with hot-swap buffer,** [K2.0015859](#)

**Power Cable Smart APU to ALEXA Mini 6' (1.85m),** K2.0015861  
**Power Cable Smart APU to ALEXA Mini 2.6' (0.80m),** K2.0015862  
**Power Cable Smart APU to ALEXA Mini (0.25m),** K2.0015863

no pic available yet **Top support rod bracket 15mm LWS**  
K2.0015865

### Cables & Power Supply

**ARRI Power Supply Light 24V** K2.0034493

**Power Cable Straight KC-50 (2m, 6.6 feet),** [K2.75007.0](#)

**Ethernet Cable 3m KC 153-S,** [K2.72021.0](#)  
**ALEXA Mini LF Audio connector with cable,** K2.0023988  
**ALEXA Mini EXT to LCS,** [K2.0007624](#)  
**ALEXA Mini EXT to EXT cable 1,5m (59 inch),** K2.0009051

**EXT-RS Adapter,** [K2.0006170](#)

### Electronic Control System

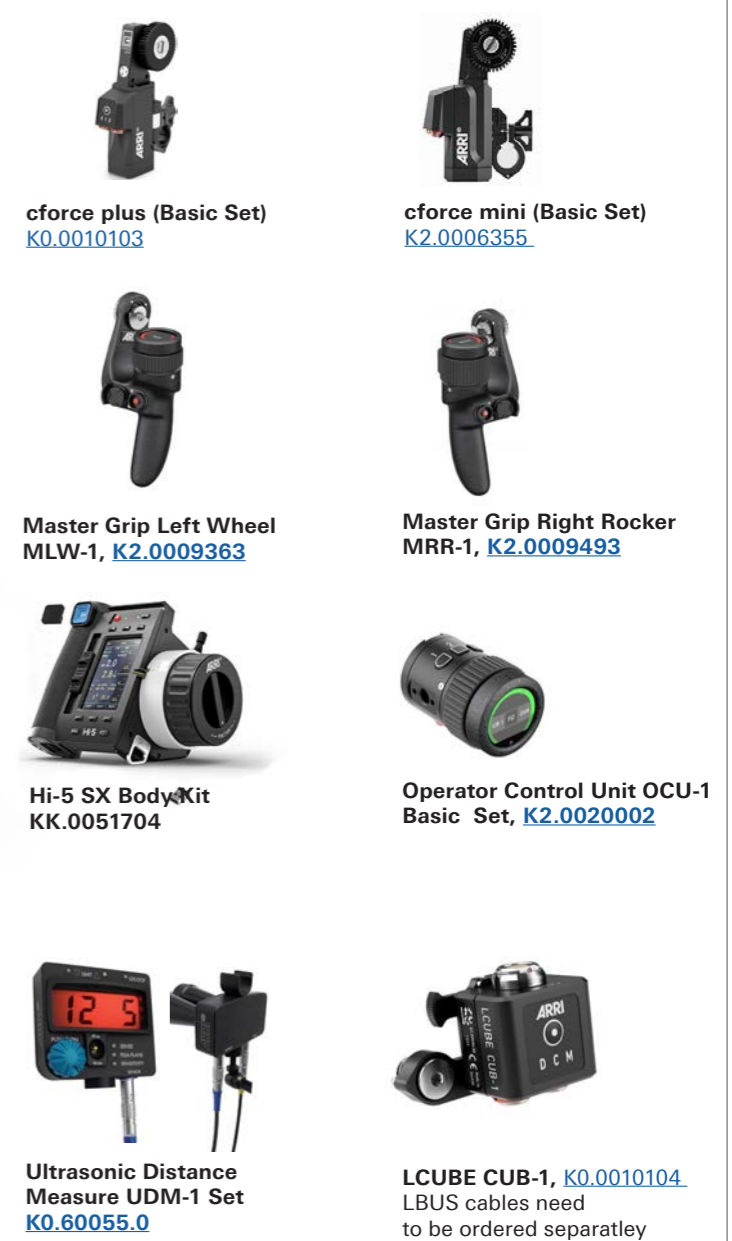

**cforce plus (Basic Set)**  
[K0.0010103](#)

**cforce mini (Basic Set)**  
[K2.0006355](#)

**Master Grip Left Wheel MLW-1,** [K2.0009363](#)

**Master Grip Right Rocker MRR-1,** [K2.0009493](#)

**Hi-5 SX Body Kit**  
KK.0051704

**Operator Control Unit OCU-1 Basic Set,** [K2.0020002](#)

**Ultrasonic Distance Measure UDM-1 Set**  
[K0.60055.0](#)

**LCUBE CUB-1,** [K0.0010104](#)  
LBUS cables need to be ordered separately

- LBUS 0.2m/8",** [K2.0006749](#)
- LBUS 0.3m/1ft,** [K2.0006750](#)
- LBUS 0.5m/1.5ft,** [K2.0006751](#)
- LBUS 0.8m/2.5ft,** [K2.0006752](#)
- LBUS 1.5m/5ft,** [K2.0006753](#)
- LBUS 3m/10ft,** [K2.0006754](#)
- LBUS 6m/20ft,** [K2.0006755](#)
- LBUS 15m/49ft,** [K2.0006756](#)

- Cable LBUS to D-Tap 1.2m/4ft,** [K2.0006757](#)
- Cable LBUS to D-Tap 0.8m/2.5ft,** [K2.0006758](#)
- Cable LBUS to RS 0.8m/2.5ft,** [K2.0006759](#)
- Cable LBUS to XLR-4 0.8m/2.5ft,** [K2.0006760](#)

# ALEXA Mini LF - Mechanical Accessories



Configuration Overview | 1.2.2 / 2024.01

## ALEXA Mini LF



### ALEXA Mini LF & Lens Mount Set, [K0.0024310](#)

Includes:  
 K1.0024074 1x ALEXA Mini LF camera body  
 K2.0018983 1x ARRI LPL Mount (LBUS)  
 K2.0016936 1x ARRI PL-to-LPL Adapter

## Accessories



### Vertical Adapter Set for ALEXA Mini LF

[KK.0024136](#) Includes:  
 K2.0024165 1x Vertical Top Plate for ALEXA Mini LF  
 K2.0019442 1x Vertical Format Adapters (4x brackets)  
 K2.0019443 1x Vertical Viewfinder Adapter



15 mm Reduction Insert  
[K2.66255.0](#)



LBS-2 Handgrip Set  
 without on/off  
 K0.0000465



Camera and Accessory  
 Case, [K2.0001241](#)



Wetsuit for ALEXA Mini,  
[K2.0010053](#)

## ALEXA Mini LF Mechanical Accessories

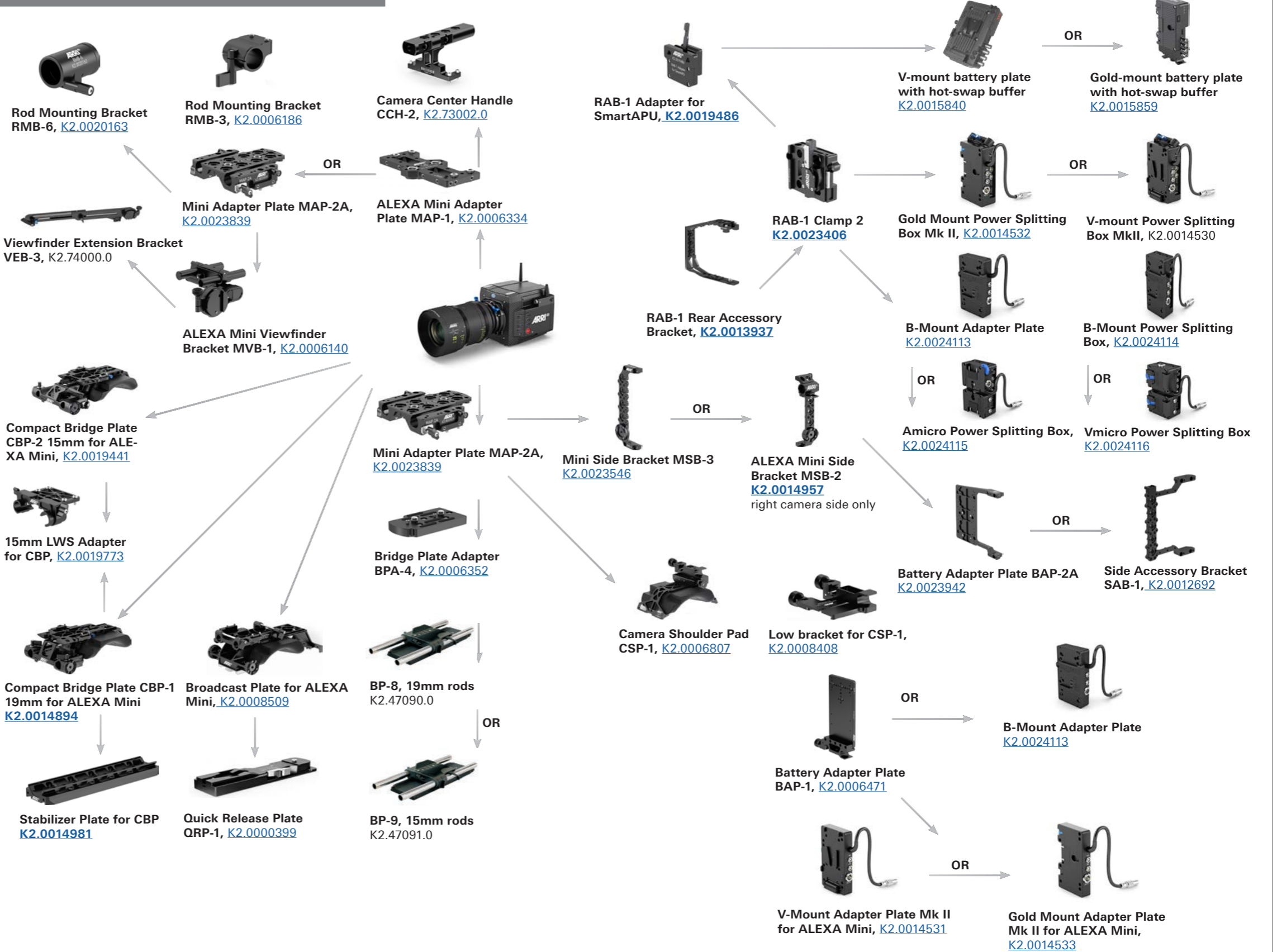

# ALEXA Mini LF - compatible Mechanical Accessories for ALEXA 35



Configuration Overview | 1.2.3 / 2024.11

## ALEXA Mini LF



### ALEXA Mini LF & Lens Mount Set, [K0.0024310](#)

Includes:  
 K1.0024074 1x ALEXA Mini LF camera body  
 K2.0018983 1x ARRI LPL Mount (LBUS)  
 K2.0016936 1x ARRI PL-to-LPL Adapter

## Accessories



### Vertical Adapter Set for ALEXA Mini LF

[KK.0024136](#) Includes:  
 K2.0024165 1x Vertical Top Plate for ALEXA Mini LF  
 K2.0019442 1x Vertical Format Adapters (4x brackets)  
 K2.0019443 1x Vertical Viewfinder Adapter



15 mm Reduction Insert  
[K2.66255.0](#)



LBS-2 Handgrip Set  
 without on/off  
 K0.0000465



Camera and Accessory  
 Case, [K2.0001241](#)



Wetsuit for ALEXA Mini LF,  
[K2.0036013](#)

## ALEXA Mini LF & Mechanical Accessories for ALEXA 35

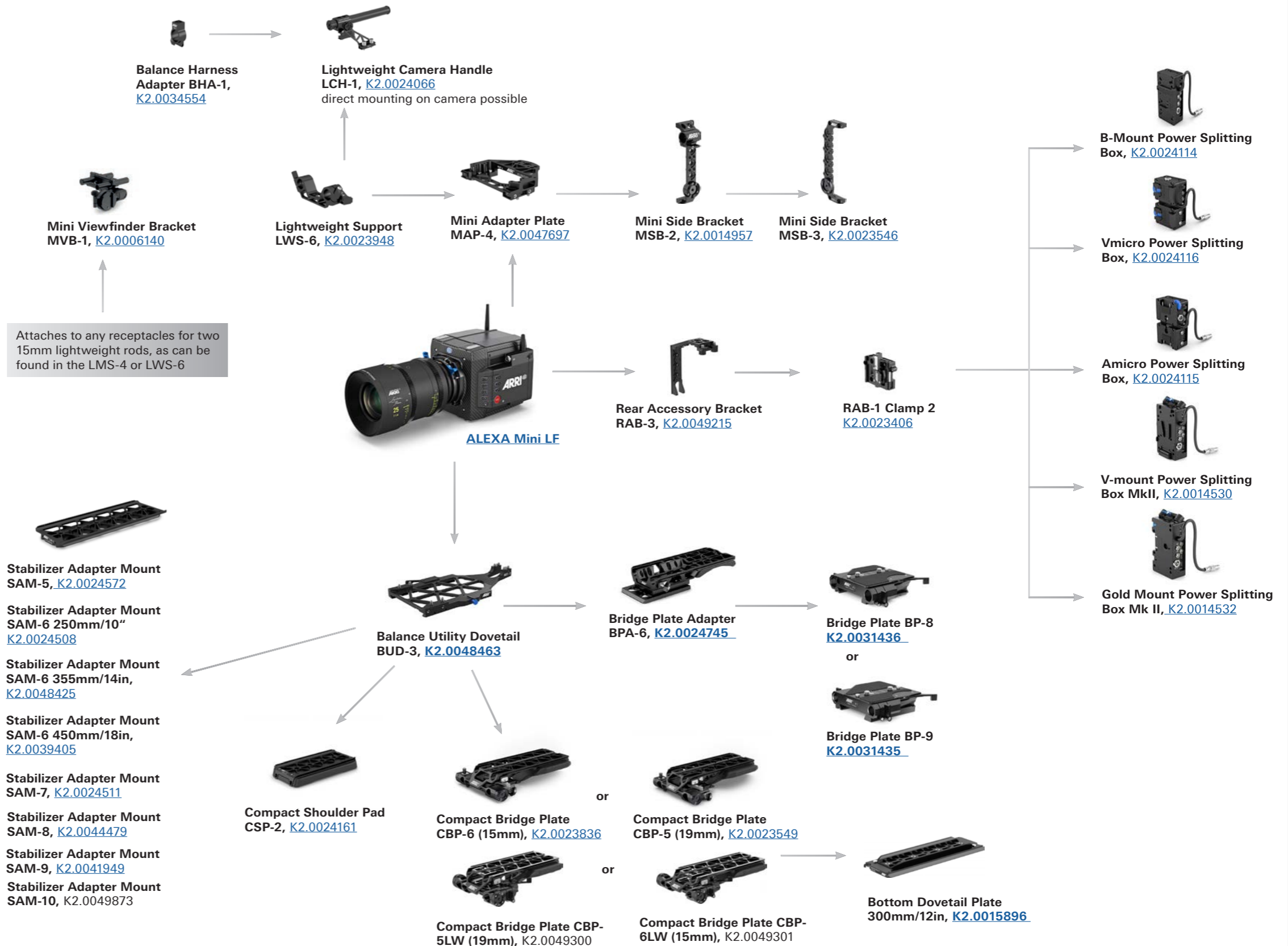

### ALEXA LF Camera Sets



ALEXA Pro Camera Sets contain an ALEXA camera, sufficient media and a number of must-have accessories to get you up and shooting quickly.

#### ALEXA LF Basic Camera Set, [K0.0019228](#)

Includes:  
 K1.0014861 1x ALEXA LF camera body  
 K2.0008429 1x Codex SXR Capture Drive Adapter  
 K2.0006338 1x Codex SxS to SXR Adapter  
 K2.72018.0 1x Transcend SD card  
 K2.72008.0 1x ALEXA Electronic Viewfinder EVF-1  
 K2.74001.0 1x Viewfinder Mounting Bracket VMB-3  
 K2.72012.0 1x Viewfinder Cable Short (0.35m/1.2ft) KC 150-S  
 K2.72007.0 1x Center Camera Handle (CCH-1)  
 K2.0016936 1x ARRI PL-to-LPL Adapter  
 KK.0015010 1x Wireless Video Receiver WVR-1, Basic Set

#### ALEXA LF Pro Camera Set, 1 TB, [KB.72010.D](#)

Includes:  
 K0.0018830 1x ALEXA LF Basic Camera Set for Pro Set (1 TB)  
 K2.0006942 4x SXR Capture Drive 1TB  
 K2.0018790 1x ALEXA LPL LF FSND Filter Set, Full  
 K0.71030.0 1x ALEXA Bundle Accessory Set (EV/Plus/W/LF)

#### ALEXA LF Pro Camera Set, 2 TB, [KB.72020.D](#)

Includes:  
 K0.0018832 1x ALEXA LF Basic Camera Set for Pro Set (2 TB)  
 K2.0006157 4x Codex SXR Capture Drive 2TB  
 K2.0018790 1x ALEXA LPL LF FSND Filter Set, Full  
 K0.71030.0 1x ALEXA Bundle Accessory Set (EV/Plus/W/LF)

#### ALEXA LF Pro Camera Set (SxS Pro+ 256 GB), [KB.72030.D](#)

Includes:  
 K0.0018833 1x ALEXA LF Basic Camera Set for Pro Set, SxS Pro+ 256 GB  
 K2.0014951 5x Sony SxS PRO+ Card 256GB  
 K2.0018790 1x ALEXA LPL LF FSND Filter Set, Full  
 K0.71030.0 1x ALEXA Bundle Accessory Set (EV/Plus/W/LF)

#### ALEXA Bundle Accessory Set (EV/Plus/W/LF), [K0.71030.0](#)

Includes:  
 K2.72021.0 1x Cable ALEXA ETH/RJ45 (3.0m/9.8ft) KC 153-S  
 K2.72017.0 1x Leveling Block LB-1  
 K2.74000.0 1x Viewfinder Extension Bracket VEB-3  
 K2.66172.0 1x Bridge Plate Adapter BPA-2  
 K2.72031.0 1x ALEXA 12V Accessory Cable KC 154-SP-S  
 K2.72083.0 1x Shoulder Pad SP-4  
 K2.72013.0 1x Viewfinder Cable Medium (0.65m/2.1ft) KC 151-S  
 K2.72015.0 1x Handle Extension Block HEB-2

Note 1: Docks or on-board battery adapters are not included and can be ordered separately.  
 Note 2: For use with LF FSND filters, the included FSND shim has to be installed to assure proper flange focal depth.

### Viewfinder System



ALEXA Electronic Viewfinder EVF-2, K2.008397

Viewfinder Cable  
 35 cm, KC 150-S [K2.72012.0](#)  
 65 cm, KC 151-S [K2.72013.0](#)



Viewfinder Extension Bracket VEB-3, [K2.74000.0](#)



Viewfinder Mounting Bracket, VMB-3 [K2.74001.0](#)



Heated Eycup, HE-7 K2.0003898

### LPL Mounts



ARRI LPL Mount ALEXA [K2.0019072](#)



ARRI PL to LPL Adapter [K2.0016936](#)

### Media & Adapters



For details regarding Recording Medias please see Configuration Overview 1.9.0

### Accessories



Remote Control Unit RCU-4, K2.72036.0 (incl. ALEXA Ethernet Remote Cable (2m/6.6ft) KC 157-S K2.72040.0)



Transvideo Starlite ARRI-WVS [K2.0015243](#)



Bridge Plate Set BP-8, 19mm rods, K2.47090.0  
 BP-9, 15mm rods, K2.47091.0  
 BPA-2 needed



Bridge Plate Adapter BPA-2 (for BP-3, 5, 8 or 9) [K2.66172.0](#)



Universal Adapter Plate UAP-1 [K2.72102.0](#)



Wedge Adapter, WA-1 (for Quick Release HD-Baseplate) [K2.72002.0](#) (spare)



Quick Release HD Baseplate [K2.47796.0](#)



Shoulder Pad SP-4 [K2.72083.0](#)



Rod Mounting Bracket RMB-2, [KK.0005807](#)



Centre Camera Handle CCH-1, [K2.72007.0](#) (spare)



Side Camera Handle, SCH-1 [K2.72016.0](#)



Adjustable Center Grip tall, ACG-2, [K2.72022.0](#)



Handle Extension Block HEB-1 (without tape hook) [K2.0001016](#)



Handle Extension Block HEB-2 (with tape hock) [K2.72015.0](#)



ALEXA Handgrip Set K0.71033.0

### Cables

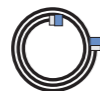

Cable LCS (5p) - LBUS (0.8m/2.6ft) - [K2.0007318](#)  
 ALEXA 12V Accessory Cable KC 154-SP-S, [K2.72031.0](#) (coiled)  
 ALEXA Ethernet Cable 3m KC 153-S, [K2.72021.0](#)  
 ALEXA EXT - EXT Cable 2m KC 155-S, K2.72032.0  
 ALEXA Ethernet-Ethernet Cable 2M KC 156-S, K2.72033.0  
 ALEXA Ethernet Remote Cable (1m/3.3ft) KC 158-S, K2.72041.0  
 ALEXA Ethernet Remote Cable (2m/6.6ft) KC 157-S, K2.72040.0

ALEXA Ethernet Extension Cable (15m/50ft) for RCU-4 KC 159-S, K2.72043.0 (up to three KC-159-S for total length of 47m/154ft with K2.72040.0 or 46m/151ft with K2.72041.0)

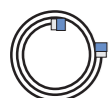

Power Cable  
 KC-20 K2.41966.0  
 KC-29 [K2.44693.0](#) (coiled)

### Power Supply & Battery Adapter



Battery Adapter Back Hi-Load BAB-HV V-mount for ALEXA LF [K2.0019453](#)



Battery Adapter Back Hi-Load BAB-HG Gold-Mount for ALEXA LF, [K2.0019456](#)



Hawk-Woods RP-CFA1 Battery Adapter [K2.0019383](#)



B-Mount Adapter ALEXA BMM-24-ALEX [K2.0038613](#)



ARRI Power Supply Light 24V [K2.0034493](#)



Camera Handgrip Right, [K2.45886.0](#)



Extension for Handgrip [K2.47136.0](#)



Leveling Block LB-1, [K2.72017.0](#)



Ultrasonic Distance Measure UDM-1 Set [K0.60055.0](#)  
 Cable UDM-ALEXA K2.65261.0



Ext Distribution Box EDB-1 K2.72038.0



ALEXA LF/ALEXA SXT W Case [K2.0015098](#)

## Configuration Overview | 1.4.0 / 2024.01

### AMIRA Camera Sets

#### AMIRA Camera Set Eco: [K0.0001090](#)

Features include HD 1080i & 1080p recording at 0.75 - 100 fps to QuickTime ProRes 422 LT or 422 files with Rec 709 encoding; 3 Looks with image parameters for knee, gamma, saturation & other adjustable in the camera, focus and exposure control tools; Intervalometer; Multicam interface; S16 lens mode.

#### AMIRA Camera Set with Advanced License: [K0.0001091](#)

Advanced license key provides HD 1080i & 1080p recording at 0.75 - 200 fps to QuickTime ProRes 422 LT, 422, or 422 HQ files with Rec 709 or Log C encoding; Complete CDL and video look functions; import looks without 3D LUT; focus and exposure control tools; dynamic auto tracking white balance; remote control; Bluetooth audio monitoring; Features additional to basic AMIRA set: 100 - 200 fps recording; ProRes 422 HQ codec; Log C encoding; more look functions including import/export and ASC CDL in-camera grading; dynamic auto tracking white balance; remote control; Bluetooth audio monitoring; pre-recording function.

#### AMIRA Camera Set with Premium License - All Included: [K0.0014798](#)

Premium license key provides HD 1080i & 1080p or 2K (2048 x 1152) recording at 0.75 - 200 fps to QuickTime ProRes 422 LT, 422, 422 HQ, or 4444 files with Rec 709 or Log C encoding; Complete CDL and video look functions; import looks with or without custom 3D LUTs; focus and exposure control tools; dynamic auto tracking white balance; remote control; Bluetooth audio monitoring; Pre-recording function; Intervalometer; Multicam interface; S16 lens mode. Features additional to Advanced AMIRA set: 2K (2048 x 1152) recording; ProRes 4444 codec, Support for Looks including a custom 3D LUT.

includes new:

10.0014641 1x ARRI AMIRA Look Library License

10.0003723 1x AMIRA UHD License Key

K2.75004.0 1x AMIRA Viewfinder MVF-1

K1.71700.0 1x AMIRA camera body, camera handle, viewfinder mount, viewfinder cables, USB stick

Note: CFast 2.0 cards, lens mount, battery adapter and camera base mount are not included need to be ordered separately or as part of an accessories bundle and/or lens mount bundle.

available in the ARRI license shop: [10.0003723](#) - 4K UHD support



### Mechanical Accessories



**Viewfinder Attachment Bracket VAB-1**, [K2.0001297](#)



**Viewfinder Adapter VFA-2**, [K2.0001222](#)



**Viewfinder Extension Bracket VEB-3**, [K2.74000.0](#)



**Shoulder Belt Adapters SBA-1**, [K2.0001223](#)



**Side Accessory Bracket SAB-2**, [K2.0014088](#)



**AMIRA Microphone Holder Bracket MHB-2**, [K2.75005.0](#)



**Heated Eycup, HE-7**  
K2.0003898



**GPB-1 Mounting Bracket**,  
K2.0008533  
(clamp console CLM-5/c-force  
K2.0006176 NOT incl.)



**Handgrip Set right**  
K0.0001249



**Rod Mounting Bracket RMB-4**, [K2.0013007](#)



**Camrade Raincover for AMIRA**, [K2.0004025](#)



**AMIRA Camera Case**, [K2.0001239](#)



**Accessories/ Camera Case**,  
[K2.0001241](#)



**AMIRA Camera Bag Portabrace**,  
[K2.0001240](#)

### AMIRA Camera Support



**Wedge Plate Adapter WPA-1**, [K2.75000.0](#)



**Bridge Plate Adapter BPA-3**, [K2.75006.0](#)  
(compatible with BP-8)



**Compact Bridge Plate CBP-3 19mm for AMIRA**,  
[K2.0019580](#)



**Compact Bridge Plate CBP-4 15mm for AMIRA**, [K2.0019582](#)



**BP-8, 19mm rods**  
[K2.47090.0](#)



**BP-9, 15mm rods**  
[K2.47091.0](#)



**Quick Release Plate QRP-1**, [K2.0000399](#)



**Universal Adapter Plate UAP-2 Set**, [K0.0001280](#)



**Universal Adapter Plate UAP-2**, [K2.0001221](#)

### AMIRA Power Option



**B-Mount Adapter BMM-AMIRA**  
[K2.0038614](#)



**Gold Mount Battery Adapter**  
[K2.75001.0](#)



**V-lock Battery Adapter**  
[K2.75002.0](#)



**Ambient Power slot for AMIRA (for Gold Mount AB batteries)**, [K2.0008762](#)



**Ambient Power slot for AMIRA (for V-lock batteries)**, [K2.0008763](#)



**ARRI Power Supply Light 24V**, [K2.0034493](#)

### Lens Mounts and Adapter



**ARRI LPL Mount (LBUS)**  
[K2.0018983](#)



**ARRI PL to LPL Adapter**  
[K2.0016936](#)



**Titanium PL LDS mount with LBUS connector**, [K2.0003216](#)  
LBUS connector not working on Amira



**PL LDS Lens Mount**  
[K2.0001107](#)



**B4 Lens Mount**  
[K2.0001237](#)



**EF Lens Mount**  
[K2.0001103](#)



**PL to B4 Lens Adapter**  
[K2.0001238](#)

### Cables

**AMIRA Power Cable Straight KC-50 (2m, 6.6 feet)**, [K2.75007.0](#)

**AMIRA Viewfinder Cable Short (0.5m, 1.64 feet)**, [K2.0007750](#)

**AMIRA Viewfinder Cable Medium (1m, 3,28 feet)**, [K2.0007751](#)

**AMIRA Viewfinder Cable Long (3m, 9,84 feet)**, [K2.0009003](#)

**AMIRA 12/20pin Hirose ENG Lense Cable Short (0.25m, 0.8 feet)**, [K2.0001268](#)



**AMIRA Audio XLR Cable**

**5pin Male to 5pin Female Short (0.4m, 1.3 feet)**, [K2.0001269](#)

**5pin Male to 3pin Female Short (0.4m, 1.3 feet)**, [K2.0001270](#)

**3pin Male to 3pin Female Short (0.4m, 1.3 feet)**, [K2.0001271](#)

### Electronic Accessories



**Camera Control Panel CCP-1 for ALEXA Mini**,  
K0.00010096  
(cable set and L-bracket incl.)



**General Purpose IO Box GPB-1**, [K2.0007642](#)  
(cable K2.000773)



**AMIRA Onboard Microphone Set**  
[K2.0004024](#)

### AMIRA Accessory Bundles

**Accessory Bundle 1: [K0.0001244](#)**

includes:

[K2.0001223](#) 1x Shoulder Belt Adapters  
[K2.0001240](#) 1x AMIRA Camera Bag Portabrace  
[K2.75005.0](#) 1x Micro. Holder Bracket MHB-2  
[K2.0024245](#) 1x Angelbird CFast 2.0 Card Reader  
[K2.0015640](#) 2x SanDisk CFast2.0 card 256GB  
[K2.75000.0](#) 1x Wedge Plate Adapter WPA-1

**Accessory Bundle 2: [K0.0001245](#)**

Includes:

[K2.75000.0](#) 1x Wedge Plate Adapter WPA-1  
[K2.0016648](#) 2x SanDisk CFast2.0 card 512GB  
[K2.0024245](#) 1x Angelbird CFast 2.0 Card Reader  
[K2.75005.0](#) 1x Microphone Holder Bracket MHB-2  
[K2.0001223](#) 1x Shoulder Belt Adapters  
[K2.0000399](#) 1x QRP-1-Baseplate  
[K2.0001240](#) 1x AMIRA Camera Bag Portabrace

**Accessory Bundle 3: [K0.0001246](#)**

Includes:

[K2.75000.0](#) 1x Wedge Plate Adapter WPA-1  
[K2.75006.0](#) 1x Bridge Plate Adapter BPA-3  
[K2.0016648](#) 2x SanDisk CFast2.0 card 512GB  
[K2.0024245](#) 1x Angelbird CFast 2.0 Card Reader  
[K2.75005.0](#) 1x Microphone Holder Bracket MHB-2  
[K2.0001221](#) 1x Universal Adapter Plate UAP-2  
[K2.0001297](#) 1x Viewfinder Attachment Bracket VAB-1  
[K2.72007.0](#) 1x Center Camera Handle CCH-1  
[K2.0001222](#) 1x Viewfinder Adapter VFA-2  
[K2.0000399](#) 1x QRP-1-Baseplate  
[K2.0001239](#) 1x AMIRA Camera Case

**Lens Mount Bundle: K0.0001247**

Includes:

[K2.0001103](#) 1x EF lens mount  
[K2.0001237](#) 1x B4 Lens Mount  
[K2.0001107](#) 1x PL LDS Lens Mount

## Amira, License & Media

AMIRA Camera Set Eco: [K0.0001090](#)  
 AMIRA Camera Set Advanced: [K0.0001091](#)  
 AMIRA Camera Set Premium: [K0.0014798](#)

AMIRA UHD License Key  
[10.0003723](#)

ARRI AMIRA Look Library License  
[10.0014641](#)

Extended Warranty for AMIRA  
 10.0006375

For Recording Media please see Config 1.9.0

## Electronic Accessories



Camera Control Panel CCP-1 Set for AMIRA, [K0.0010097](#) (cable set and L-bracket incl.)



AMIRA Onboard Microphone Set, [K2.0004024](#)



General Purpose IO Box GPB-1, [K2.0007642](#) (cable K2.0007736 incl.)



GPB-1 Mounting Bracket, K2.0008533 (clamp console CLM-5/c-force K2.0006176 NOT incl.)

## Accessories



AMIRA Camera Case, [K2.0001239](#)



Camera and Accessories Case [K2.0001241](#)



AMIRA Camera Bag Portabrace, [K2.0001240](#)



AMIRA Raincover [K2.0004025](#)



AMIRA Power Cable Straight KC-50 (2m, 6.6 feet), [K2.75007.0](#)

## Amira Mechanical Accessories

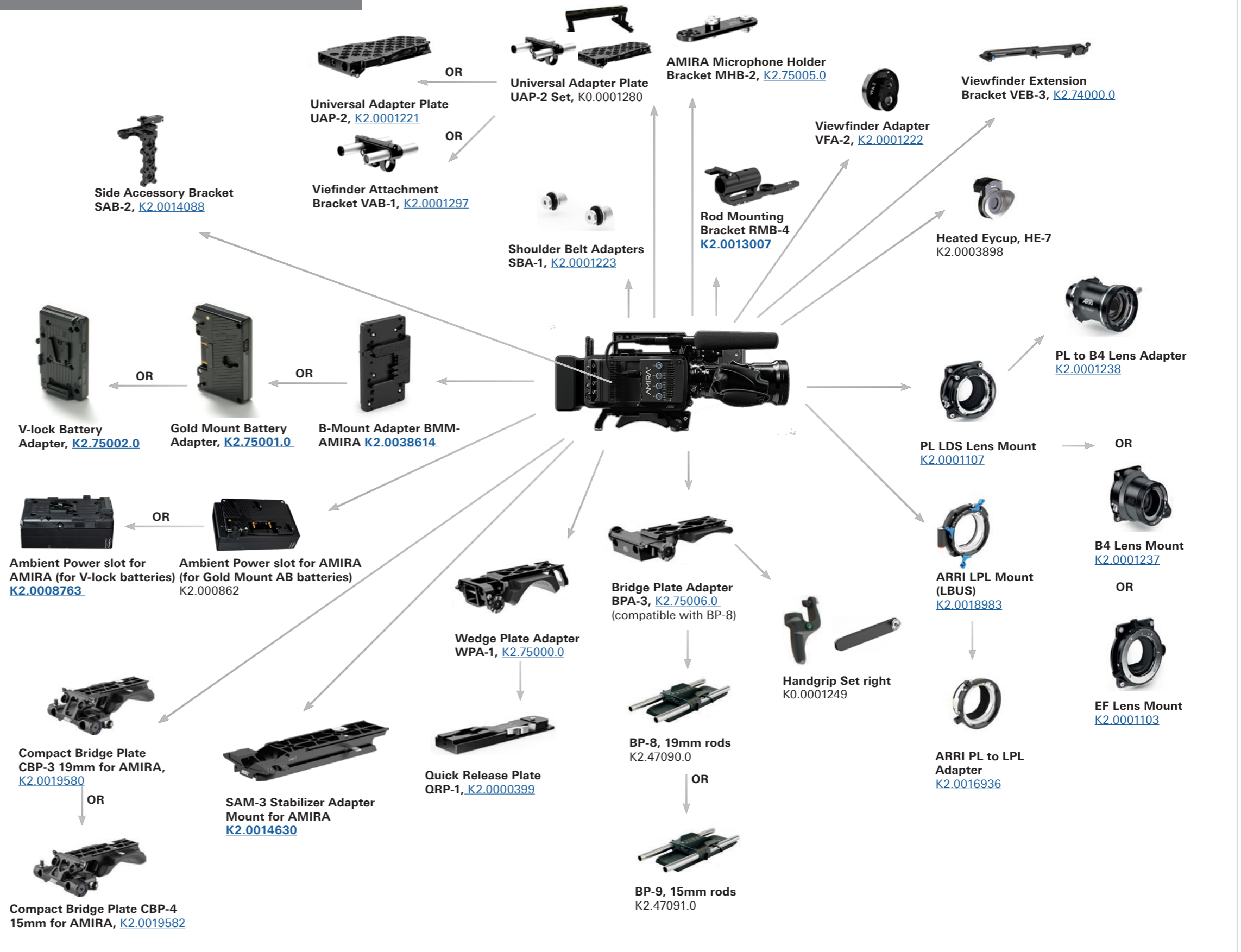

## Configuration Overview | 1.5.0 / 2024.07

### ALEXA Mini\*



#### ALEXA Mini Body, [K0.0014799\\*](#)

includes:  
K1.0003873 1x ALEXA Mini Body\*  
10.0014640 1x ALEXA Mini ARRI Look Library License Key

#### ALEXA Mini Body with 4:3 and ARRIRAW, [K0.0014797\\*](#)

includes:  
K1.0003873 1x ALEXA Mini Body\*  
10.0008148 1x ALEXA Mini ARRIRAW License Key  
10.0008147 1x ALEXA Mini 4:3 License Key  
10.0014640 1x ALEXA Mini ARRI Look Library License Key

#### ALEXA Mini ARRIRAW License Key

[10.0008148](#)

#### ALEXA Mini 4:3 License Key

[10.0008147](#)

#### ALEXA Mini ARRI Look Library License Key

10.0014640

#### Extended Warranty for ALEXA Mini

[10.0007223](#)

\* discontinued items  
no stock available  
anymore

### ALEXA Mini Viewfinder



ALEXA Mini Viewfinder  
MVF-1, [K2.0005861](#)  
(cable K2.0008135 0,75m incl.)



ALEXA Mini Viewfinder Cable 0.5m, [K2.0009367](#)  
ALEXA Mini Viewfinder Cable 0.75m, [K2.0008135](#)  
ALEXA Mini Viewfinder Cable 1.5m, [K2.0009169](#)

### Lens Mounts and Adapter



ARRI LPL Mount  
(LBUS)  
[K2.0018983](#)

ARRI PL-to-  
LPL Adapter  
[K2.0016936](#)

ARRI EF  
Mount  
(LBUS)  
[K2.0019965](#)

Titanium PL LDS  
mount with LBUS  
[K2.0003216](#)



PL LDS Lens  
Mount  
[K2.0001107](#)



B4 Lens  
Mount  
[K2.0001237](#)



EF Lens  
Mount  
[K2.0001103](#)



PL to B4 Lens  
Adapter  
[K2.0001238](#)

### ALEXA Mini Viewfinder



Camera Control Panel CCP-1  
for ALEXA Mini, K0.00010096  
(cable set and L-bracket incl.)



ALEXA Mini to CCP-1 cable set, K0.0010044  
ALEXA Mini to CCP-1 cable 0,5m (19"), K2.0009337  
ALEXA Mini to CCP-1 cable 1,0m (29"), K2.0009336  
ALEXA Mini to CCP-1 cable 1,5m (59"), K2.0009181

### Monitor



Transvideo Starlite  
HD5-ARRI 5" OLED Monitor [K2.0006960](#)



Starlite HD5 ARRI Ext cable angled, [K2.0008662](#)  
Starlite HD5 ARRI Ext cable straight, [K2.0008663](#)



Transvideo Starlite ARRI-WVS  
[K2.0015243](#)

### General Purpose IO Box



General Purpose IO Box  
GPB-1, [K2.0007642](#) (cable incl.)



GPB-1 Mounting Bracket,  
K2.0008533



Cable ALEXA Mini/AMIRA EXT to GPB-1,  
[K2.0007736](#)

### ALEXA Mini Media and Readers



For details regarding  
Recording Medias please see  
Configuration Overview 1.9.0

### EXT SYNC



EXT Distribution Box 2  
(EDB-2) for ALEXA Mini [K2.0013145](#)



ALEXA Mini EXT to EXT cable 1,5m (59 inch)  
[K2.0009051](#)

### Splitting Boxes and Adapter Plates



V-mount Power Splitting  
Box MkII, [K2.0014530](#)



V-Mount Adapter Plate Mk II  
for ALEXA Mini, [K2.0014531](#)



Gold Mount Power Splitting  
Box Mk II, [K2.0014532](#)



Gold Mount Adapter Plate  
Mk II for ALEXA Mini,  
[K2.0014533](#)



V-mount battery plate with  
hot-swap buffer, [K2.0015840](#)



Gold-mount battery plate with  
hot-swap buffer, [K2.0015859](#)

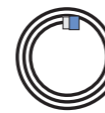

Power Cable Smart APU to ALEXA Mini  
6' (1.85m), K2.0015861  
Power Cable Smart APU to ALEXA Mini  
2.6' (0.80m), K2.0015862  
Power Cable Smart APU to ALEXA Mini  
(0.25m), K2.0015863

no pic available yet

Top support rod bracket 15mm LWS  
K2.0015865

### Cables & Power Supply

ARRI Power Supply Light 24V K2.0034493

Power Cable Straight KC-50 (2m, 6.6 feet), [K2.75007.0](#)

Ethernet Cable 3m KC 153-S, [K2.72021.0](#)

ALEXA Mini Audio connector with cable, [K2.0006171](#)

ALEXA Mini EXT to LCS, [K2.0007624](#)

ALEXA Mini EXT to EXT cable 1,5m (59 inch), [K2.0009051](#)

EXT-RS Adapter, [K2.0006170](#)

### Electronic Control System



cforce plus (Basic Set)  
[K0.0010103](#)



cforce mini (Basic Set)  
[K2.0006355](#)



Master Grip Left Wheel  
MLW-1, [K2.0009363](#)



Master Grip Right Rocker  
MRR-1, [K2.0009493](#)



Hi-5 SX Body Kit  
KK.0051704



Operator Control Unit OCU-1  
Basic Set, [K2.0020002](#)



Ultrasonic Distance  
Measure UDM-1 Set  
[K0.60055.0](#)



LCUBE CUB-1, [K0.0010104](#)  
LBUS cables need  
to be ordered separatley

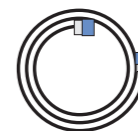

LBUS 0.2m/8", [K2.0006749](#)  
LBUS 0.3m/1ft, [K2.0006750](#)  
LBUS 0.5m/1.5ft, [K2.0006751](#)  
LBUS 0.8m/2.5ft, [K2.0006752](#)  
LBUS 1.5m/5ft, [K2.0006753](#)  
LBUS 3m/10ft, [K2.0006754](#)  
LBUS 6m/20ft, [K2.0006755](#)  
LBUS 15m/49ft, [K2.0006756](#)

Cable LBUS to D-Tap 1.2m/4ft, [K2.0006757](#)  
Cable LBUS to D-Tap 0.8m/2.5ft, [K2.0006758](#)  
Cable LBUS to RS 0.8m/2.5ft, [K2.0006759](#)  
Cable LBUS to XLR-4 0.8m/2.5ft, [K2.0006760](#)

## Configuration Overview | 1.5.1 / 2024.01

### ALEXA Mini



#### ALEXA Mini Body, [K0.0014799\\*](#)

includes:  
K1.0003873 1x ALEXA Mini Body\*  
10.0014640 1x ALEXA Mini ARRI Look Library License Key

#### ALEXA Mini Body with 4:3 and ARRIRAW, [K0.0014797\\*](#)

includes:  
K1.0003873 1x ALEXA Mini Body\*  
10.0008148 1x ALEXA Mini ARRIRAW License Key  
10.0008147 1x ALEXA Mini 4:3 License Key  
10.0014640 1x ALEXA Mini ARRI Look Library License Key

#### ALEXA Mini ARRIRAW License Key

10.0008148

#### ALEXA Mini 4:3 License Key

10.0008147

#### ALEXA Mini ARRI Look Library License Key

[10.0014640](#)

#### Extended Warranty for ALEXA Mini

10.0006955

### Accessories



#### Vertical Format Adapter Set for ALEXA Mini, [KK.0019829](#)

includes:  
K2.0019443 1x Vertical Viewfinder Adapter for ALEXA Mini  
K2.0019442 1x Vertical Format Adapter for ALEXA Mini



15 mm Reduction Insert  
[K2.66255.0](#)

LBS-2 Handgrip Set  
without on/off  
K0.0000465

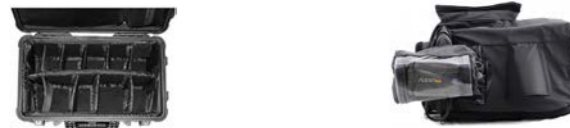

Camera and Accessory  
Case, [K2.0001241](#)

Wetsuit for ALEXA Mini,  
[K2.0010053](#)

### ALEXA Mini Mechanical Accessories

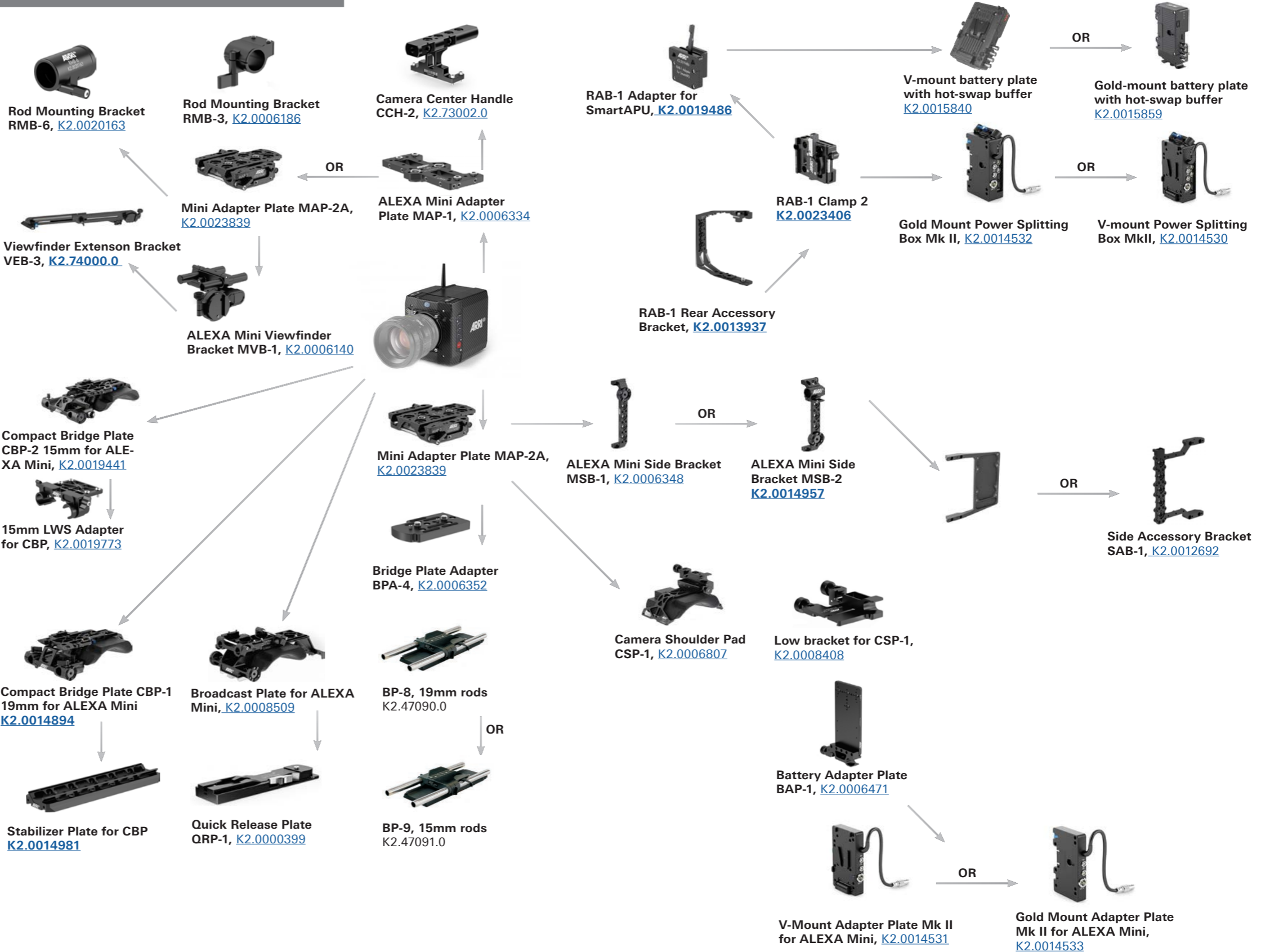

# Recording Media - CODEX Compact & Capture Drives



Configuration Overview | 1.6.0 / 2025.10

## CODEX Compact Drive



ALEXA 35



ALEXA Mini LF



**CODEX Compact Drive 2TB \*\*\***  
[K2.0023447](#)  
**CODEX Compact Drive set 3x2TB**  
[K0.0040251](#)  
**CODEX Compact Drive set 6x2TB**  
[KK.0040353](#)



**CODEX Compact Drive Express 1TB,**  
[K2.0053843](#)



**CODEX Compact Drive 1TB \*\***  
[K2.0024130](#)  
**CODEX Compact Drive set 3x1TB**  
[K0.0024596](#)  
**CODEX Compact Drive set 6x1TB**  
[KK.0024370](#)  
**CODEX Compact Drive set 12x1TB**  
[K0.0048298](#)



**CODEX Compact Drive Reader (USB-C)**  
[K2.0024134](#) (Codex# CDX.0001005)



**CODEX Compact Drive Dock (TB3)**  
[K2.0034320](#) (Codex# CDX.0001007)



**CODEX Compact Drive Adapter**  
[K2.0024131](#) (Codex# CDX.0001009)



**CODEX SXR Capture Drive Dock (TB3)**  
[K2.0019728](#) (CODEX# CDX-75013-2)

\*\* Most Compact Drive 1TB need a firmware update, which can be applied by ALEXA 35 in-camera. Updated drives will also be supported starting with Mini LF SUP 7.1.1.  
 \*\*\* Mini LF supports Compact Drive 2TB starting with Mini LF SUP 7.1.1

## CODEX Capture Drive



ALEXA LF



ALEXA SXT W



**CODEX SXR Capture Drive Adapter**  
[K2.0008429](#) (Codex# CDX-37097)



**CODEX SXR Capture Drive 1TB**  
[K2.0006942](#) (CODEX# CDX-37019/18)

**CODEX SXR Capture Drive set 4x1TB**  
[K0.0006946](#)



**CODEX SXR Capture Drive 2TB**  
[K2.0006157](#) (CODEX# CDX-37021/20)

**CODEX SXR Capture Drive set 4x2TB**  
[K0.0015012](#)



**CODEX SXR Capture Drive Dock (TB3)**  
[K2.0019728](#) (CODEX# CDX-75013-2)

# Recording Media - CFast 2.0 & SxS PRO+ Cards



Configuration Overview | 1.6.1 / 2025.10

## CFast 2.0 Cards



ALEXA Mini



Amira



ARRI Angelbird CFast2.0 card 256GB\*  
K2.0021432 (Angelbird# AVproAR256)



SanDisk CFast2.0 card 256GB  
K2.0015640



SanDisk CFast2.0 card 128GB  
K2.0003623



ARRI SanDisk CFast2.0 card 512GB  
K2.0016648

SanDisk CFast2.0 card set 3x128GB  
K0.0019005

ARRI SanDisk CFast2.0 card set 3x512GB  
K0.0019007



Angelbird CFast 2.0 Card Reader (USB-C)\*  
K2.0024245



\* Angelbird Products:

purchase and sales directly via  
sales@angelbird.com  
[www.angelbird.com](http://www.angelbird.com)  
no further distribution via ARRI

## SxS PRO+ Cards



ALEXA LF



ALEXA SXT W



CODEX SxS to SXR adapter  
K2.0006338 (CODEX# CDX-37098)



Sony SxS PRO+ card 256GB  
K2.0014951

Sony SxS PRO+ card set 3x256GB  
K0.0015004

Available from various resellers



Sony SBAC-UT100  
or other SxS card reader

### End of Support

The last version of SxS PRO+ cards (E-Series) unfortunately also is the final chapter for ARRI and SxS. With SxS PRO X, Sony introduced a new generation of these cards, which brought some technical requirements that cannot be met in our range of ALEXA cameras.

# ALEXA 35 Live - Feature Licenses



Configuration Overview | 2.0.1 / 2026.07

	pre-installed licenses for existing ALEXA 35 Live camera (KK.0051068, pre-2026)	Licences for individual purchase				
		Cine Plus	High Speed	ARRIRAW	Open Gate / Anamorphic	Pre-record
Permanent	pre-installed	10.0053849	10.0052056	10.0052061	10.0052065	10.0052069
Temporary - 1 Year	-	10.0052080	10.0052058	10.0052062	10.0052066	10.0052070
Temporary - 30 days	-	10.0052081	10.0052059	10.0052063	10.0052067	10.0052071
Temporary - 7 days	-	10.0052082	10.0052060	10.0052064	10.0052068	10.0052072
0.75 - 60 fps	✓					
ProRes Recording	✓					
Enhanced Sensitivity	✓					
ARRI Color Management (in-camera SDR & HDR DRTs)	✓					
Basic 16:9 & 2:1 Spherical Recording Formats	✓					
ARRI Look File (CDL & 3D LUTs)	✓					
60 - 120 fps (for selected formats)		✓	✓			
ARRIRAW		✓		✓		
Open Gate Recording Formats		✓			✓	
Anamorphic Recording Formats		✓			✓	
Anamorphic De-squeeze in Monitor Path		✓			✓	
Pre-recording		✓				✓
ARRI Textures	✓					
Look Library	✓					
Custom Color Management	✓					
Live painting	✓					
Multicam Looks	✓					
Multicam Textures	✓					
Remote Tally	✓					

# ALEXA 35 Live (Xtreme ready) - Feature Licenses



Configuration Overview | 2.0.2 / 2026.07

Please Note:

To enable the High Frame Rate Over SDI feature of your Xtreme Ready ALEXA 35 Live camera (2026 onwards) and upgrade it to an ALEXA 35 Live Xtreme, it is necessary to install the High Frame Rate Over SDI and the High Seed License (also included in the Cine Plus and Premium Licenses) together.

	pre-installed licenses for ALEXA 35 Live camera KK.0056171 (Xtreme ready)	Extend Your Pre-Installed Licenses with Additional Options Available in the Shop						
		High Frame Rate (SDI)	High Speed	ARRIRAW	Open Gate / Anamorphic	Pre-record	Cine Plus	Premium
Permanent	Cameras are shipped with these licenses pre-installed	10.0056159	10.0052056	10.0052061	10.0052065	10.0052069	10.0053849	10.0053851
Temporary - 1 Year		10.0056160	10.0052058	10.0052062	10.0052066	10.0052070	10.0052080	10.0053853
Temporary - 30 days		10.0056161	10.0052059	10.0052063	10.0052067	10.0052071	10.0052081	10.0053854
Temporary - 7 days		10.0056163	10.0052060	10.0052064	10.0052068	10.0052072	10.0052082	10.0053855
0.75 - 60 fps	✓ Base License							
ProRes Recording	✓ Base License							
Enhanced Sensitivity	✓ Base License							
ARRI Color Management (in-camera SDR & HDR DRTs)	✓ Base License							
Basic 16:9 & 2:1 Spherical Recording Formats	✓ Base License							
ARRI Look File (CDL & 3D LUTs)	✓ Base License							
ARRICORE Recording	✓ Base License							
Max 480fps HD output from SDI outputs 1 & 2		✓						
Max fps for all available codecs/recording formats			✓				✓	✓
ARRIRAW Recording				✓			✓	✓
Open Gate Recording Formats					✓		✓	✓
Anamorphic Recording Formats					✓		✓	✓
Anamorphic De-squeeze in Monitor Path					✓		✓	✓
Pre-recording						✓	✓	✓
ARRI Textures	✓ Look License							✓
Look Library	✓ Look License							✓
Custom Color Management	✓ Look License							✓
Live painting	✓ Multicam License							
Multicam Looks	✓ Multicam License							
Multicam Textures	✓ Multicam License							
Remote Tally	✓ Multicam License							

# ALEXA 35 Live Xtreme - Feature Licenses



Configuration Overview | 2.0.3 / 2026.07

	ALEXA 35 Live Xtreme		ARRIRAW	Open Gate / Anamorphic	Pre-record	Cine Plus	Premium
Permanent	Cameras are shipped with these licenses pre-installed		10.0052061	10.0052065	10.0052069	10.0053849	10.0053851
Temporary - 1 Year			10.0052062	10.0052066	10.0052070	10.0052080	10.0053853
Temporary - 30 days			10.0052063	10.0052067	10.0052071	10.0052081	10.0053854
Temporary - 7 days			10.0052064	10.0052068	10.0052072	10.0052082	10.0053855
0.75 - 60 fps	✓	Base License					
ProRes Recording	✓	Base License					
Enhanced Sensitivity	✓	Base License					
ARRI Color Management (in-camera SDR & HDR DRTs)	✓	Base License					
Basic 16:9 & 2:1 Spherical Recording Formats	✓	Base License					
ARRI Look File (CDL & 3D LUTs)	✓	Base License					
ARRICORE Recording	✓	Base License					
Max 480fps HD output from SDI outputs 1 & 2	✓	HFR SDI & High Speed					
Max fps for all available codecs/recording formats	✓	HFR SDI & High Speed				✓	✓
ARRIRAW Recording			✓			✓	✓
Open Gate Recording Formats				✓		✓	✓
Anamorphic Recording Formats				✓		✓	✓
Anamorphic De-squeeze in Monitor Path				✓		✓	✓
Pre-recording					✓	✓	✓
ARRI Textures	✓	Look License					✓
Look Library	✓	Look License					✓
Custom Color Management	✓	Look License					✓
Live painting	✓	Multicam License					
Multicam Looks	✓	Multicam License					
Multicam Textures	✓	Multicam License					
Remote Tally	✓	Multicam License					

Controls	
<b>CALL</b>	Signals camera operator wants to talk
<b>PROD</b>	Volume of production intercom
<b>ENG</b>	Volume of engineering intercom
<b>PMG</b>	Volume of program audio on intercom
<b>TRACKER</b>	Volume of tracker intercom
<b>PRD</b>	Enables intercom production channel microphone
<b>ENG</b>	Enables intercom engineering channel microphone
<b>REL</b>	Push release button to make a change with A OUT button
<b>A OUT</b>	Switches between AES or analog line level for A OUT when REL is pushed

Controls	
<b>REL</b>	Push release button to make a change with A1 IN button
<b>A1 IN</b>	Switches between MIC 48V/MIC/LINE/AES for A1 IN when REL is pushed
<b>REL</b>	Unlocks (releases) the A2 IN button
<b>A2 IN</b>	Switches between MIC 48V/MIC/LINE/AES for A2 IN once unlocked
<b>SEL</b>	Selects one of the four return in channels for allocation to RET2 button
<b>RT2</b>	Switches from PGM video to the selected return in channel
<b>SEL</b>	Selects one of the four return in channels for allocation to RET1 button
<b>RT1</b>	Switches from PGM video to the selected return in channel



# ALEXA 35 Live - Multicam System - LPS-1 Fiber Camera Adapter - Connectors



Configuration Overview | 2.1.1 / 2024.05

Connectors	
<b>HEADSET</b>	XLR 5-pin socket for intercom headset
<b>A OUT</b>	XLR 3-pin plug for AES or analog line audio out
<b>A1 IN</b>	XLR 3-pin socket for audio input 1 (MIC 48V/MIC/LINE/AES)
<b>A2 IN</b>	XLR 3-pin socket for audio input 2 (MIC 48V/MIC/LINE/AES)
<b>FIBER</b>	Lemo 3K SMPTE 311M fiber connector (socket)
<b>AUX FIBER</b>	Neutrik Opticon connector for auxiliary fiber tunnel
<b>12V/4A</b>	Lemo EGG socket for 12V accessory power output*
<b>12V/2A</b>	Lemo EGG socket for 12V accessory power output
<b>12V/2A</b>	Lemo EGG socket for 12V accessory power output
<b>24V/4A</b>	ARRI RS Lemo socket for 24V accessory power output*

Connectors	
<b>GPIO</b>	Hirose 10-pin HR10A connector
<b>TRACKER</b>	Hirose 20-pin HR10A connector
<b>SDI1 OUT</b>	BNC Monitor out (= ALEXA 35 SDI 1 out)
<b>RET OUT</b>	BNC Monitor output of return video in from Fiber Base Station
<b>RCP PoE</b>	RJ45 Ethernet for direct RCP connection
<b>ETH</b>	RJ45 for auxiliary 1 Gbit/s Ethernet tunnel
<b>LLA PoE</b>	RJ45 Ethernet for Large Lens Adapter interface module for future use
<b>REF OUT</b>	BNC Genlock out
<b>AUX</b>	BNC Auxiliary/Teleprompter SDI out



# ALEXA 35 Live - Multicam System - LPS-1 Fiber base station



Configuration Overview | 2.1.2 / 2024.07

Connectors	(backside)
PSU 1	IEC 320 Universal AC mains power input (100 – 240V, 50/60Hz)
PSU 2	IEC 320 Universal AC mains power input (100 – 240V, 50/60Hz)
AUX FIBER	Neutrik Opticon connector for auxiliary fiber tunnel
CAMERA	Lemo 3K SMPTE 311M fiber connector (plug)
AUX TP IN	BNC input auxiliary/teleprompter (SDI up to 12G)
MON	BNC output with status overlay (SDI up to 3G)
HD OUT 1/2	2x BNC outputs for down converted HD signal (SDI up to 3G), progressive or interlaced
3G-SDI OUT (1) 1-4	4x BNC outputs for 4x single link 3G or 1x quad link 12G
3G-SDI OUT (2) 1-4	4x BNC outputs for 4x single link 3G or 1x quad link 12G
12G-SDI	4x BNC outputs for up to 4x single link 12G or 2x dual link 6G
RETURN IN 1-4	4x BNC inputs for return video (up to 3G)
GPIO	D-sub 15-pin for general purpose I/O
INTERCOM/TALLY/PGM	D-sub 25-pin for Intercom audio in/out, PGM audio in and Tally control (SONY style connector and pin-assignments)
REF OUT	1x BNC output for active genlock (black burst or tri-level sync) derived from PTP or analog REF IN

Connectors	(backside)
TC IN	1x BNC input for linear timecode
REF LOOP	1x BNC loop output of genlock input signal (black burst or tri-level sync)
REF IN	1x BNC input for genlock signal (black burst or tri-level sync)
AUDIO1 OUT	XLR 3-pin plug (line level or AES) for balanced analog or digital audio
AUDIO2 OUT	XLR 3-pin plug (line level or AES) for balanced analog or digital audio
AUDIO1 IN	XLR 3-pin socket (line level or AES) for balanced analog or digital audio
AUDIO2 IN	XLR 3-pin socket (line level or AES) for balanced analog or digital audio
LBUS	Lemo 4-pin for factory service use only
ST2110/SFP28	SFP28 transceiver modules with LC fiber connector (up to 25G) for SMPTE 2110, primary or redundant
ST2110/SFP28	SFP28 transceiver modules with LC fiber connector (up to 25G) for SMPTE 2110, primary or redundant
ETH TUNNEL	RJ45 for auxiliary 1 Gbit/s Ethernet tunnel
MGM PORT 2	RJ45 for multicam web interface
RCP PoE	RJ45 for remote control panels (with power)
MGM PORT 1	RJ45 for multicam web interface

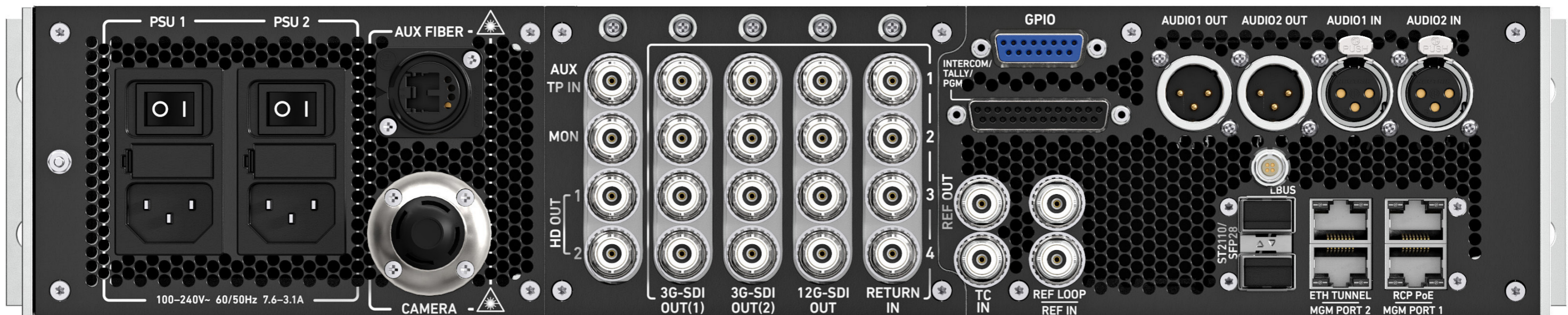

# ALEXA 35 Live - Multicam System - Sets Overview



Configuration Overview | 2.1.3 / 2026.07

## ALEXA 35 Live - Sets



**ALEXA 35 Live - Entry System, K0.0056174**  
includes:  
KK.0056171 1x ALEXA 35 Live Camera Body  
K2.0042652 1x ARRI PL Mount (Hirose)  
K2.0034180 1x Balance Utility Dovetail BUD-1  
K2.0051089 1x LPS-1 Fiber Camera Adapter FCA-1  
K2.0051088 1x LPS-1 Fiber Base Station FBS-1  
K2.0051067 1x Camera to FCA Ethernet Cable



**ALEXA 35 Live - Standard System, K0.0056176**  
includes:  
KK.0056171 1x ALEXA 35 Live Camera Body  
K2.0042652 1x ARRI PL Mount (Hirose)  
K2.0034180 1x Balance Utility Dovetail BUD-1  
K2.0051089 1x LPS-1 Fiber Camera Adapter FCA-1  
K2.0051088 1x LPS-1 Fiber Base Station FBS-1  
K2.0051067 1x Camera to FCA Ethernet Cable  
KK.0055173 1x ALEXA 35 Multicam Support Set 2



**ALEXA 35 Live - Pro System, K0.0056175**  
includes:  
KK.0056171 1x ALEXA 35 Live Camera Body  
K2.0042652 1x ARRI PL Mount (Hirose)  
K2.0034180 1x Balance Utility Dovetail BUD-1  
K2.0051089 1x LPS-1 Fiber Camera Adapter FCA-1  
K2.0051088 1x LPS-1 Fiber Base Station FBS-1  
K2.0051067 1x Camera to FCA Ethernet Cable  
KK.0055173 1x ALEXA 35 Multicam Support Set 2  
K2.0013042 1x Cable LBUS (angled) - LBUS (straight) (0.35m/1.15ft)  
K2.0050774 1x Large Lens Adapter LLA-1  
K2.0055339 1x LLA-1/BUD Slider Plate  
K2.0051099 1x LLA-1 Control Module  
K2.0050125 1x Cable Hirose to Box Lens  
K2.0050793 1x Case for LLA-1

## ALEXA 35 Live Xtreme - Sets



**ALEXA 35 Live Xtreme - Entry System, K0.0056964**  
(for HFR (high frame rate) video over SDI )  
includes:  
KK.0056613 1x ALEXA 35 Live Xtreme Camera Body  
K2.0042652 1x ARRI PL Mount (Hirose)  
K2.0034180 1x Balance Utility Dovetail BUD-1  
K2.0051089 1x LPS-1 Fiber Camera Adapter FCA-1  
K2.0051088 1x LPS-1 Fiber Base Station FBS-1  
K2.0051067 1x Camera to FCA Ethernet Cable



**ALEXA 35 Live Xtreme - Standard System K0.0056965**  
(for HFR (high frame rate) video over SDI )  
Includes:  
KK.0056613 1x ALEXA 35 Live Xtreme Camera Body  
K2.0042652 1x ARRI PL Mount (Hirose)  
K2.0034180 1x Balance Utility Dovetail BUD-1  
K2.0051089 1x LPS-1 Fiber Camera Adapter FCA-1  
K2.0051088 1x LPS-1 Fiber Base Station FBS-1  
K2.0051067 1x Camera to FCA Ethernet Cable  
KK.0055173 1x ALEXA 35 Multicam Support Set 2



**ALEXA 35 Live Xtreme - Pro System, K0.0056966**  
(for HFR (high frame rate) video over SDI )  
Includes:  
KK.0056613 1x ALEXA 35 Live Xtreme Camera Body  
K2.0042652 1x ARRI PL Mount (Hirose)  
K2.0034180 1x Balance Utility Dovetail BUD-1  
K2.0051089 1x LPS-1 Fiber Camera Adapter FCA-1  
K2.0051088 1x LPS-1 Fiber Base Station FBS-1  
K2.0051067 1x Camera to FCA Ethernet Cable  
KK.0055173 1x ALEXA 35 Multicam Support Set 2  
K2.0013042 1x Cable LBUS (angled) - LBUS (straight) (0.35m/1.15ft)  
K2.0050774 1x Large Lens Adapter LLA-1  
K2.0055339 1x LLA-1/BUD Slider Plate  
K2.0051099 1x LLA-1 Control Module  
K2.0050125 1x Cable Hirose to Box Lens  
K2.0050793 1x Case for LLA-1



## ALEXA 35 - Multicam Extension Sets

**For owners of existing ALEXA 35 cameras.  
PL Mount (Hirose) recommended.**

As long as the FCA is attached to any ALEXA 35 or ALEXA 35 Xtreme, it enables the Multicam license features in that camera. The ALEXA 35 or ALEXA 35 Xtreme then has all the features of the ALEXA 35 or ALEXA 35 Xtreme and of the ALEXA 35 Live. To use an ALEXA 35 or ALEXA 35 Xtreme in a multicam production without an FCA (for instance for ARTEMIS, TRINITY or Spidercam), a Multicam license has to be purchased. Each ALEXA 35 - Multicam Extension Set includes a 40% discount voucher for a Multicam license.



**ALEXA 35 - Multicam Extension Set Entry, K0.0051278**  
includes:  
KK.0051644 1x LPS-1 Fiber Camera Adapter FCA-1 4ExtSet  
(incl. discount code to purchase multicam license)  
K2.0051088 1x LPS-1 Fiber Base Station FBS-1  
K2.0051067 1x Camera to FCA Ethernet Cable



**ALEXA 35 - Multicam Extension Set Std., K0.0056227**  
includes:  
KK.0051644 1x LPS-1 Fiber Camera Adapter FCA-1 4ExtSet  
(incl. discount code to purchase multicam license)  
K2.0051088 1x LPS-1 Fiber Base Station FBS-1  
K2.0051067 1x Camera to FCA Ethernet Cable  
KK.0055173 1x ALEXA 35 Multicam Support Set 2



**ALEXA 35 - Multicam Extension Set Pro, K0.0056226**  
includes:  
KK.0051644 1x LPS-1 Fiber Camera Adapter FCA-1 4ExtSet  
(incl. discount code to purchase multicam license)  
K2.0051088 1x LPS-1 Fiber Base Station FBS-1  
K2.0051067 1x Camera to FCA Ethernet Cable  
KK.0055173 1x ALEXA 35 Multicam Support Set 2  
K2.0013042 1x Cable LBUS (angled) - LBUS (straight) (0.35m/1.15ft)  
K2.0050774 1x Large Lens Adapter LLA-1  
K2.0055339 1x LLA-1/BUD Slider Plate  
K2.0051099 1x LLA-1 Control Module  
K2.0050125 1x Cable Hirose to Box Lens  
K2.0050793 1x Case for LLA-1

## Configuration Overview | 2.0.2 / 2026.04

### ALEXA 35 Live - Multicam System Sets



**ALEXA 35 Live - Entry System (XR), K0.0056174**  
includes:  
KK.0056171 1x ALEXA 35 Live Camera Body (XR)  
K2.0042652 1x ARRI PL Mount (Hirose)  
K2.0034180 1x Balance Utility Dovetail BUD-1  
K2.0051089 1x LPS-1 Fiber Camera Adapter FCA-1  
K2.0051088 1x LPS-1 Fiber Base Station FBS-1  
K2.0051067 1x Camera to FCA Ethernet Cable



**ALEXA 35 Live - Standard System (XR), K0.0056176**  
includes:  
KK.0056171 1x ALEXA 35 Live Camera Body (XR)  
K2.0042652 1x ARRI PL Mount (Hirose)  
K2.0034180 1x Balance Utility Dovetail BUD-1  
K2.0051089 1x LPS-1 Fiber Camera Adapter FCA-1  
K2.0051088 1x LPS-1 Fiber Base Station FBS-1  
K2.0051067 1x Camera to FCA Ethernet Cable  
KK.0055173 1x ALEXA 35 Multicam Support Set 2



**ALEXA 35 Live - Pro System (XR), K0.0056175**  
includes:  
KK.0056171 1x ALEXA 35 Live Camera Body (XR)  
K2.0042652 1x ARRI PL Mount (Hirose)  
K2.0034180 1x Balance Utility Dovetail BUD-1  
K2.0051089 1x LPS-1 Fiber Camera Adapter FCA-1  
K2.0051088 1x LPS-1 Fiber Base Station FBS-1  
K2.0051067 1x Camera to FCA Ethernet Cable  
KK.0055173 1x ALEXA 35 Multicam Support Set 2  
K2.0013042 1x Cable LBUS (angled) - LBUS (straight) (0.35m/1.15ft)  
K2.0050774 1x Large Lens Adapter LLA-1  
K2.0055339 1x LLA-1/BUD Slider Plate  
K2.0051099 1x LLA-1 Control Module  
K2.0050125 1x Cable Hirose to Box Lens  
K2.0050793 1x Case for LLA-1

### ALEXA 35 - Multicam Extension Sets

**For owners of existing ALEXA 35 cameras. PL Mount (Hirose) recommended.**

As long as the FCA is attached to any ALEXA 35 or ALEXA 35 Xtreme, it enables the Multicam license features in that camera. The ALEXA 35 or ALEXA 35 Xtreme then has all the features of the ALEXA 35 or ALEXA 35 Xtreme and of the ALEXA 35 Live. To use an ALEXA 35 or ALEXA 35 Xtreme in a multicam production without an FCA (for instance for ARTEMIS, TRINITY or Spidercam), a Multicam license has to be purchased. Each ALEXA 35 - Multicam Extension Set includes a 40% discount voucher for a Multicam license.



**ALEXA 35 - Multicam Extension Set Entry, K0.0051278**  
includes:  
KK.0051644 1x LPS-1 Fiber Camera Adapter FCA-1 4ExtSet (enables Multicam licence-features)  
K2.0051088 1x LPS-1 Fiber Base Station FBS-1  
K2.0051067 1x Camera to FCA Ethernet Cable



**ALEXA 35 - Multicam Extension Set Std., K0.0056227**  
includes:  
KK.0051644 1x LPS-1 Fiber Camera Adapter FCA-1 4ExtSet  
K2.0051088 1x LPS-1 Fiber Base Station FBS-1  
K2.0051067 1x Camera to FCA Ethernet Cable  
KK.0055173 1x ALEXA 35 Multicam Support Set 2



**ALEXA 35 - Multicam Extension Set Pro, K0.0056226**  
includes:  
KK.0051644 1x LPS-1 Fiber Camera Adapter FCA-1 4ExtSet  
K2.0051088 1x LPS-1 Fiber Base Station FBS-1  
K2.0051067 1x Camera to FCA Ethernet Cable  
KK.0055173 1x ALEXA 35 Multicam Support Set 2  
K2.0013042 1x Cable LBUS (angled) - LBUS (straight) (0.35m/1.15ft)  
K2.0050774 1x Large Lens Adapter LLA-1  
K2.0055339 1x LLA-1/BUD Slider Plate  
K2.0051099 1x LLA-1 Control Module  
K2.0050125 1x Cable Hirose to Box Lens  
K2.0050793 1x Case for LLA-1



### Multicam Accessory Sets

**ALEXA 35 Multicam Support Set, KK.0051232**  
includes:  
K2.0049959 1x Touchdown Base Plate TBP-1  
K2.0049960 1x Touchdown Receiver Plate TRP-1  
K2.0050634 1x Live Production Handle LPH-1



**Operator Set, KK.0051696**  
includes:  
K2.0049425 1x Top Operator Grip TOG-1  
K2.0049422 1x Top Operator Plate TOP-1  
K2.0049959 1x Touchdown Base Plate TBP-1  
K2.0049960 1x Touchdown Receiver Plate TRP-1



**Large Lens Adapter LLA-1 Set Entry, KK.0056559**  
Inclusive:  
K2.0050774 1x Large Lens Adapter LLA-1  
K2.0055339 1x LLA-1/BUD Slider Plate  
K2.0050125 1x Cable Hirose to Box Lens



**ALEXA 35 Live RAB-4 V-Mount Set, KK.0055419**  
includes:  
K2.0055159 1x Rear Accessory Bracket RAB-4  
K2.0048324 1x NATO Rail Clamp NRC-2



**Large Lens Adapter LLA-1 Set Standard, KK.0056558**  
inclusive:  
K2.0050774 1x Large Lens Adapter LLA-1  
K2.0055339 1x LLA-1/BUD Slider Plate  
K2.0051099 1x LLA-1 Control Module  
K2.0013042 1x Cable LBUS (angled) - LBUS (straight) (0.35m/1.15ft)  
K2.0050125 1x Cable Hirose to Box Lens  
K2.0050817 1x camRade rainCover OB/EFP Large  
K2.0050793 1x Case for LLA-1



### Monitor Sets for Live Productions



**CCM-1 for Live Production Set, KK.0051229**  
includes:  
K2.0048523 1x CCM-1 with Foldable Sunhood, Screen Protector  
K2.0051078 1x Monitor Yoke Support MYS-1L (for CCM-1)  
K2.0023943 2x Cable VF (0.5m/1.5ft)  
K2.0001637 1x Cable RS - RS/PWR IN (0.5m/1.6ft)



**Live Production Monitor LPM-1 Basic Set, KK.0055403, includes:**  
K2.0055129 1x Live Production Monitor LPM-1 Unit  
K2.0054648 1x LPM-1 Short Foldable Sunhood  
K2.0054647 1x LPM-1 Front Handle

**Live Production Monitor LPM-1 Pro Set, KK.0054652**  
includes:  
KK.0055403 1x Live Production Monitor LPM-1 Basic Set  
K2.0054147 1x Monitor Yoke Support MYS-2 (for LPM-1)  
K2.0023943 1x Cable VF (0.5m/1.5ft)  
K2.0001637 1x Cable RS - RS/PWR IN (0.5m/1.6ft)

## Multicam Accessory Sets

### ALEXA 35 Multicam Support Set, [KK.0051232](#) \*

includes:  
 K2.0049959 1x Touchdown Base Plate TBP-1  
 K2.0049960 1x Touchdown Receiver Plate TRP-1  
 K2.0050634 1x Live Production Handle LPH-1



### ALEXA 35 Multicam Support Set 2, [KK.0055173](#)

includes:  
 K2.0049959 1x Touchdown Base Plate TBP-1  
 K2.0049960 1x Touchdown Receiver Plate TRP-1  
 K2.0049422 1x Top Operator Plate TOP-1  
 K2.0054985 1x Live Production Handle LPH-2



### Operator Set, [KK.0051696](#)

includes:  
 K2.0049425 1x Top Operator Grip TOG-1  
 K2.0049422 1x Top Operator Plate TOP-1  
 K2.0049959 1x Touchdown Base Plate TBP-1  
 K2.0049960 1x Touchdown Receiver Plate TRP-1



### Large Lens Adapter LLA-1 Set Entry, [KK.0056559](#)

Inclusive:  
 K2.0050774 1x Large Lens Adapter LLA-1  
 K2.0055339 1x LLA-1/BUD Slider Plate  
 K2.0050125 1x Cable Hirose to Box Lens



### ALEXA 35 Live RAB-4 V-Mount Set, [KK.0055419](#)

includes:  
 K2.0055159 1x Rear Accessory Bracket RAB-4  
 K2.0048324 1x NATO Rail Clamp NRC-2

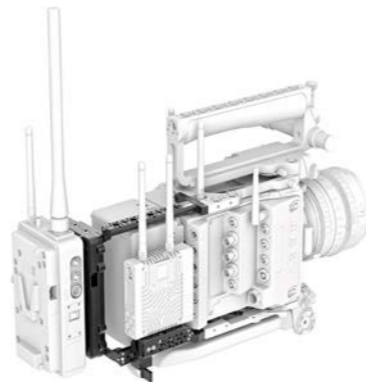

### Large Lens Adapter LLA-1 Set Standard, [KK.0056558](#)

inclusive:  
 K2.0050774 1x Large Lens Adapter LLA-1  
 K2.0055339 1x LLA-1/BUD Slider Plate  
 K2.0051099 1x LLA-1 Control Module  
 K2.0013042 1x Cable LBUS (angled) - LBUS (straight) (0.35m/1.15ft)  
 K2.0050125 1x Cable Hirose to Box Lens  
 K2.0050817 1x camRade rainCover OB/EFP Large  
 K2.0050793 1x Case for LLA-1



## Monitor and Viewfinder Sets for Live Productions

### CCM-1 for Live Production Set, [KK.0051229](#)

includes:  
 K2.0048523 1x CCM-1 with Foldable Sunhood, Screen Protector  
 K2.0051078 1x Monitor Yoke Support MYS-1L (for CCM-1)  
 K2.0023943 2x Cable VF (0.5m/1.5ft)  
 K2.0001637 1x Cable RS - RS/PWR IN (0.5m/1.6ft)



### MVF-2 Viewfinder Set, [K0.0042899](#)

includes:  
 K2.0020916 1x Multi Viewfinder MVF-2  
 K2.0042857 2x Cable VF Right Angle (0.5m/1.5ft)



### Viewfinder Mounting Set VMB-5, [KK.0034527](#)

includes:  
 K2.0033859 1x Viewfinder Mounting Bracket VMB-5  
 K2.0047906 1x Square Accessory Sleeve SAS-2



### Live Production Monitor LPM-1 Basic Set, [KK.0055403](#), includes:

K2.0055129 1x Live Production Monitor LPM-1 Unit  
 K2.0054648 1x LPM-1 Short Foldable Sunhood  
 K2.0054647 1x LPM-1 Front Handle



### Live Production Monitor LPM-1 Pro Set, [KK.0054652](#)

includes:  
 KK.0055403 1x Live Production Monitor LPM-1 Basic Set  
 K2.0054147 1x Monitor Yoke Support MYS-2 (for LPM-1)  
 K2.0023943 1x Cable VF (0.5m/1.5ft)  
 K2.0001637 1x Cable RS - RS/PWR IN (0.5m/1.6ft)



\* discontinued items  
 only as long as stock is available

# ALEXA 35 Live - Multicam System- Single Components



Configuration Overview | 2.1.5 / 2026.04

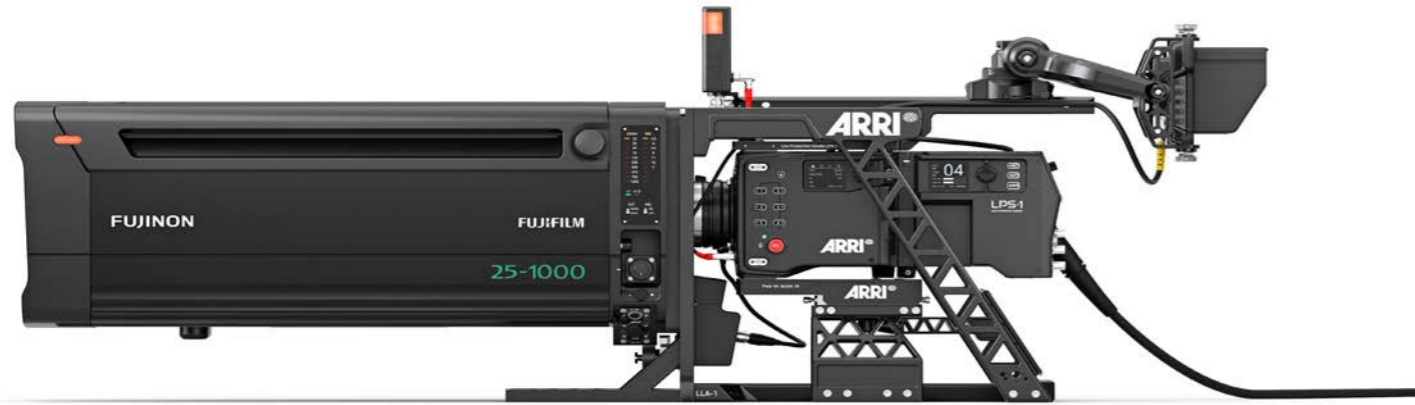

## Cables



Cable Hirose to Box Lens, [K2.0050125](#)



Camera to FCA Ethernet Cable, [K2.0051067](#)



Cable LENS/ENG (12p) - Hi (12p) analog [K2.0022328](#)



LPS-1 FBS Intercom/Tally/PGM Cable, K2.0051808

Cable LBUS (straight) to LBUS (straight) Length: 0.2m/8", [K2.0006749](#)  
 Cable LBUS (straight) to LBUS (straight) Length: 0.3m/1ft, [K2.0006750](#)  
 Cable LBUS (straight) to LBUS (straight) Length: 0.5m/1.5ft, [K2.0006751](#)  
 Cable LBUS (straight) to LBUS (straight) Length: 0.8m/2.5ft, [K2.0006752](#)  
 Cable LBUS (straight) to LBUS (straight) Length: 1.5m/5ft, [K2.0006753](#)  
 Cable LBUS (straight) to LBUS (straight) Length: 3m/10ft, [K2.0006754](#)  
 Cable LBUS (straight) to LBUS (straight) Length: 6m/20ft, [K2.0006755](#)  
 Cable LBUS (straight) to LBUS (straight) Length: 15m/49ft, [K2.0006756](#)  
 Cable LCS (5p) - LBUS (0.8m/2.6ft): [K2.0007318](#)

Cable LBUS (angled) to LBUS (straight) Length: 0.35m/1.1ft, [K2.0013042](#)  
 Cable LBUS (angled) to LBUS (straight) Length: 0.80m/2.3ft, [K2.0013043](#)  
 Cable LBUS (angled) to LBUS (straight) Length: 1m/3.3ft, [K2.0013041](#)  
 Cable LBUS (angled) to LBUS (angled) Length: 0.2m/8", [K2.0012785](#)  
 Cable LBUS (angled) to LBUS (angled) Length: 0.3m/1ft, [K2.0023823](#)  
 Cable LBUS (angled) to LBUS (angled) Length: 0.6m/2ft, [K2.0013040](#)  
 Cable LBUS (angled) to LBUS (angled) Length: 0.8m/2.6ft, [K2.0012630](#)

LBUS Star (0.2m/8in). K2.0023823

## ALEXA 35 Live - Multicam System - Components



LPS-1 Fiber Camera Adapter FCA-1, [K2.0051089](#)  
(only available in Sets)



LPS-1 Fiber Base Station FBS-1, [K2.0051088](#)  
(only available in Sets)



Skaarhoj RCP Pro ARRI V2B, [K2.0044481](#)



Tally Light Module TLM-1, [K2.0050656](#)  
LBUS cable needed



MVF-2 Viewfinder Set, [K0.0042899](#)



Live Production Monitor LPM-1 Pro Set, KK.0054652



RIA-1 Bracket [K2.0039465](#)



Viewfinder Mounting Bracket VMB-5, K2.0033859



Square Accessory Sleeve SAS-2, K2.0047906



Viewfinder Mounting Set VMB-5, [KK.0034527](#)



LLA-1 Control Module, K2.0051099



Top Operator Plate TOP-1, K2.0049422



Large Lens Adapter LLA-1, [K2.0050774](#)



LLA-1/BUD Slider Plate, K2.0055339



LLA-1 Plate for AMIRA [K2.0050775](#)



LLA-1 Plate for ALEXA Mini/LF, [K2.0050776](#)



Balance Utility Dovetail BUD-1, [K2.0034180](#)



Monitor Yoke Support MYS-1L (for CCM-1) [K2.0051078](#)



Touchdown Base Plate TBP-1, [K2.0049959](#)



Touchdown Receiver Plate TRP-1, [K2.0049960](#)



Live Production Handle LPH-1, [K2.0050634](#) \*



camRade rainCover OB/EPF Large, [K2.0050817](#)



Case for LLA-1, [K2.0050793](#)



LPS-1 Fiber Base Station & RCP Case, K2.0051794



ALEXA 35 Live & Accessories Case, K2.0051793



FBS to LC-TAC Adaptor K2.0053874



FBS to ST-TAC Adaptor K2.0053875



LC-TAC to FCA Adaptor K2.0053876



ST-TAC to FCA Adaptor K2.0053877



Shotgun Microphone Holder SMH-1, K2.0055061



Live Production Handle LPH-2, K2.0054985



Monitor Yoke Support MYS-2 (for LPM-1) K2.0054147



Rear Accessory Bracket RAB-4, K2.0055159



Top Soft Pad TSP-1, K2.0055229

\* only as long as stock is available

# ALEXA 35 Live - Multicam System - Setup Classical



Configuration Overview | 2.2.0 / 2024.05

## Multicam Setup

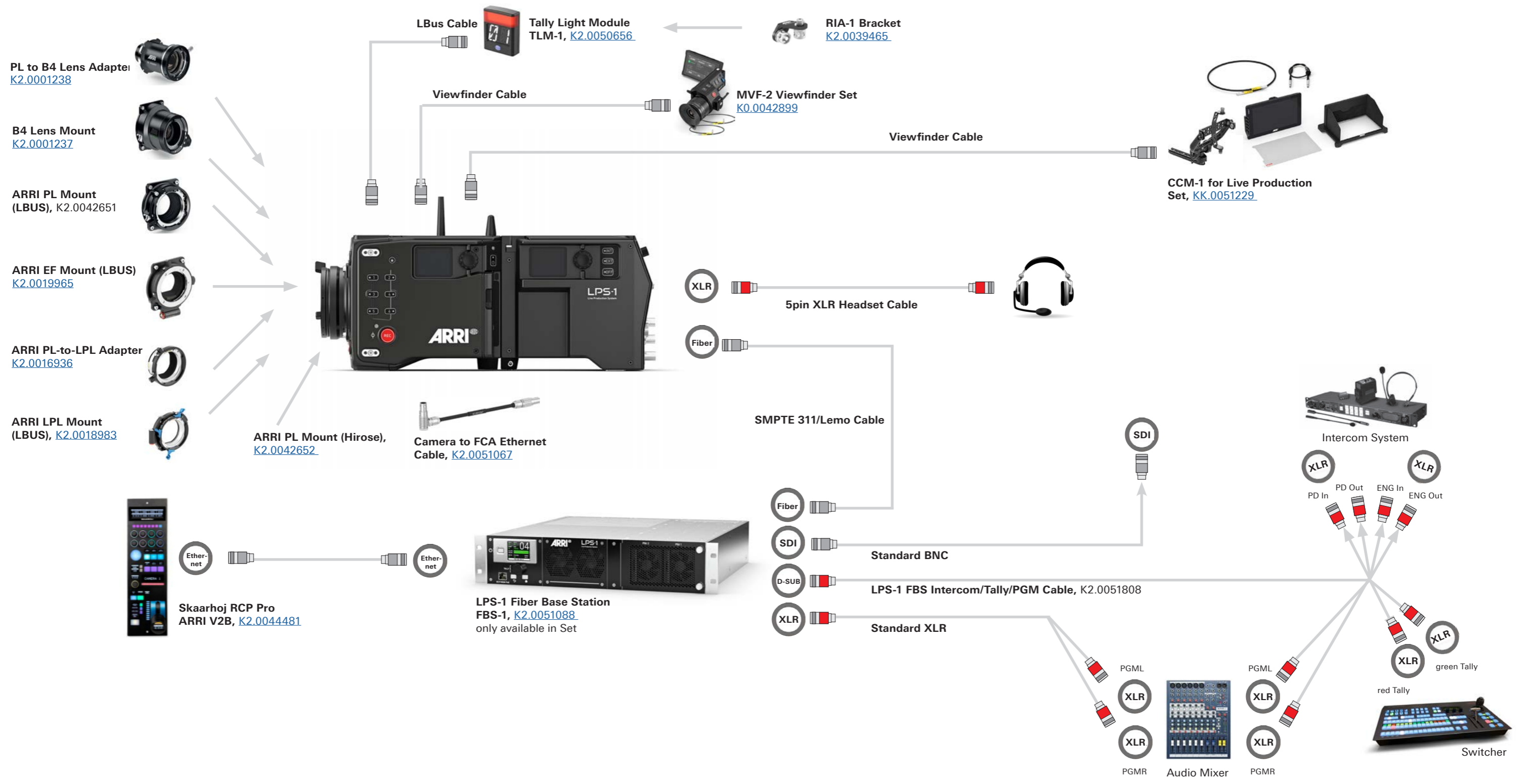

# ALEXA 35 Live - Multicam System - Setup Tactical Fiber



Configuration Overview | 2.2.1 / 2026.06

## Multicam Setup

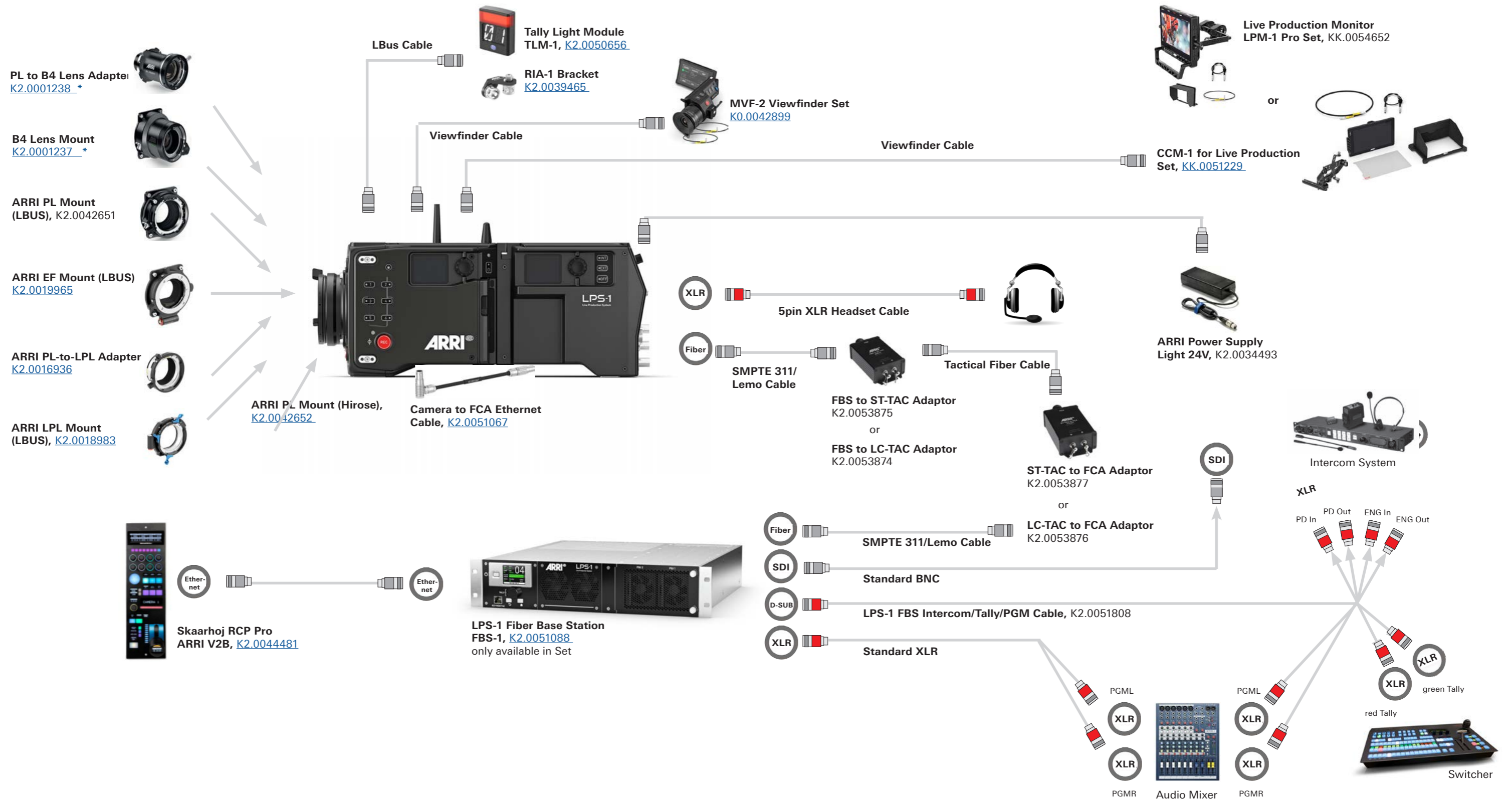

\* only as long as stock is available

# ALEXA 35 Live - Multicam System - Handheld Accessories Setup



Configuration Overview | 2.2.2 / 2026.06

## Handheld Accessories Setup

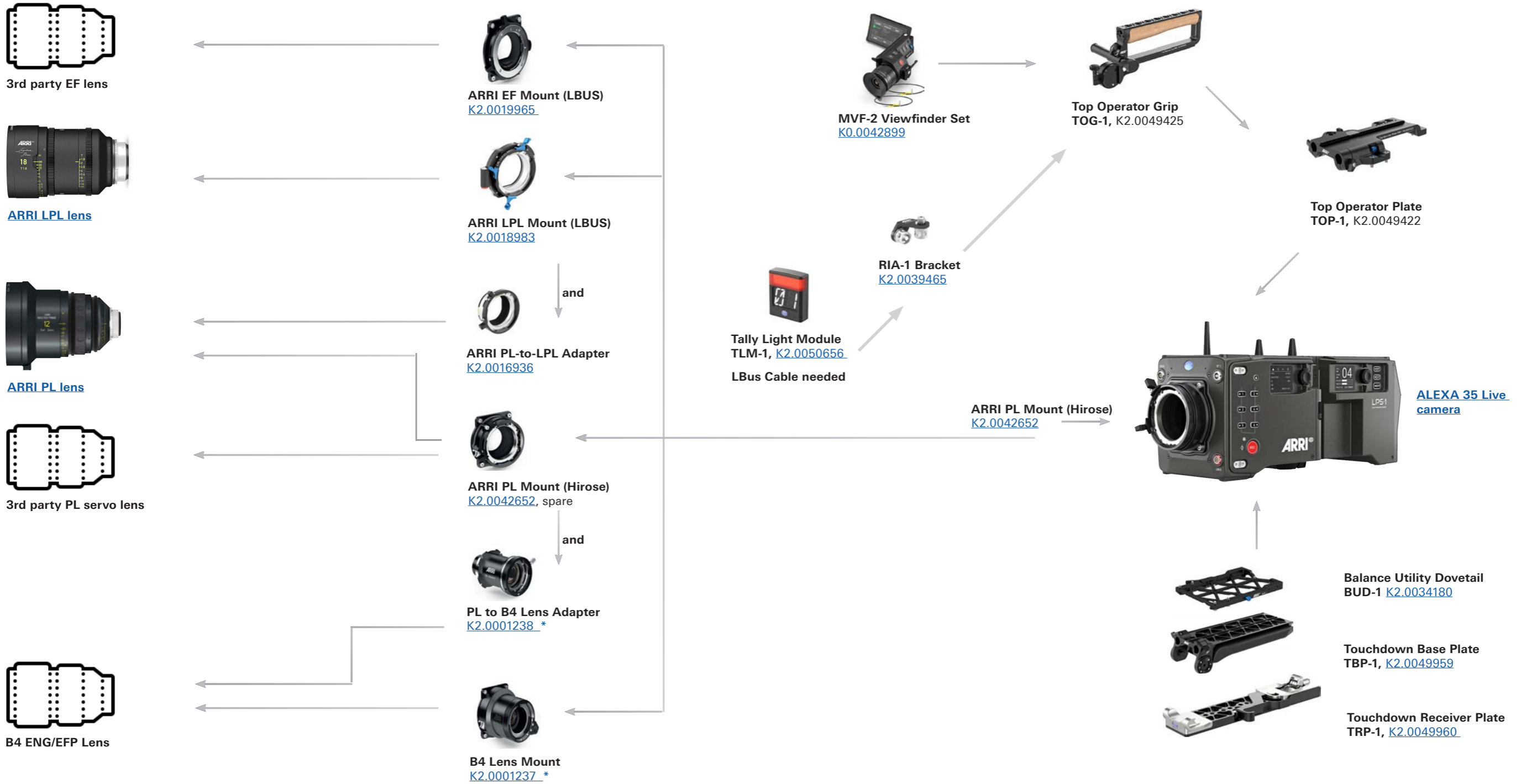

\* only as long as stock is available

# ALEXA 35 Live - Multicam System - Studio Accessories Setup



Configuration Overview | 2.2.3 / 2024.05

## Studio Accessories Setup

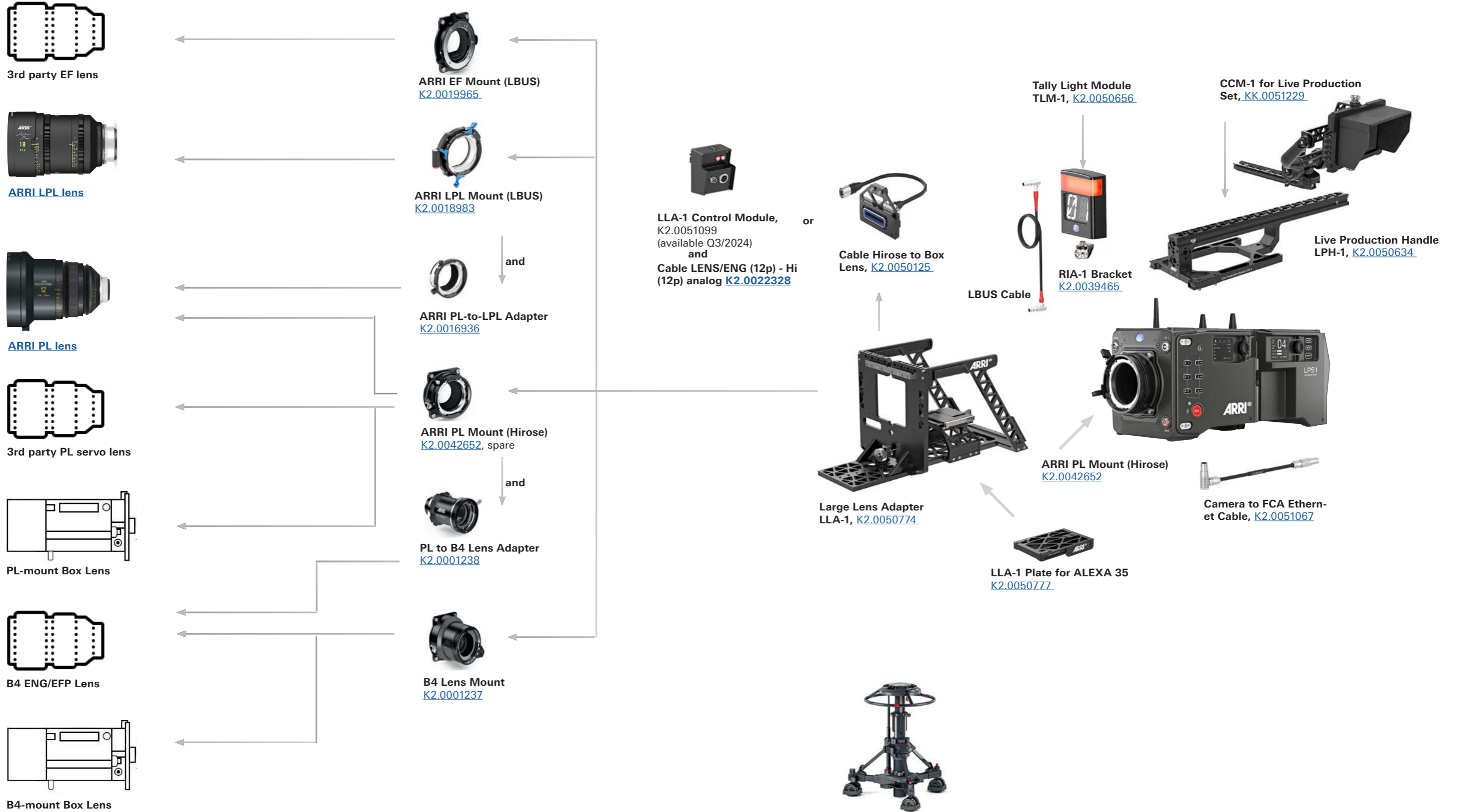

# ALEXA 35 Live - ECS Wireless Cine Application



Configuration Overview | 2.2.4 / 2025.09

## ALEXA 35 Live & cforce mini Motor Wireless Application



## ALEXA 35 Live - Iris control via RCP & Zoom and Focus control via Hand Units

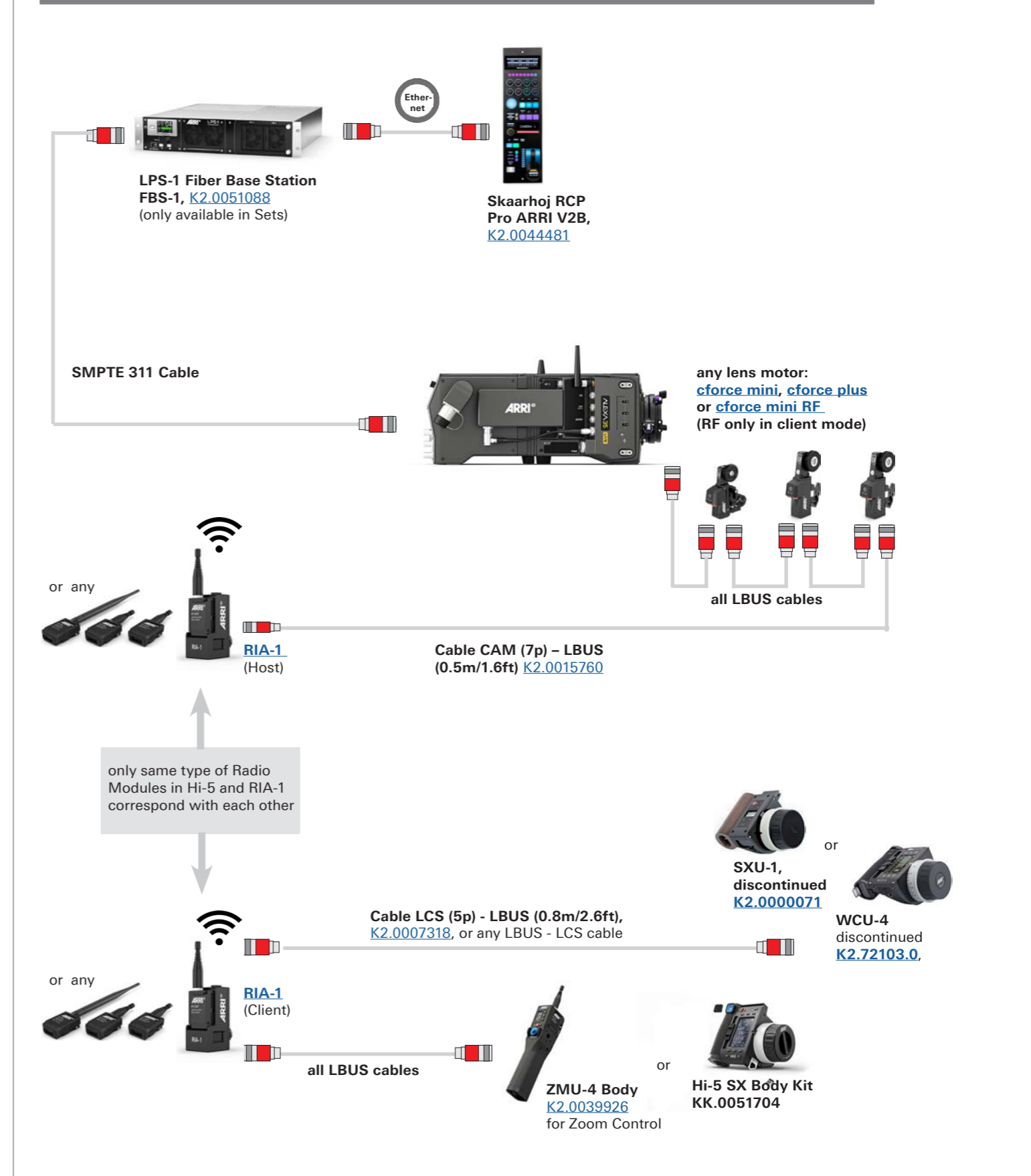

## ALEXA 35 Live & RIA-1 & OCU-1 or Master Grips and LBUS Control Units

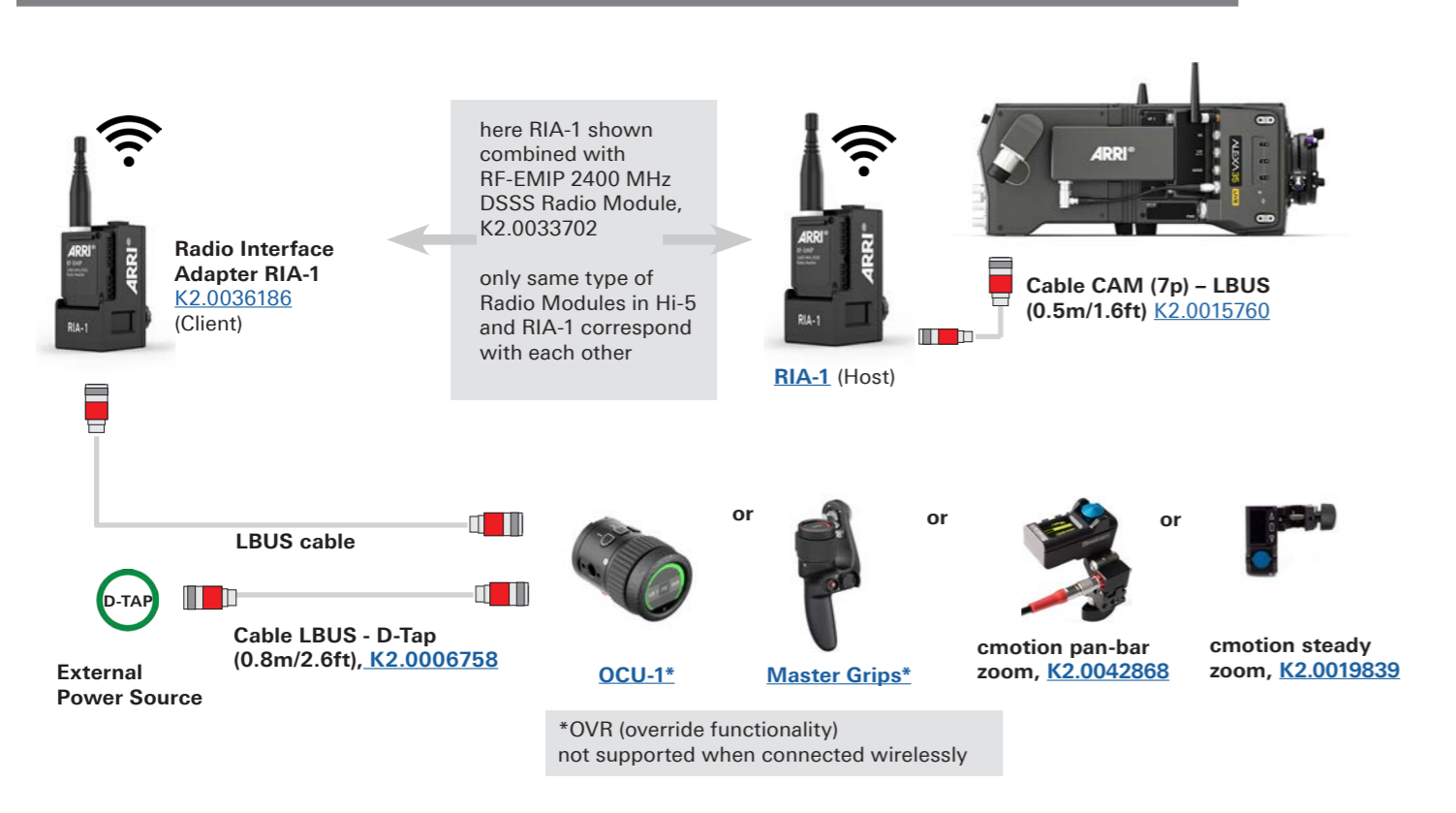

# ALEXA 35 Live - ECS Box Lens Application



Configuration Overview | 2.2.5 / 2025.04

## ALEXA 35 Live & Box Lenses - Wireless Zoom/Focus

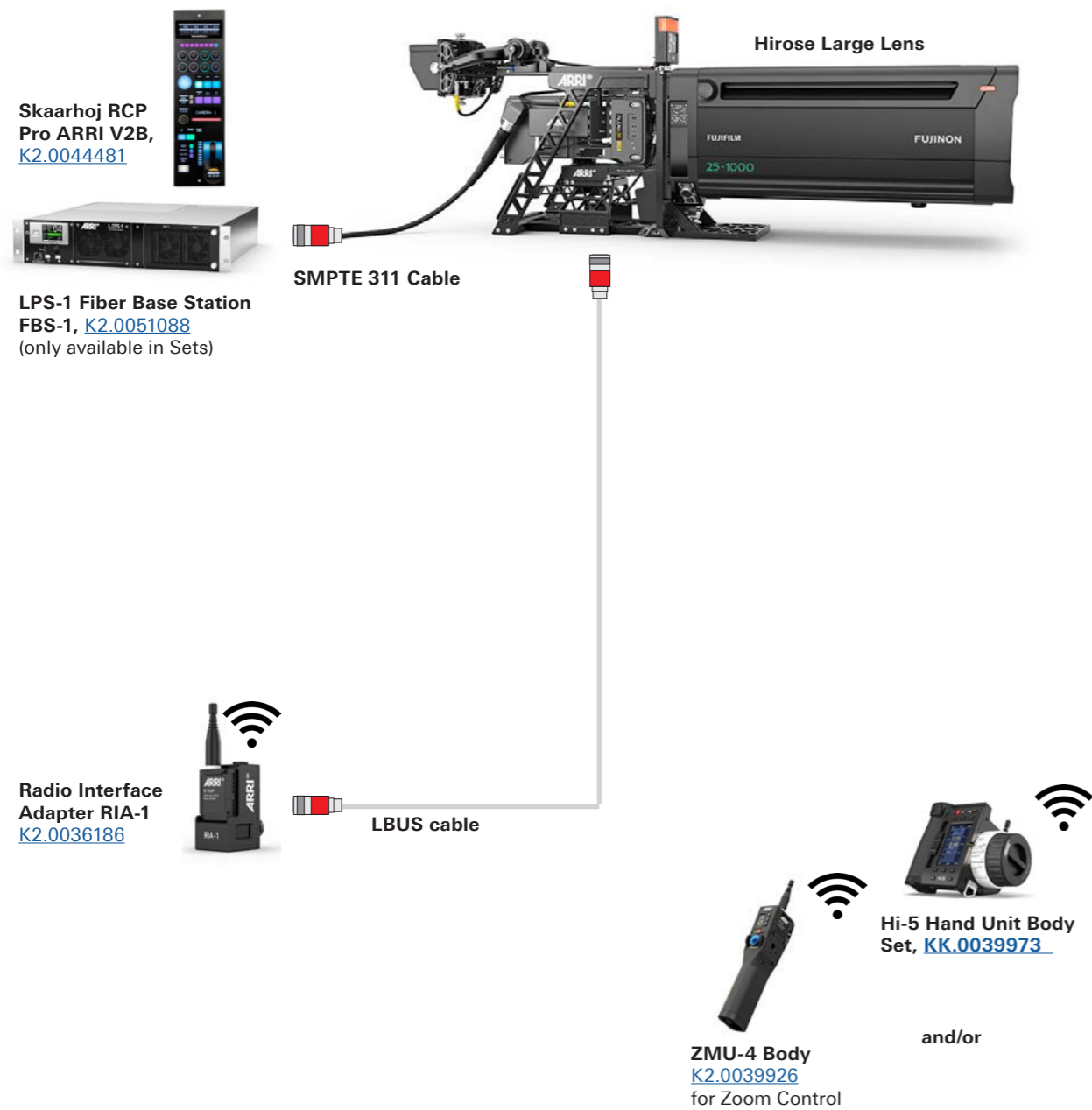

## ALEXA 35 Live & Box Lenses - Hard Wired

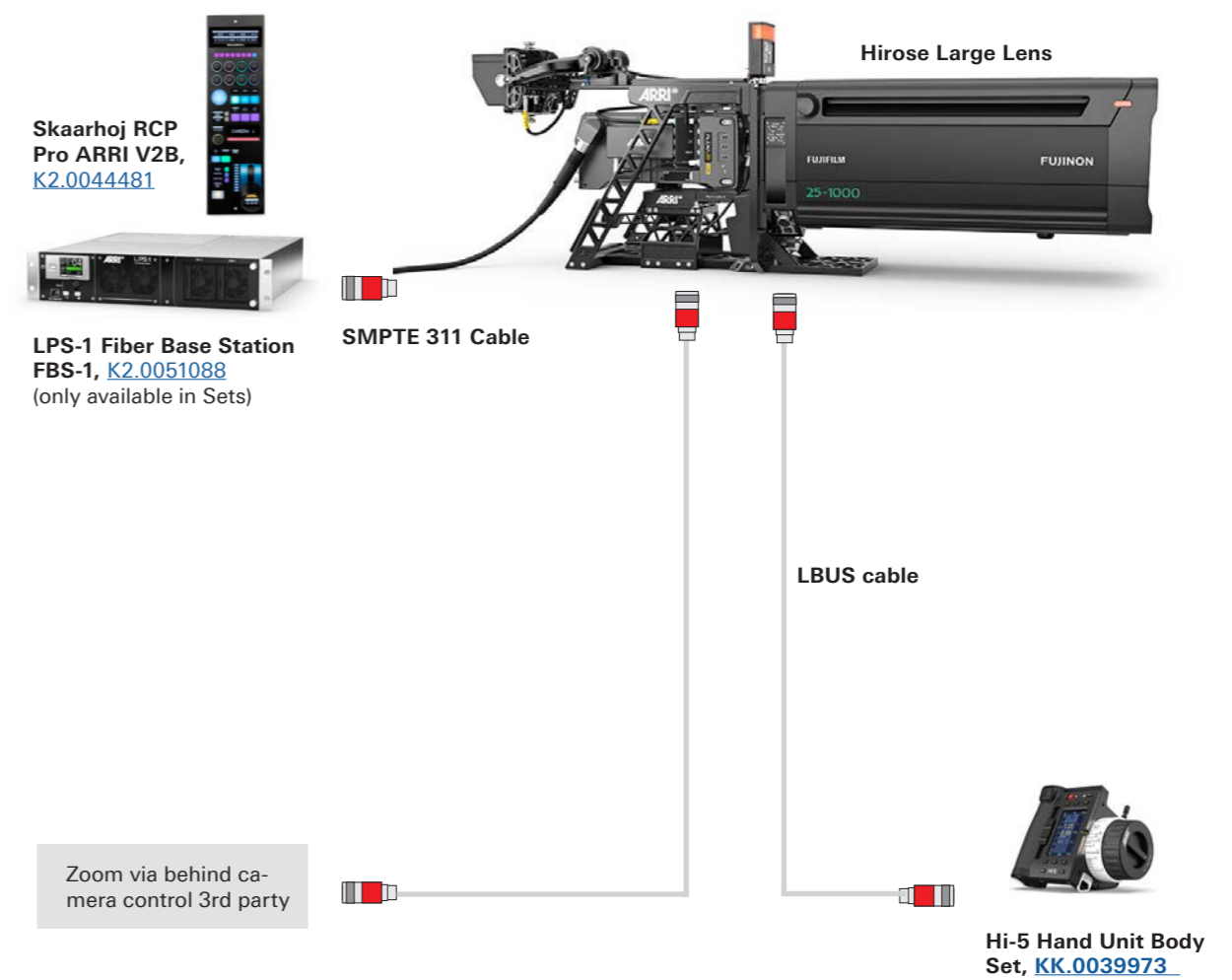

# ALEXA 35 Live - ECS General Control Application



Configuration Overview | 2.2.6 / 2025.04

## ALEXA 35 Live & Mastergrip - Servo Zoom Lens

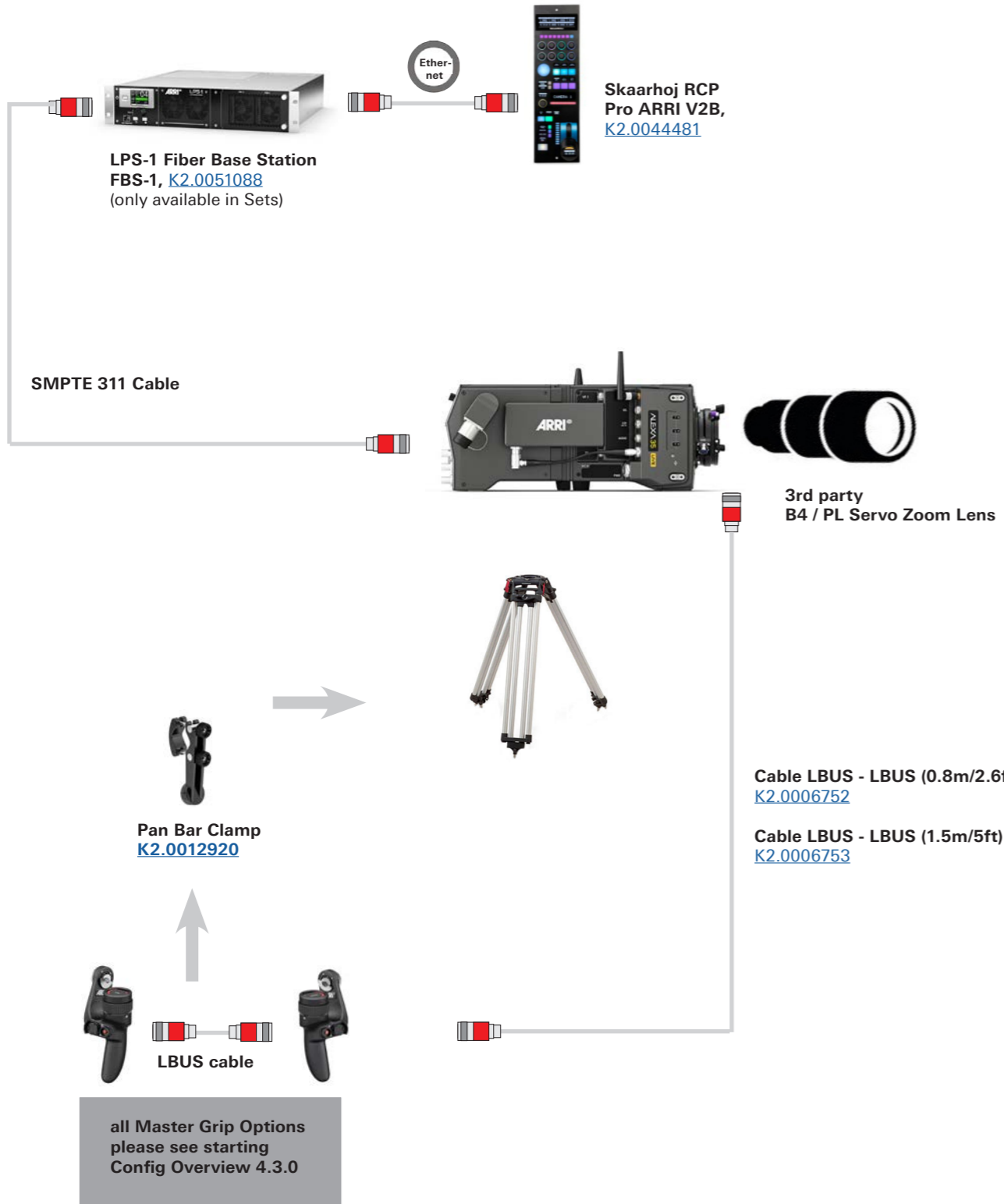

## ALEXA 35 Live & Mastergrip - Cine Lens

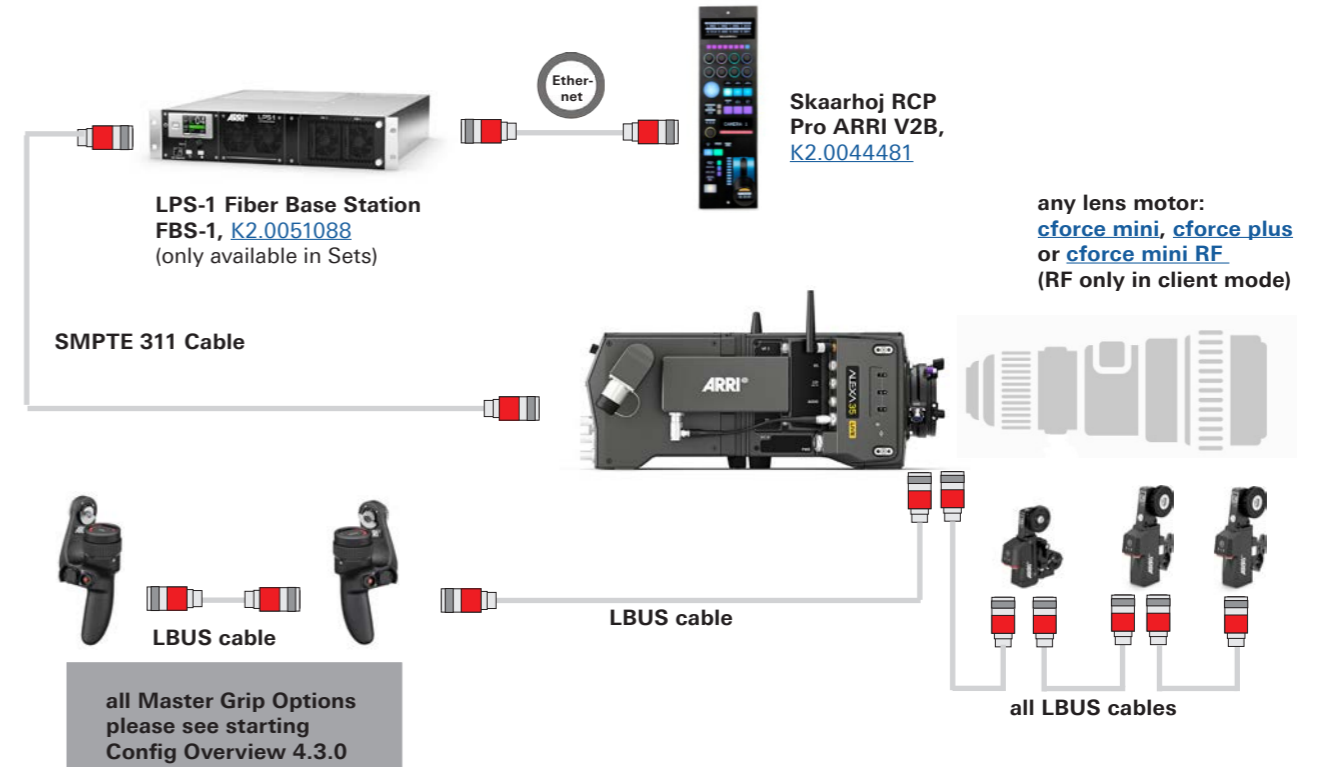

## ALEXA 35 Live & UDM-1



# AMIRA Live - Setup & Cable Configuration



Configuration Overview | 2.3.0 / 2023.11

## Multicam Setup

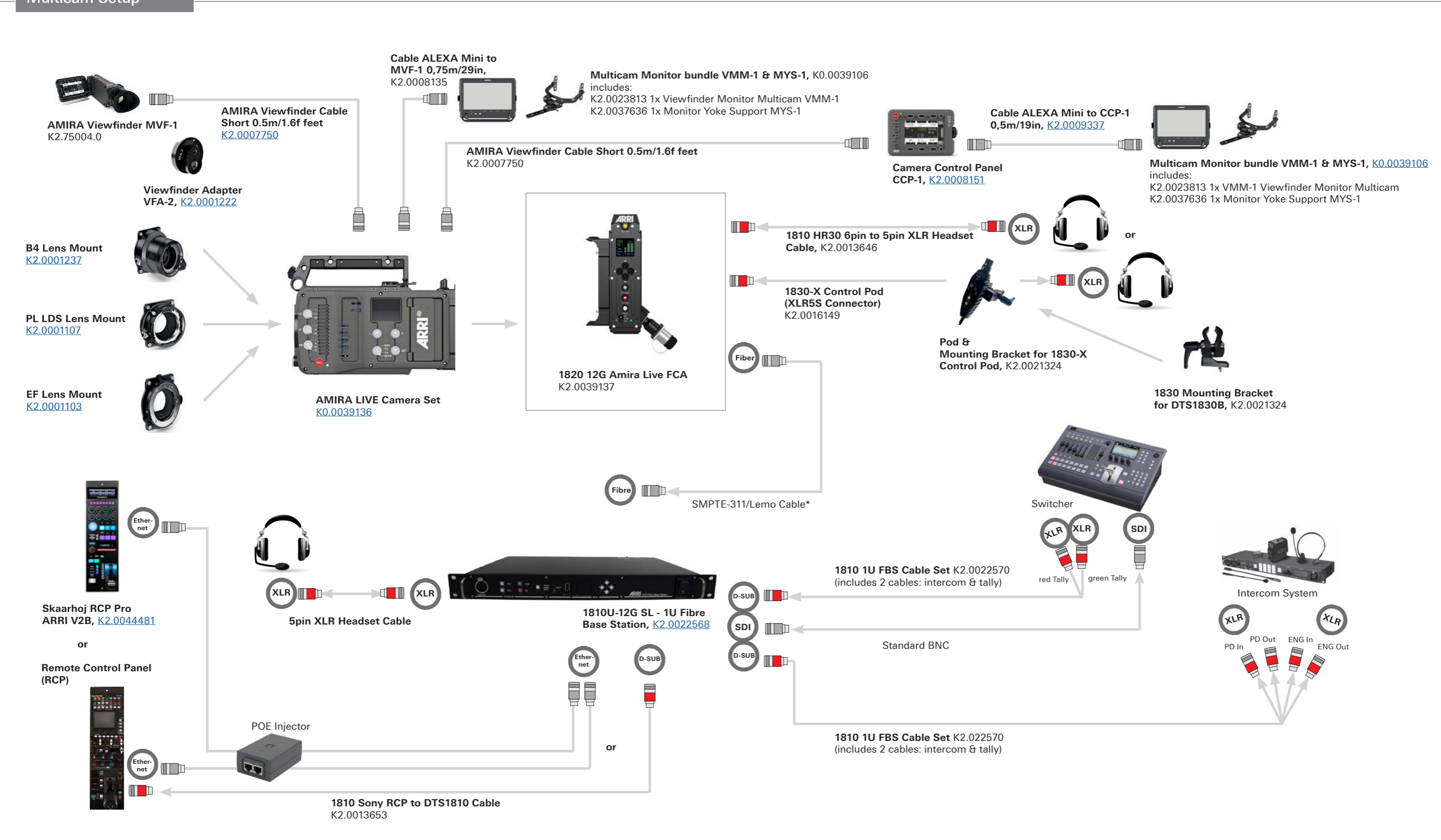

# AMIRA Live - Mechanical Accessories Setup



Configuration Overview | 2.3.1 / 2023.11

## Mechanical Accessories Setup

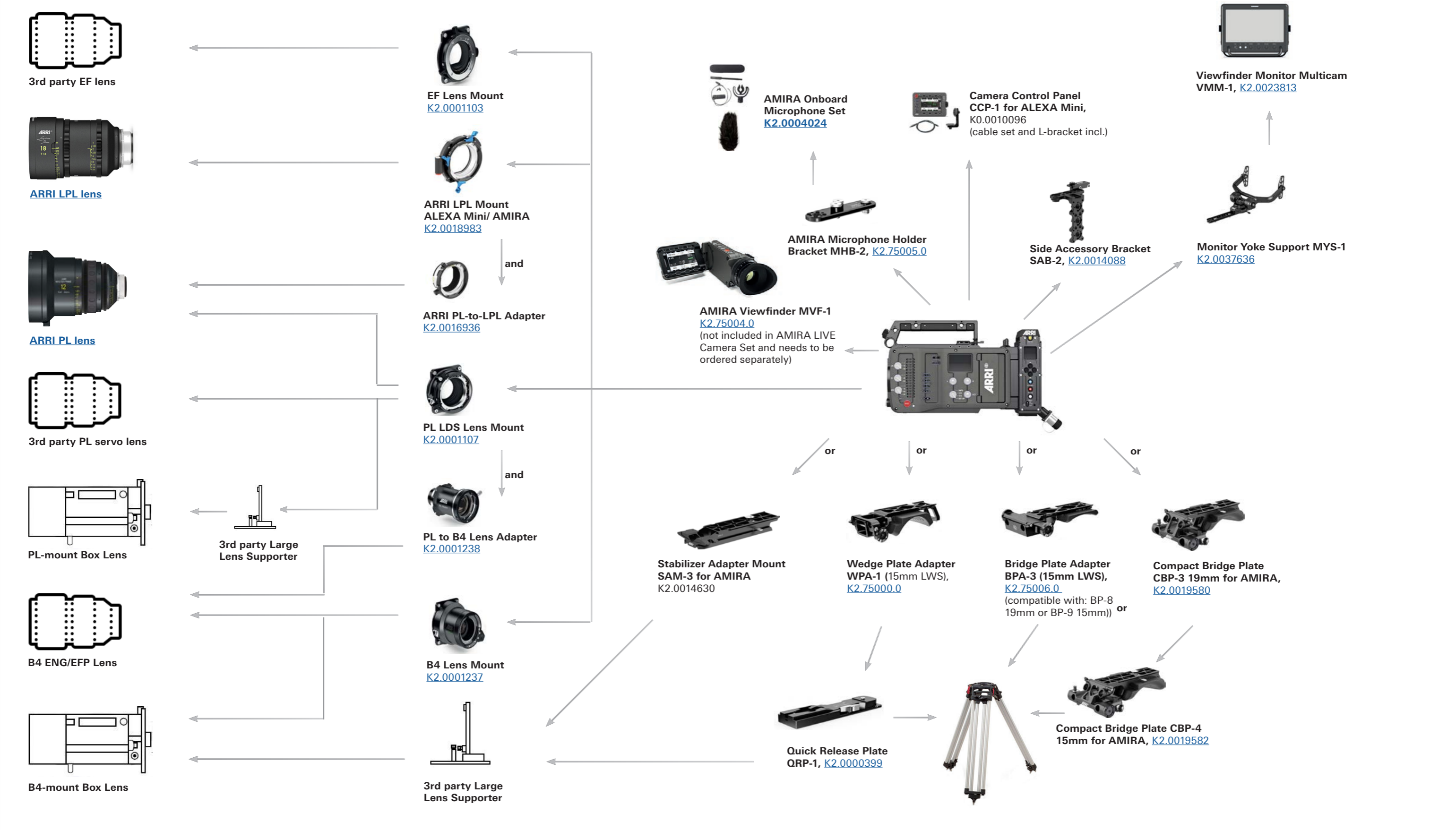

## AMIRA Live Sets



**AMIRA LIVE Camera Set, K0.0039136**  
includes:  
KK.0038511 1x AMIRA LIVE camera body (incl. CL kit K2.0023813)  
10.0001093 1x AMIRA Advanced License Key  
10.0003723 1x AMIRA 4K UHD License Key  
10.0014641 1x AMIRA ARRI Look Library License Key

Note: viewfinder & lensmount not included and need to be ordered separately



**AMIRA LIVE 1800 Camera Chain Set, K0.0039163**  
includes:  
K2.0039137 1x 1820 12G Amira Live FCA  
K2.0038531 1x 1800 AMIRA Live Frame Mount  
K2.0022568 1x 1810U-12G SL - 1U Fibre Base Station  
K2.0022570 1x 1810 1U FBS Cable Set  
K2.0016149 1x 1830-X Control Pod (XLR5S Connector)  
K2.0021324 1x Mounting Bracket for 1830-X Control Pod

**1820 12G Amira Live FCA, K2.0039137**



## 1800 Multicam Sets for ARRI Camera



for ALEXA Mini / Mini LF

for Amira



**1800 Set 1U FBS (4x3G&SL12G), K0.0022756**  
includes:  
K2.0013648 1x 1820-12G FCA Fibre CameraAdaptor 12G  
K2.0014813 1x 1820 FCA Lemo assembly  
K2.0014814 1x 1820 FCA Cable set for AMIRA  
K2.0014659 1x 1835 Dual Link 6G Video Input Option  
K2.0022568 1x 1810U-12G SL - 1U Fibre Base Station  
K2.0022570 1x 1810 1U FBS Cable Set

## Cable Set

**1820 FCA Cable set for ALEXA Mini/Mini LF, K2.0048472**  
includes:  
ALEXA MINI/LF-ETH 0,36m Cable  
ALEXA MINI/LF-GL 0,19m Cable  
ALEXA MINI/LF-SDI1 0,19m Cable  
ALEXA MINI/LF-SDI2 0,2m Cable  
ALEXA MINI/LF-Monitor 0,45m Cable



## Monitor

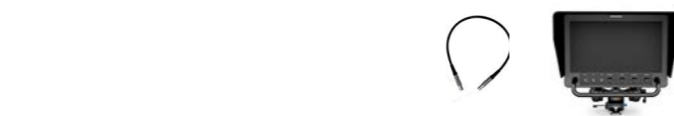

**Multicam Monitor bundle VMM-1 & MYS-1, K0.0039106**  
includes:  
K2.0037636 1x Monitor Yoke Support MYS-1  
K2.0023813 1x Viewfinder Monitor Multicam VMM-1  
includes: 1x standard sunshade plus  
K2.0012223 1x AMIRA to CCP-1 Cable 0,75m/29in  
K2.0009336 1x ALEXA Mini to CCP-1 Cable 0,75m/29in  
K2.0037711 1x VMM-1 Power Cable 0.4m/16in

## Multicam Single Components

**1820-12G FCA Fiber Camera Adaptor**  
K2.0013648

**1820 FCA Lemo assembly,** K2.0014813



**1835 Dual Link 6G Video Input Option**  
K2.0014659 (board built in)



**1820 FCA Cable set for AMIRA**  
K2.0014814



**1810U-12G SL - 1U Fibre Base Station,** [K2.0022568](#)



**1810 1U FBS Cable Set,** K2.0022570



**Skaarhoj RCP Pro ARRI V2B**  
[K2.0044481](#)



**Skaarhoj RCP Tally PVW Cable,** K2.0041503



**1810 HR30 6pin to 5pin XLR Headset Cable,** K2.0013646



**1800 2071A Tally Box,** K2.0013652



**1820 Cord Control Pod with XLR5S connect,** K2.0016149



**1830 Mounting Bracket for DTS1830B,** K2.0021324



**FBS 1810 Remote Tally Cable,** K2.0041502



**AMIRA Viewfinder MVF-1**  
K2.75004.0  
(not included in AMIRA LIVE Camera Set and needs to be ordered separately)



**SMPTE 311 Cable (20 m/65 ft),** K2.72087.0

## Microphone



**AMIRA Onboard Mikrophone Set,** [K2.0004024](#)



**Microphone Holder Bracket MHB-2,** [K2.75005.0](#)

# AMIRA / ALEXA Mini / ALEXA Mini LF Multicam - Setup



Configuration Overview | 2.3.3 / 2023.11

## Multicam Setup

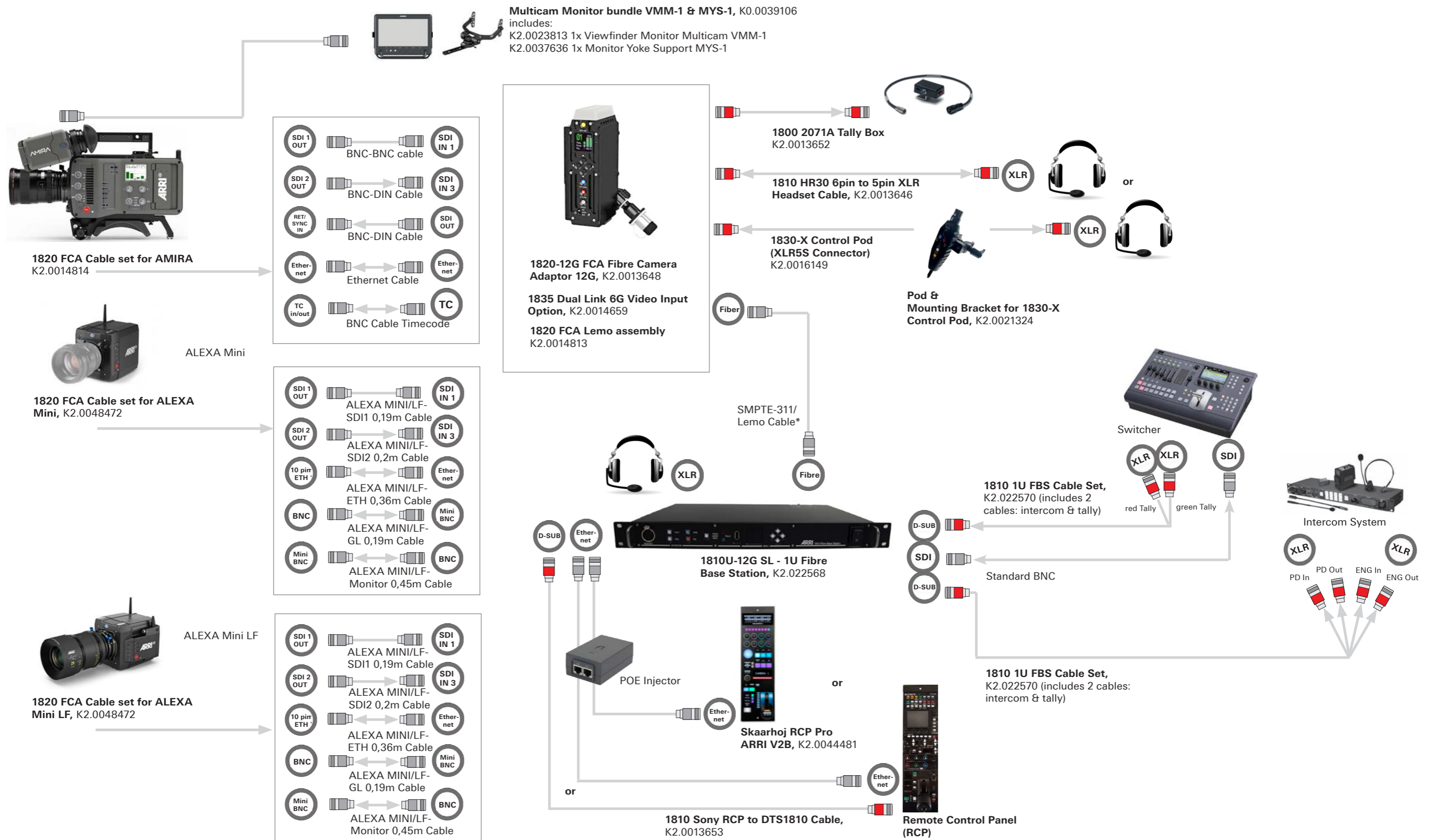

# AMIRA Multicam - Mechanical Accessories Setup



Configuration Overview | 2.4.0 / 2024.1

## Mechanical Accessories Setup

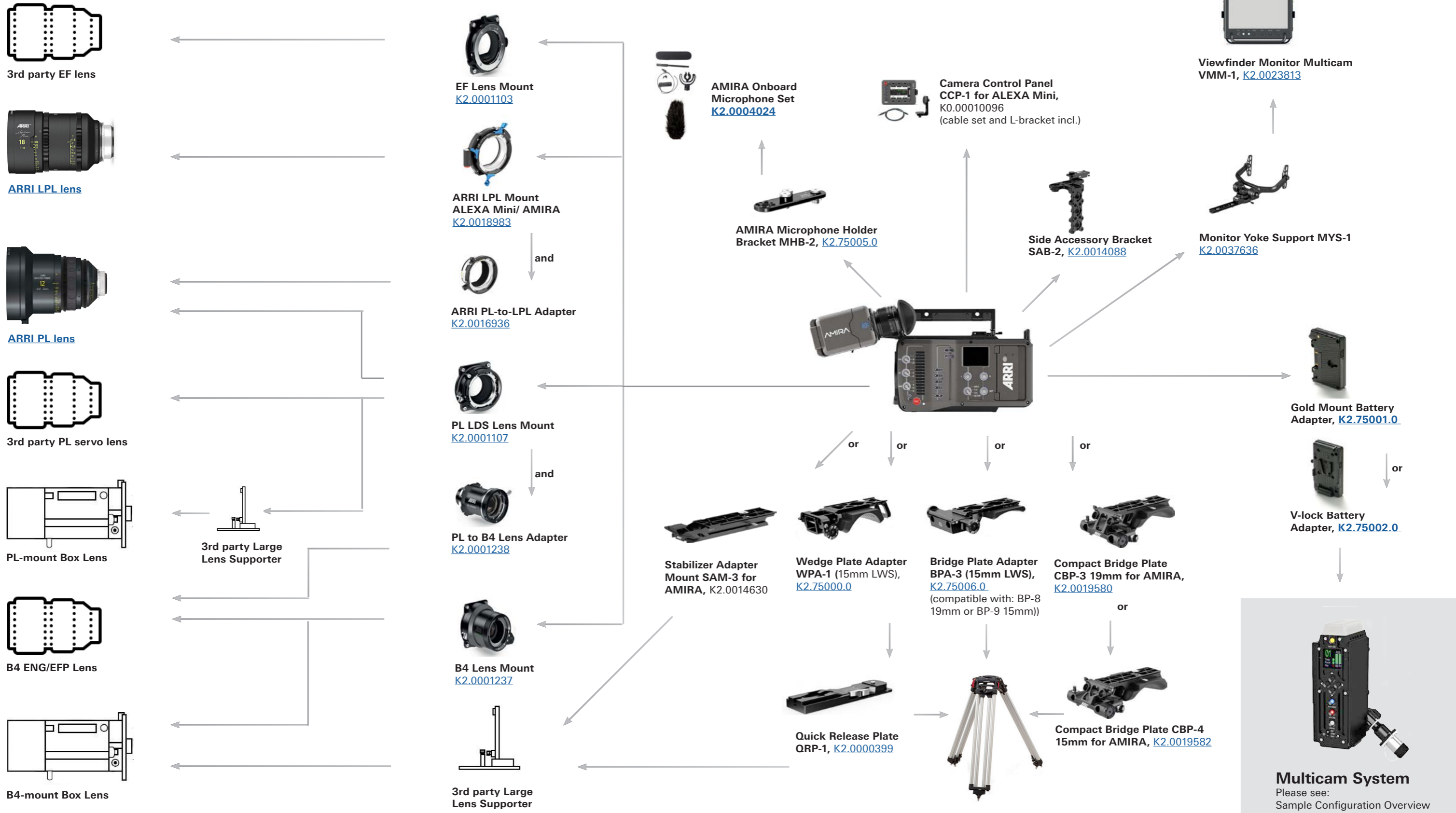

**Multicam System**  
 Please see:  
 Sample Configuration Overview  
 2.0.0 and/or 2.3.0

# Amira Multicam Cine Style Lens Setup - ECS Sample Configuration



Configuration Overview | 2.4.1 / 2023.11

## AMIRA - Cine Style Lens

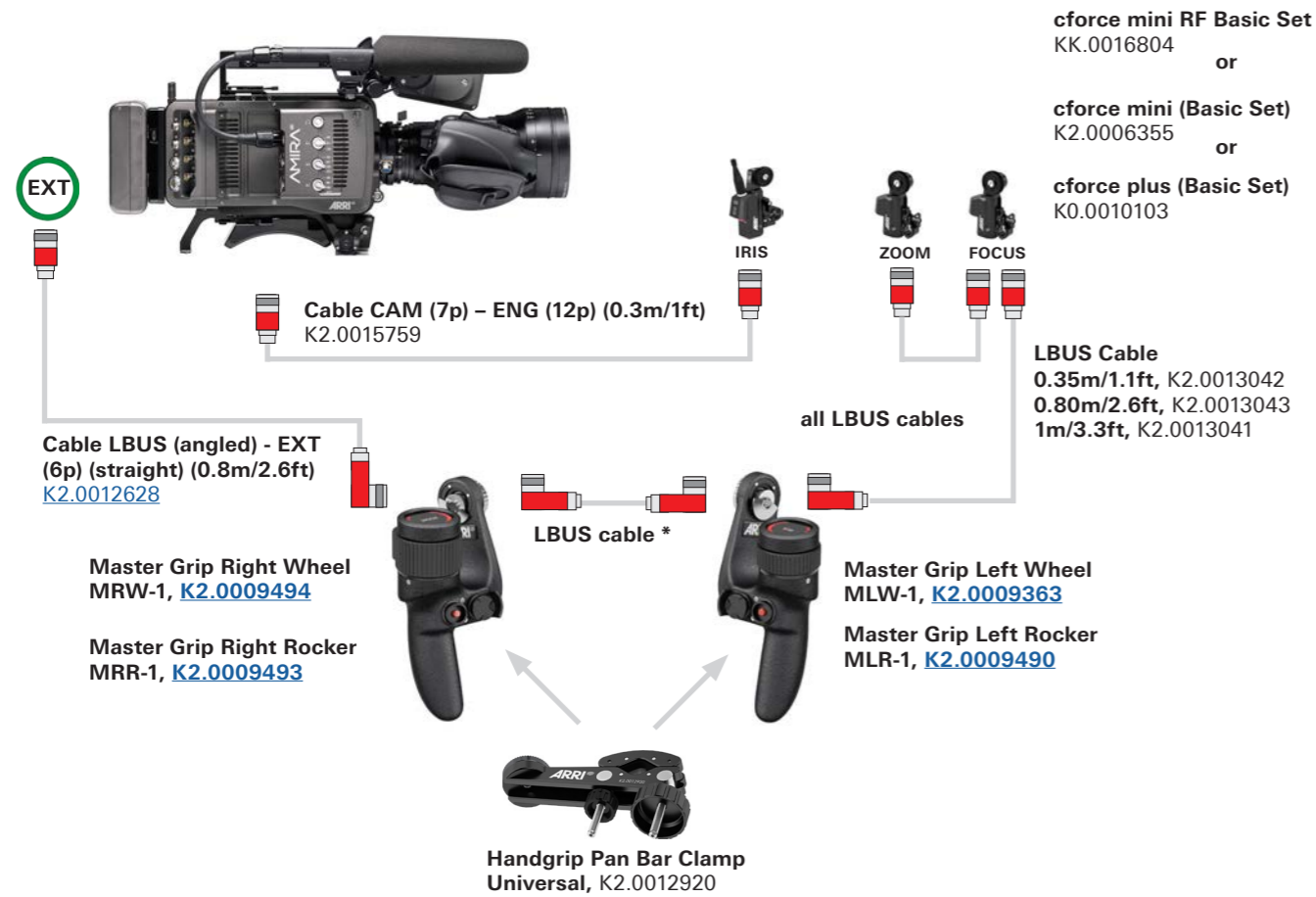

## cforce mini



## cforce plus



## LBUS Cables



- Cable LBUS (straight) to LBUS (straight)  
Length: 0.2m/8", K2.0006749
- Cable LBUS (straight) to LBUS (straight)  
Length: 0.3m/1ft, K2.0006750
- Cable LBUS (straight) to LBUS (straight)  
Length: 0.5m/1.5ft, K2.0006751
- Cable LBUS (straight) to LBUS (straight)  
Length: 0.8m/2.5ft, K2.0006752
- Cable LBUS (straight) to LBUS (straight)  
Length: 1.5m/5ft, K2.0006753
- Cable LBUS (straight) to LBUS (straight)  
Length: 3m/10ft, K2.0006754
- Cable LBUS (straight) to LBUS (straight)  
Length: 6m/20ft, K2.0006755
- Cable LBUS (straight) to LBUS (straight)  
Length: 15m/49ft, K2.0006756
- Cable LBUS (straight) to LBUS (straight)  
Length to LCS: K2.0007318

- Cable LBUS (angled) to LBUS (straight)  
Length: 0.35m/1.1ft, K2.0013042
- Cable LBUS (angled) to LBUS (straight)  
Length: 0.80m/2.6ft, K2.0013043
- Cable LBUS (angled) to LBUS (straight)  
Length: 1m/3.3ft, K2.0013041
- Cable LBUS (angled) to LBUS (angled)  
Length: 0.2m/8", K2.0012785
- Cable LBUS (angled) to LBUS (angled)  
Length: 0.6m/2ft, K2.0013040
- Cable LBUS (angled) to LBUS (angled)  
Length: 0.8m/2.6ft, K2.0012630

Cable LBUS Star (0.2m/8in). K2.0023823

## cforce mini RF

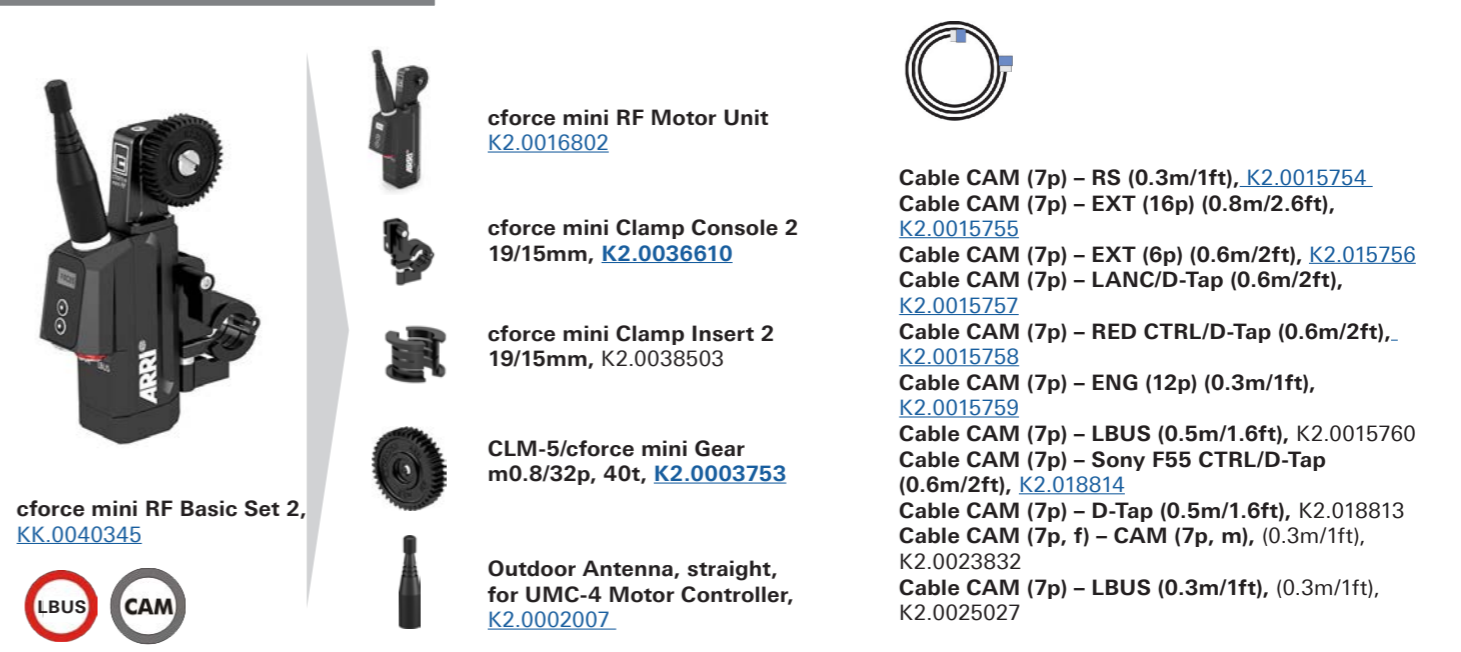

# ALEXA Mini LF Multicam - Mechanical Accessories Setup



Configuration Overview | 2.5.0 / 2023.11

## Mechanical Accessories Setup

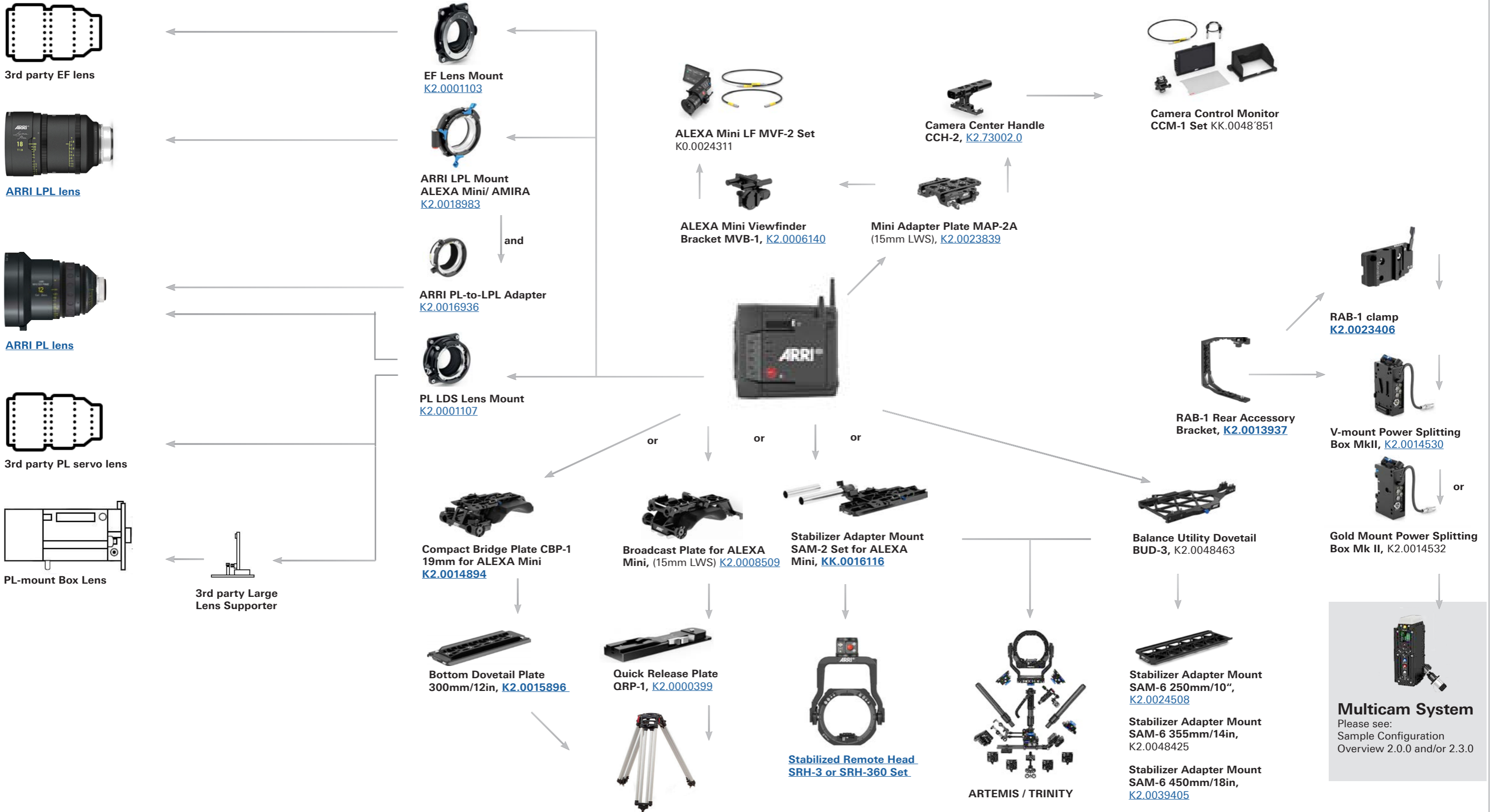

# Multicam Alexa Mini LF and Artemis Mechanical - Sample Configuration



Configuration Overview | 2.5.1 / 2023.11

## Broadcast Configuration



# ALEXA Mini Multicam - Mechanical Accessories Setup



Configuration Overview | 2.6.0 / 2023.11

## Mechanical Accessories Setup



3rd party EF lens



ARRI LPL lens



ARRI PL lens



3rd party PL servo lens



B4 ENG/EFP Lens



EF Lens Mount  
K2.0001103



ARRI LPL Mount  
ALEXA Mini/ AMIRA  
K2.0018983



ARRI PL-to-LPL Adapter  
K2.0016936



PL LDS Lens Mount  
K2.0001107



PL to B4 Lens Adapter  
K2.0001238



B4 Lens Mount  
K2.0001237



Camera Control Panel  
CCP-1 for ALEXA Mini,  
K0.00010096  
(cable set and L-bracket incl.)



ALEXA Mini Viewfinder  
MVF-1, K2.0005861



ALEXA Mini Viewfinder  
Bracket MVB-1, K2.0006140

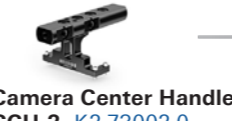

Camera Center Handle  
CCH-2, K2.73002.0



Mini Adapter Plate MAP-2A  
(15mm LWS), K2.0023839



or



Broadcast Plate for ALEXA  
Mini, (15mm LWS) K2.0008509



Stabilizer Adapter Mount  
SAM-2 Set for ALEXA  
Mini, KK.0016116



Quick Release Plate  
QRP-1, K2.0000399



Stabilized Remote Head  
SRH-3 or SRH-360 Set



Viewfinder Monitor Multicam  
VMM-1, K2.0023813



Monitor Yoke Support MYS-1  
K2.0037636



CCP-Live Camera Control  
Panel Live Upgrade Set,  
KK.0047924

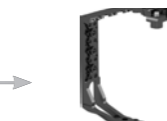

RAB-1 Rear Accessory  
Bracket, K2.0013937



RAB-1 clamp  
K2.0023406

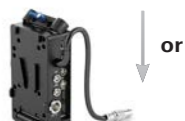

V-mount Power Splitting  
Box MkII, K2.0014530



Gold Mount Power Splitting  
Box Mk II, K2.0014532



**Multicam System**  
Please see:  
Sample Configuration  
Overview 2.0.0 and/or 2.3.0

# Multicam ALEXA Mini and Artemis Mechanical - Sample Configuration



Configuration Overview | 2.6.1 / 2023.11

## Broadcast Configuration

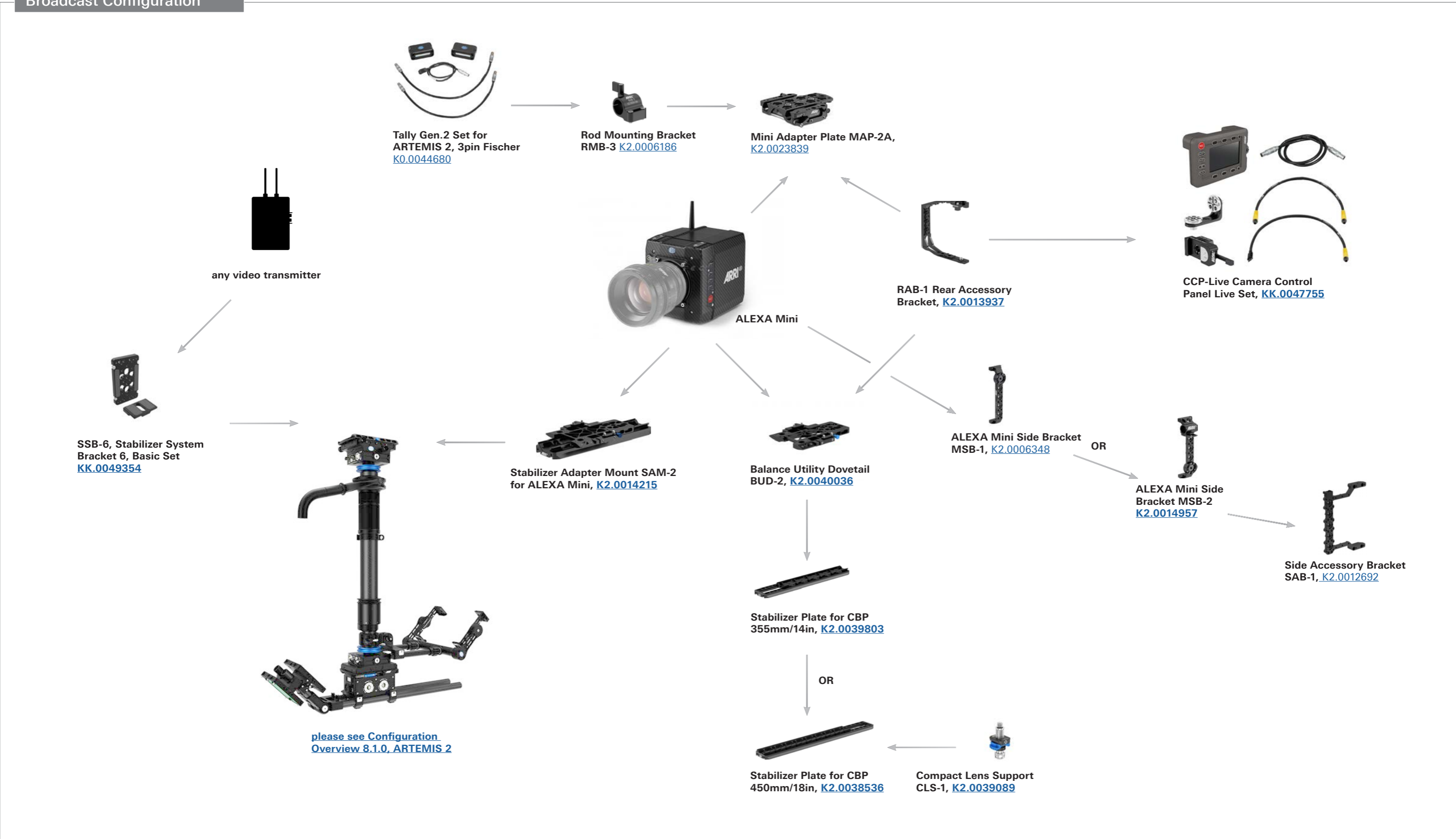

# Multicam & Stabilized Remote Heads - Sample Configuration



Configuration Overview | 2.7.0 / 2024.01

## Broadcast Configuration

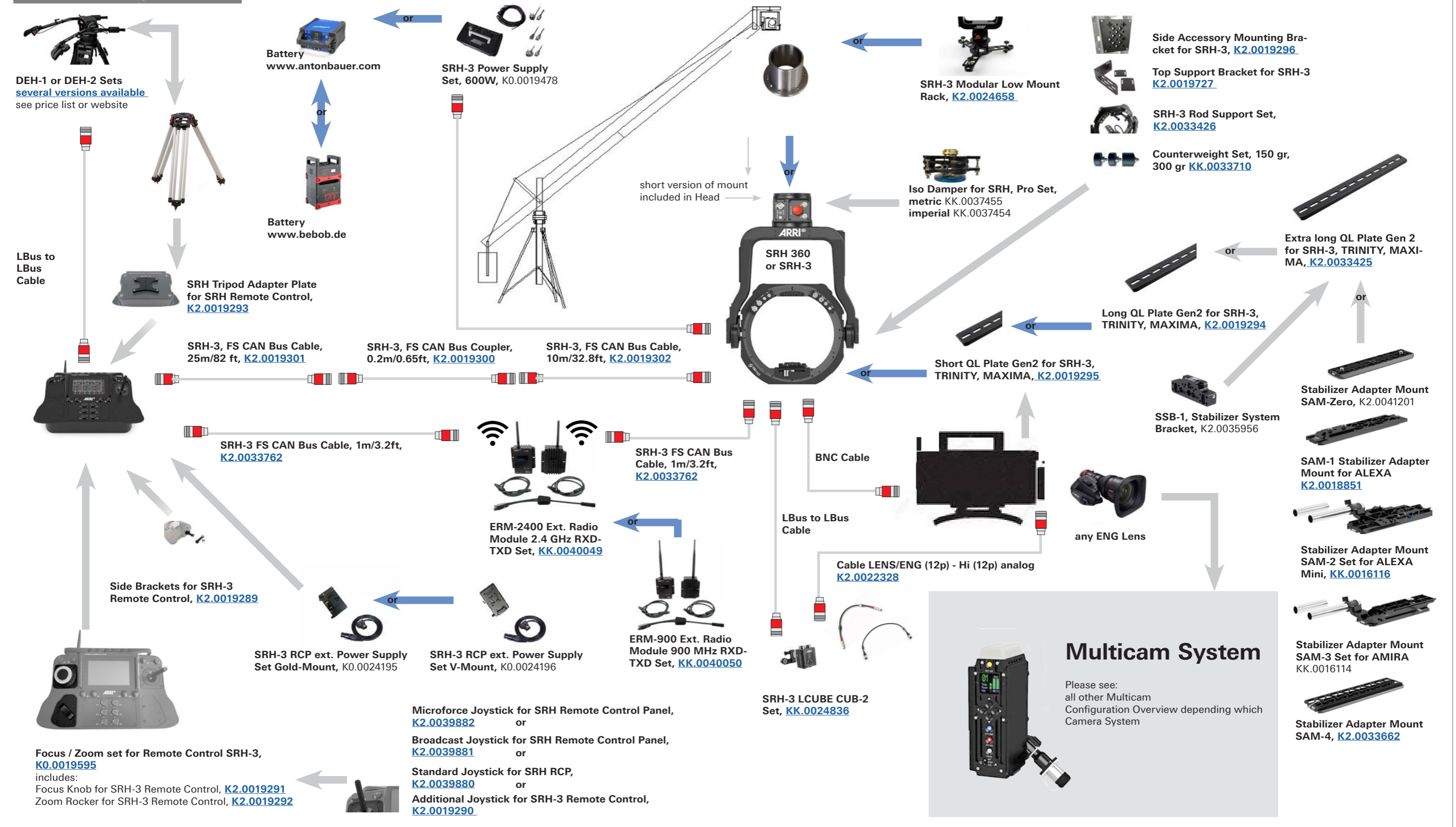

## ARRI Signature Primes

Format: Large Format & SUPER 35

 <b>12 mm</b> T1.8   Ø 134 mm <a href="#">KK.0019185</a> (m) <a href="#">KK.0019183</a> (ft)	 <b>15 mm</b> T1.8   Ø 156 mm <a href="#">KK.0019188</a> (m) <a href="#">KK.0019187</a> (ft)	 <b>18 mm</b> T1.8   Ø 114 mm <a href="#">KK.0019191</a> (m) <a href="#">KK.0019189</a> (ft)	 <b>21 mm</b> T1.8   Ø 114 mm <a href="#">KK.0019193</a> (m) <a href="#">KK.0019192</a> (ft)	 <b>25 mm</b> T1.8   Ø 114 mm <a href="#">KK.0019196</a> (m) <a href="#">KK.0019194</a> (ft)	 <b>29 mm</b> T1.8   Ø 114 mm <a href="#">KK.0019199</a> (m) <a href="#">KK.0019197</a> (ft)
 <b>35 mm</b> T1.8   Ø 114 mm <a href="#">KK.0019102</a> (m) <a href="#">KK.0019099</a> (ft)	 <b>40 mm</b> T1.8   Ø 114 mm <a href="#">KK.0019201</a> (m) <a href="#">KK.0019200</a> (ft)	 <b>47 mm</b> T1.8   Ø 114 mm <a href="#">KK.0019105</a> (m) <a href="#">KK.0019104</a> (ft)	 <b>58 mm</b> T1.8   Ø 114 mm <a href="#">KK.0019203</a> (m) <a href="#">KK.0019202</a> (ft)	 <b>75 mm</b> T1.8   Ø 114 mm <a href="#">KK.0019107</a> (m) <a href="#">KK.0019106</a> (ft)	 <b>95 mm</b> T1.8   Ø 114 mm <a href="#">KK.0019205</a> (m) <a href="#">KK.0019204</a> (ft)
 <b>125 mm</b> T1.8   Ø 114 mm <a href="#">KK.0019109</a> (m) <a href="#">KK.0019108</a> (ft)	 <b>150 mm</b> T1.8   Ø 114 mm <a href="#">KK.0019207</a> (m) <a href="#">KK.0019206</a> (ft)	 <b>200 mm</b> T2.5   Ø 114 mm <a href="#">KK.0019210</a> (m) <a href="#">KK.0019209</a> (ft)	 <b>280 mm</b> T2.8   Ø 134 mm <a href="#">KK.0019213</a> (m) <a href="#">KK.0019211</a> (ft) compatible with Signature Zoom Extender 1.7x	ARRI LPL Mount Lens Rear Cap Extended, <a href="#">K2.0020097</a> ARRI Signature Prime Front Cap Ø 156mm, <a href="#">K2.0019316</a> ARRI Signature Prime Front Cap Ø 134mm, <a href="#">K2.0019314</a> ARRI Signature Prime Front Cap Ø 114mm, <a href="#">K2.0019308</a>	

## ARRI Signature Zooms

Format: Large Format & SUPER 35

 <b>SZ 16-32 mm</b> T2.8   Ø 156 mm <a href="#">KK.0038601</a> (m) <a href="#">KK.0038602</a> (ft) ARRI Signature Zoom Front Cap, <a href="#">K2.0019316</a>	 <b>SZ 24-75 mm</b> T2.8   Ø 114 mm <a href="#">KK.0038603</a> (m) <a href="#">KK.0038604</a> (ft) ARRI Signature Zoom Front Cap, <a href="#">K2.0019308</a>
 <b>SZ 45-135 mm</b> T2.8   Ø 114 mm <a href="#">KK.0038605</a> (m) <a href="#">KK.0038606</a> (ft) ARRI Signature Zoom Front Cap, <a href="#">K2.0019308</a>	 <b>SZ 65-300mm/Extender 1.7x</b> T2.8   Ø 156 mm <a href="#">KK.0038607</a> (m) <a href="#">KK.0038608</a> (ft) ARRI Signature Zoom Front Cap, <a href="#">K2.0019316</a>

### Matte Box Checker

Find out which matte box you can use with which ARRI lens to avoid vignetting

## ARRI Impression V Filters

### ARRI Impression V Filter Kit

- [KK.0048312](#) includes:
- 1x ARRI Impression V Aluminum Case
  - 1x ARRI Impression V Filter 070P
  - 1x ARRI Impression V Filter 140P
  - 1x ARRI Impression V Filter 230P
  - 1x ARRI Impression V Filter 330P
  - 1x ARRI Impression V Filter 050N
  - 1x ARRI Impression V Filter 100N
  - 1x ARRI Impression V Filter 200N
  - 1x ARRI Impression V Filter 290N
  - 1x ARRI Impression V Shim Set
  - 1x ARRI Impression V Velcro® Set
  - 1x Torque Screwdriver



- ARRI Impression V 070P Filter Pack, [K2.0048139](#)** includes: 3x ARRI Impression V Filter 070P and 3x ARRI Impression V Velcro® Set
- ARRI Impression V 140P Filter Pack, [K2.0048140](#)** includes: 3x ARRI Impression V Filter 140P and 3x ARRI Impression V Velcro® Set
- ARRI Impression V 230P Filter Pack, [K2.0048141](#)** includes: 3x ARRI Impression V Filter 230P and 3x ARRI Impression V Velcro® Set
- ARRI Impression V 330P Filter Pack, [K2.0048142](#)** includes: 3x ARRI Impression V Filter 330P and 3x ARRI Impression V Velcro® Set

- ARRI Impression V Shim Pack, [K2.0048147](#)** includes: 6x ARRI Impression V Shim Set
- ARRI Impression V Velcro® Pack, [K2.0048148](#)** includes: 6x ARRI Impression V Velcro® Set



- ARRI Impression V 050N Filter Pack, [K2.0048143](#)** Includes: 3x ARRI Impression V Filter 050N and 1x ARRI Impression V Shim Set and 2x ARRI Impression V Velcro® Set
- ARRI Impression V 100N Filter Pack, [K2.0048144](#)** includes: 3x ARRI Impression V Filter 100N and 1x ARRI Impression V Shim Set and 2x ARRI Impression V Velcro® Set
- ARRI Impression V 200N Filter Pack, [K2.0048145](#)** includes: 3x ARRI Impression V Filter 200N and 1x ARRI Impression V Shim Set and 2x ARRI Impression V Velcro® Set
- ARRI Impression V 290N Filter Pack, [K2.0048146](#)** includes: 3x ARRI Impression V Filter 290N and 1x ARRI Impression V Shim Set and 2x ARRI Impression V Velcro® Set

ARRI Impression V Filters are compatible with ARRI ALEXA 35 / ALEXA Mini LF / ALEXA LF / ALEXA 65 / ALEXA Classic / ALEXA XT / ALEXA SXT.  
ARRI Impression V Filters are not compatible with ALEXA Mini and AMIRA. 3rd party cameras and adapters need to be checked

## ARRI Signature Zoom Extender



### ARRI Signature Zoom Extender 1.7x

[KK.0038609](#)  
Extender included in Signature Zoom 65-300mm KK-Sets  
SZ 65-300/T2.8 & Extender 1.7x --> 110-510/T4.9  
Extender also compatible with Signature Prime SP 280 SP 280/T2.8 & Extender 1.7x --> 480/T4.9

Front Cap, [K5.0015461](#)



### Magnetic Rear Filter Holder

[K2.0019522](#)  
fits Signature Primes, Signature Zooms & Signature Zoom Extender 1.7x  
included with each Signature lens / extender

# LPL Large Positive Lock - Compatibility Chart ARRI Models and 3rd Party Adapters



Configuration Overview | 3.1.1 / 2025.01

## LPL Compatibility

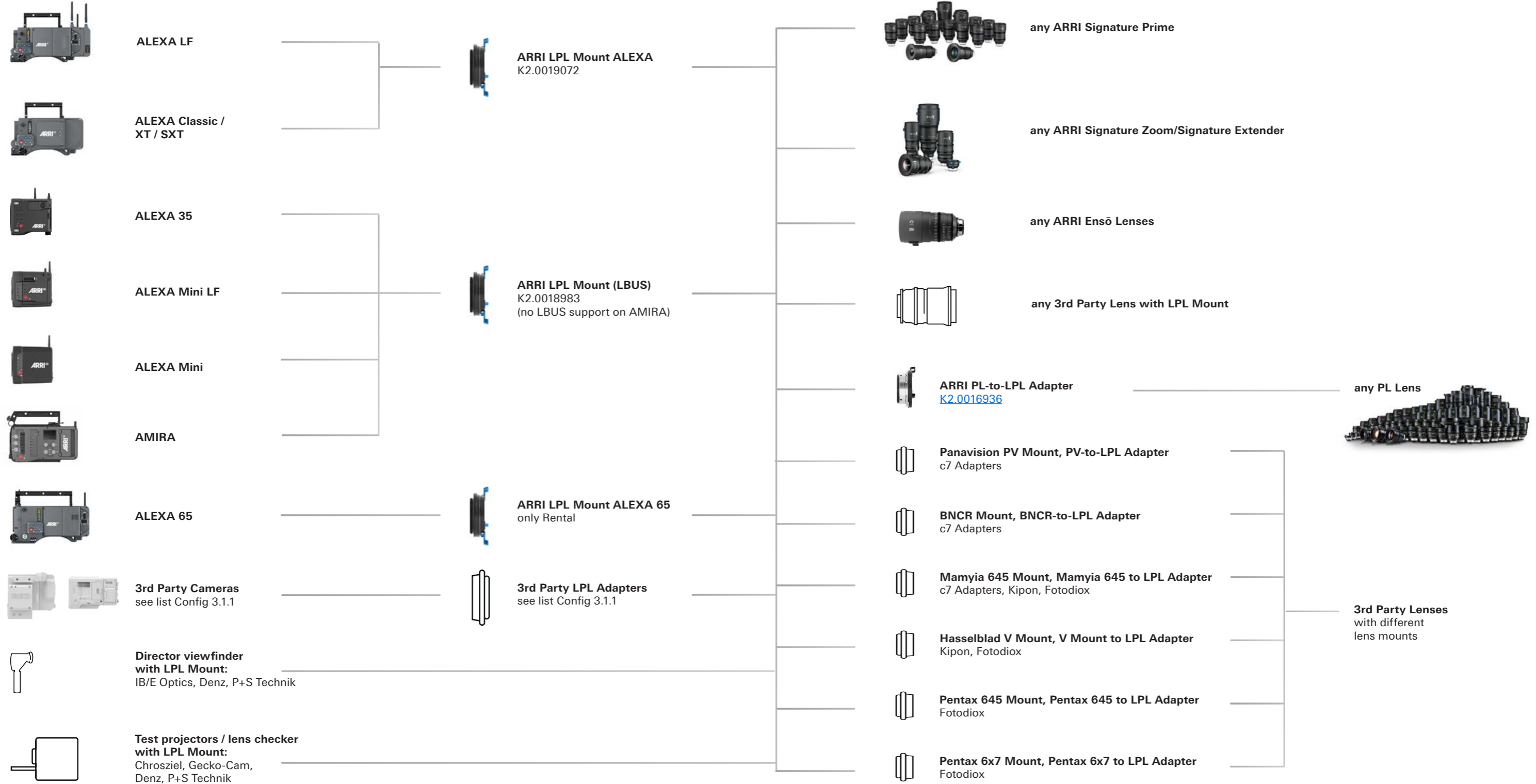

# LPL Large Positive Lock - Compatibility Chart 3rd Party



## Configuration Overview | 3.1.2 / 2025.01

3rd Party Camera Models	Camera Lens Mount Interface	Required Camera Mount Adapter <small>*native LPL camera mount</small>	Lens Mount (lens-side)	3rd Party LPL-Lens Mount Adapter Manufacturer						
				c7 Adapter	Wooden Camera	KipperTie	Kipon	FotodioX	Vocas	Leitz
Phantom Flex Phantom Flex 4K Phantom VEO 4K	Phantom Flex Phantom Flex Phantom Flex	LPL-Phantom Flex Mount LPL-Phantom Flex Mount LPL-Phantom Flex Mount	any LPL mount lens any LPL mount lens any LPL mount lens	✓ ✓ ✓						
RED Weapon RED Epic RED Scarlet Dragon RED Epic/Scarlet W RED Epic/Scarlet M-X RED Gemini RED Monstro RED Helium	RED DSMC2 RED DSMC2 RED DSMC2 RED DSMC2 RED DSMC2 RED DSMC2 RED DSMC2 RED DSMC2	LPL-RED DSMC2 Mount LPL-RED DSMC2 Mount LPL-RED DSMC2 Mount LPL-RED DSMC2 Mount LPL-RED DSMC2 Mount LPL-RED DSMC2 Mount LPL-RED DSMC2 Mount LPL-RED DSMC2 Mount	any LPL mount lens any LPL mount lens any LPL mount lens any LPL mount lens any LPL mount lens any LPL mount lens any LPL mount lens any LPL mount lens	✓ ✓ ✓ ✓ ✓ ✓ ✓ ✓	✓ ✓ ✓ ✓ ✓ ✓ ✓ ✓	✓ ✓ ✓ ✓ ✓ ✓ ✓ ✓	✓ ✓ ✓ ✓ ✓ ✓ ✓ ✓			
RED Ranger RED Raptor	RED Ranger Canon RF	LPL-RED Ranger LPL-RED Ranger	any LPL mount lens any LPL mount lens	✓ ✓	✓ ✓	✓ ✓	✓ ✓			
RED Komodo Canon EOS R Canon EOS RP Canon EOS R5	Canon RF Canon RF Canon RF Canon RF	LPL-Canon RF LPL-Canon RF LPL-Canon RF LPL-Canon RF	any LPL mount lens any LPL mount lens any LPL mount lens any LPL mount lens	✓ ✓ ✓ ✓	✓ ✓ ✓ ✓	✓ ✓ ✓ ✓	✓ ✓ ✓ ✓			
Sony Venice / Sony Venice 2	Sony Venice	LPL-Sony Venice	any LPL mount lens	✓	✓	✓	✓		✓	✓
Sony FS7 / Sony FS5 Sony FS100 Sony FS700 Sony EA50E Sony VG900 Sony A7 / A7 II / A7 III / A7 IV Sony A7S / A7S II / A7S III Sony A7R / A7R II / A7RIII Sony A7R IV / A7R V Sony A9 Sony A6300 / A5100 Sony A5000 / A6000 Sony A3000 Sony NEX-5 / NEX-6 Sony NEX-3 / NEX-7	Sony E Mount Sony E Mount Sony E Mount Sony E Mount Sony E Mount Sony E Mount Sony E Mount Sony E Mount Sony E Mount Sony E Mount Sony E Mount Sony E Mount Sony E Mount Sony E Mount Sony E Mount Sony E Mount Sony E Mount Sony E Mount Sony E Mount	LPL-Sony E Mount LPL-Sony E Mount LPL-Sony E Mount LPL-Sony E Mount LPL-Sony E Mount LPL-Sony E Mount LPL-Sony E Mount LPL-Sony E Mount LPL-Sony E Mount LPL-Sony E Mount LPL-Sony E Mount LPL-Sony E Mount LPL-Sony E Mount LPL-Sony E Mount LPL-Sony E Mount LPL-Sony E Mount LPL-Sony E Mount LPL-Sony E Mount LPL-Sony E Mount	any LPL mount lens any LPL mount lens any LPL mount lens any LPL mount lens any LPL mount lens any LPL mount lens any LPL mount lens any LPL mount lens any LPL mount lens any LPL mount lens any LPL mount lens any LPL mount lens any LPL mount lens any LPL mount lens any LPL mount lens any LPL mount lens any LPL mount lens any LPL mount lens any LPL mount lens	✓ ✓ ✓ ✓ ✓ ✓ ✓ ✓ ✓ ✓ ✓ ✓ ✓ ✓ ✓ ✓ ✓ ✓ ✓ ✓	✓ ✓ ✓ ✓ ✓ ✓ ✓ ✓ ✓ ✓ ✓ ✓ ✓ ✓ ✓ ✓ ✓ ✓ ✓ ✓	✓ ✓ ✓ ✓ ✓ ✓ ✓ ✓ ✓ ✓ ✓ ✓ ✓ ✓ ✓ ✓ ✓ ✓ ✓ ✓	✓ ✓ ✓ ✓ ✓ ✓ ✓ ✓ ✓ ✓ ✓ ✓ ✓ ✓ ✓ ✓ ✓ ✓ ✓ ✓			
Nikon Z6, Nikon Z7 Nikon Z8, Nikon Z9	Nikon Z Mount Nikon Z Mount	LPL-Nikon Z Mount LPL-Nikon Z Mount	any LPL mount lens any LPL mount lens	✓ ✓				✓ ✓		
Leica SL Leica TL / Leica TL 2 Leica T / Leica CL Panasonic Lumix S1 Panasonic Lumix S1R Panasonic Lumix S1H Panasonic Lumix S5 Sigma FP	Leica L Mount Leica L Mount Leica L Mount Leica L Mount Leica L Mount Leica L Mount Leica L Mount Leica L Mount	LPL-Leica L Mount LPL-Leica L Mount LPL-Leica L Mount LPL-Leica L Mount LPL-Leica L Mount LPL-Leica L Mount LPL-Leica L Mount LPL-Leica L Mount	any LPL mount lens any LPL mount lens any LPL mount lens any LPL mount lens any LPL mount lens any LPL mount lens any LPL mount lens any LPL mount lens	✓ ✓ ✓ ✓ ✓ ✓ ✓ ✓	✓ ✓ ✓ ✓ ✓ ✓ ✓ ✓	✓ ✓ ✓ ✓ ✓ ✓ ✓ ✓	✓ ✓ ✓ ✓ ✓ ✓ ✓ ✓	✓ ✓ ✓ ✓ ✓ ✓ ✓ ✓		✓ ✓ ✓ ✓ ✓ ✓ ✓ ✓
GFX 100 / GFX 50S GFX 50R / GFX 100 II	Fuji G Mount Fuji G Mount	LPL-Fuji G Mount LPL-Fuji G Mount	any LPL mount lens any LPL mount lens	✓ ✓	✓ ✓			✓ ✓		
X1D 50c / X1D II 50c	Hasselblad XCD	LPL-XCD Mount	any LPL mount lens					✓		
MAVO / MAVO LF TERRA 4K	Kinefinity Kinefinity	KineMOUNT LPL Mount* KineMOUNT LPL Mount*	any LPL mount lens any LPL mount lens							
Achtel 9x7 DCC	9x7 DCC	9x7 DCC LPL Mount*	any LPL mount lens							

# 5x Signature Primes with ALEXA Mini LF Ready to Shoot Sets



Configuration Overview | 3.1.4 / 2022.11

## 5x Signature Primes



random pictures

## Ready to Shoot Set B-Mount

**5x Signature Primes (M) & ALEXA Mini LF Ready to Shoot Set B**, K0.0048012

includes:  
[KK.0019196](#) ARRI Signature Prime 25/T1.8 **M**  
[KK.0019102](#) ARRI Signature Prime 35/T1.8 **M**  
[KK.0019105](#) ARRI Signature Prime 47/T1.8 **M**  
[KK.0019107](#) ARRI Signature Prime 75/T1.8 **M**  
[KK.0019109](#) ARRI Signature Prime 125/T1.8 **M**  
 K1.0024074 1x ALEXA Mini LF camera body  
 K2.0018983 1x ARRI LPL Mount (LBUS)  
[K2.0016936](#) 1x ARRI PL-to-LPL Adapter  
 K2.0024130 2x CODEX Compact Drive 1TB (CA08-1024)  
 K2.0020916 1x Multi Viewfinder MVF-2  
 K2.0023915 1x Cable VF (0.35m/1.15ft)  
 K2.0023943 1x Cable VF (0.5m/1.5ft)  
 K2.0023839 1x Mini Adapter Plate MAP-2A  
 K2.0006140 1x Mini Viewfinder Bracket MVB-1  
 K2.73002.0 1x Center Camera Handle CCH-2  
 K2.0023546 1x Mini Side Bracket MSB-3  
 K2.0014957 1x Mini Side Bracket MSB-2  
 K2.0014894 1x Compact Bridge Plate CBP-1 **19mm**  
 K2.0013937 1x Rear Accessory Bracket RAB-1  
 K2.0023406 1x RAB-1 Clamp 2  
 K2.0006186 1x Rod Mounting Bracket RMB-3  
 K2.66255.0 1x 15mm Reduction Insert  
 K2.0024114 1x **B-Mount Power Splitting Box**  
 K2.0015896 1x Bottom Dovetail Plate 300mm/12in  
 K2.75007.0 1x Camera Power Cable Straight 2m/6.6in KC50

## Ready to Shoot Set V-Mount

**5x Signature Primes (M) & ALEXA Mini LF Ready to Shoot Set V**, K0.0048014

includes:  
[KK.0019196](#) ARRI Signature Prime 25/T1.8 **M**  
[KK.0019102](#) ARRI Signature Prime 35/T1.8 **M**  
[KK.0019105](#) ARRI Signature Prime 47/T1.8 **M**  
[KK.0019107](#) ARRI Signature Prime 75/T1.8 **M**  
[KK.0019109](#) ARRI Signature Prime 125/T1.8 **M**  
 K1.0024074 1x ALEXA Mini LF camera body  
 K2.0018983 1x ARRI LPL Mount (LBUS)  
[K2.0016936](#) 1x ARRI PL-to-LPL Adapter  
 K2.0024130 2x CODEX Compact Drive 1TB (CA08-1024)  
 K2.0020916 1x Multi Viewfinder MVF-2  
 K2.0023915 1x Cable VF (0.35m/1.15ft)  
 K2.0023943 1x Cable VF (0.5m/1.5ft)  
 K2.0023839 1x Mini Adapter Plate MAP-2A  
 K2.0006140 1x Mini Viewfinder Bracket MVB-1  
 K2.73002.0 1x Center Camera Handle CCH-2  
 K2.0023546 1x Mini Side Bracket MSB-3  
 K2.0014957 1x Mini Side Bracket MSB-2  
 K2.0014894 1x Compact Bridge Plate CBP-1 **19mm**  
 K2.0013937 1x Rear Accessory Bracket RAB-1  
 K2.0023406 1x RAB-1 Clamp 2  
 K2.0006186 1x Rod Mounting Bracket RMB-3  
 K2.66255.0 1x 15mm Reduction Insert  
 K2.0014530 1x **V-Mount Power Splitting Box MkII**  
 K2.0015896 1x Bottom Dovetail Plate 300mm/12in  
 K2.75007.0 1x Camera Power Cable Straight 2m/6.6in KC-50

## Ready to Shoot Set Gold-Mount

**5x Signature Primes (M) & ALEXA Mini LF Ready to Shoot Set Gold**, K0.0048013

includes:  
[KK.0019196](#) ARRI Signature Prime 25/T1.8 **M**  
[KK.0019102](#) ARRI Signature Prime 35/T1.8 **M**  
[KK.0019105](#) ARRI Signature Prime 47/T1.8 **M**  
[KK.0019107](#) ARRI Signature Prime 75/T1.8 **M**  
[KK.0019109](#) ARRI Signature Prime 125/T1.8 **M**  
 K1.0024074 1x ALEXA Mini LF camera body  
 K2.0018983 1x ARRI LPL Mount (LBUS)  
[K2.0016936](#) 1x ARRI PL-to-LPL Adapter  
 K2.0024130 2x CODEX Compact Drive 1TB (CA08-1024)  
 K2.0020916 1x Multi Viewfinder MVF-2  
 K2.0023915 1x Cable VF (0.35m/1.15ft)  
 K2.0023943 1x Cable VF (0.5m/1.5ft)  
 K2.0023839 1x Mini Adapter Plate MAP-2A  
 K2.0006140 1x Mini Viewfinder Bracket MVB-1  
 K2.73002.0 1x Center Camera Handle CCH-2  
 K2.0023546 1x Mini Side Bracket MSB-3  
 K2.0014957 1x Mini Side Bracket MSB-2  
 K2.0014894 1x Compact Bridge Plate CBP-1 **19mm**  
 K2.0013937 1x Rear Accessory Bracket RAB-1  
 K2.0023406 1x RAB-1 Clamp 2  
 K2.0006186 1x Rod Mounting Bracket RMB-3  
 K2.66255.0 1x 15mm Reduction Insert  
 K2.0014532 1x **Gold Mount Power Splitting Box Mk II**  
 K2.0015896 1x Bottom Dovetail Plate 300mm/12in  
 K2.75007.0 1x Camera Power Cable Straight 2m/6.6in KC-50

## ALEXA Mini LF Ready to Shoot Set



**5x Signature Primes (F) & ALEXA Mini LF Ready to Shoot Set B**, K0.0048007

includes:  
[KK.0019194](#) ARRI Signature Prime 25/T1.8 **F**  
[KK.0019099](#) ARRI Signature Prime 35/T1.8 **F**  
[KK.0019104](#) ARRI Signature Prime 47/T1.8 **F**  
[KK.0019106](#) ARRI Signature Prime 75/T1.8 **F**  
[KK.0019108](#) ARRI Signature Prime 125/T1.8 **F**  
 K1.0024074 1x ALEXA Mini LF camera body  
 K2.0018983 1x ARRI LPL Mount (LBUS)  
[K2.0016936](#) 1x ARRI PL-to-LPL Adapter  
 K2.0024130 2x CODEX Compact Drive 1TB (CA08-1024)  
 K2.0020916 1x Multi Viewfinder MVF-2  
 K2.0023915 1x Cable VF (0.35m/1.15ft)  
 K2.0023943 1x Cable VF (0.5m/1.5ft)  
 K2.0023839 1x Mini Adapter Plate MAP-2A  
 K2.0006140 1x Mini Viewfinder Bracket MVB-1  
 K2.73002.0 1x Center Camera Handle CCH-2  
 K2.0023546 1x Mini Side Bracket MSB-3  
 K2.0014957 1x Mini Side Bracket MSB-2  
 K2.0014894 1x Compact Bridge Plate CBP-1 **19mm**  
 K2.0013937 1x Rear Accessory Bracket RAB-1  
 K2.0023406 1x RAB-1 Clamp 2  
 K2.0006186 1x Rod Mounting Bracket RMB-3  
 K2.66255.0 1x 15mm Reduction Insert  
 K2.0024114 1x **B-Mount Power Splitting Box**  
 K2.0015896 1x Bottom Dovetail Plate 300mm/12in  
 K2.75007.0 1x Camera Power Cable Straight 2m/6.6in KC-50

**5x Signature Primes (F) & ALEXA Mini LF Ready to Shoot Set V**, K0.0048009

includes:  
[KK.0019194](#) ARRI Signature Prime 25/T1.8 **F**  
[KK.0019099](#) ARRI Signature Prime 35/T1.8 **F**  
[KK.0019104](#) ARRI Signature Prime 47/T1.8 **F**  
[KK.0019106](#) ARRI Signature Prime 75/T1.8 **F**  
[KK.0019108](#) ARRI Signature Prime 125/T1.8 **F**  
 K1.0024074 1x ALEXA Mini LF camera body  
 K2.0018983 1x ARRI LPL Mount (LBUS)  
[K2.0016936](#) 1x ARRI PL-to-LPL Adapter  
 K2.0024130 2x CODEX Compact Drive 1TB (CA08-1024)  
 K2.0020916 1x Multi Viewfinder MVF-2  
 K2.0023915 1x Cable VF (0.35m/1.15ft)  
 K2.0023943 1x Cable VF (0.5m/1.5ft)  
 K2.0023839 1x Mini Adapter Plate MAP-2A  
 K2.0006140 1x Mini Viewfinder Bracket MVB-1  
 K2.73002.0 1x Center Camera Handle CCH-2  
 K2.0023546 1x Mini Side Bracket MSB-3  
 K2.0014957 1x Mini Side Bracket MSB-2  
 K2.0014894 1x Compact Bridge Plate CBP-1 **19mm**  
 K2.0013937 1x Rear Accessory Bracket RAB-1  
 K2.0023406 1x RAB-1 Clamp 2  
 K2.0006186 1x Rod Mounting Bracket RMB-3  
 K2.66255.0 1x 15mm Reduction Insert  
 K2.0014530 1x **V-Mount Power Splitting Box MkII**  
 K2.0015896 1x Bottom Dovetail Plate 300mm/12in  
 K2.75007.0 1x Camera Power Cable Straight 2m/6.6in KC-50

**5x Signature Primes (F) & ALEXA Mini LF Ready to Shoot Set Gold**, K0.0048008

includes:  
[KK.0019194](#) ARRI Signature Prime 25/T1.8 **F**  
[KK.0019099](#) ARRI Signature Prime 35/T1.8 **F**  
[KK.0019104](#) ARRI Signature Prime 47/T1.8 **F**  
[KK.0019106](#) ARRI Signature Prime 75/T1.8 **F**  
[KK.0019108](#) ARRI Signature Prime 125/T1.8 **F**  
 K1.0024074 1x ALEXA Mini LF camera body  
 K2.0018983 1x ARRI LPL Mount (LBUS)  
[K2.0016936](#) 1x ARRI PL-to-LPL Adapter  
 K2.0024130 2x CODEX Compact Drive 1TB (CA08-1024)  
 K2.0020916 1x Multi Viewfinder MVF-2  
 K2.0023915 1x Cable VF (0.35m/1.15ft)  
 K2.0023943 1x Cable VF (0.5m/1.5ft)  
 K2.0023839 1x Mini Adapter Plate MAP-2A  
 K2.0006140 1x Mini Viewfinder Bracket MVB-1  
 K2.73002.0 1x Center Camera Handle CCH-2  
 K2.0023546 1x Mini Side Bracket MSB-3  
 K2.0014957 1x Mini Side Bracket MSB-2  
 K2.0014894 1x Compact Bridge Plate CBP-1 **19mm**  
 K2.0013937 1x Rear Accessory Bracket RAB-1  
 K2.0023406 1x RAB-1 Clamp 2  
 K2.0006186 1x Rod Mounting Bracket RMB-3  
 K2.66255.0 1x 15mm Reduction Insert  
 K2.0014532 1x **Gold Mount Power Splitting Box Mk II**  
 K2.0015896 1x Bottom Dovetail Plate 300mm/12in  
 K2.75007.0 1x Camera Power Cable Straight 2m/6.6in KC-50

# 8x Signature Primes with ALEXA Mini LF Ready to Shoot Sets



Configuration Overview | 3.1.5 / 2023.11

## 8x Signature Primes



random pictures

## Ready to Shoot Set B-Mount

**8x Signature Primes (M) & ALEXA Mini LF Ready to Shoot Set B**, K0.0048022

- includes:
- [KK.0019191](#) ARRI Signature Prime 18/T1.8 **M**
  - [KK.0019196](#) ARRI Signature Prime 25/T1.8 **M**
  - [KK.0019102](#) ARRI Signature Prime 35/T1.8 **M**
  - [KK.0019105](#) ARRI Signature Prime 47/T1.8 **M**
  - [KK.0019203](#) ARRI Signature Prime 58/T1.8 **M**
  - [KK.0019107](#) ARRI Signature Prime 75/T1.8 **M**
  - [KK.0019109](#) ARRI Signature Prime 125/T1.8 **M**
  - [KK.0019210](#) ARRI Signature Prime 200/T2.5 **M**
  - K1.0024074 1x ALEXA Mini LF camera body
  - K2.0018983 1x ARRI LPL Mount (LBUS)
  - [K2.0016936](#) 1x ARRI PL-to-LPL Adapter
  - K2.0024130 2x CODEX Compact Drive 1TB (CA08-1024)
  - K2.0020916 1x Multi Viewfinder MVF-2
  - K2.0023915 1x Cable VF (0.35m/1.15ft)
  - K2.0023943 1x Cable VF (0.5m/1.5ft)
  - K2.0023839 1x Mini Adapter Plate MAP-2A
  - K2.0006140 1x Mini Viewfinder Bracket MVB-1
  - K2.73002.0 1x Center Camera Handle CCH-2
  - K2.0023546 1x Mini Side Bracket MSB-3
  - K2.0014957 1x Mini Side Bracket MSB-2
  - K2.0014894 1x Compact Bridge Plate CBP-1 **19mm**
  - K2.0013937 1x Rear Accessory Bracket RAB-1
  - K2.0023406 1x RAB-1 Clamp 2
  - K2.0006186 1x Rod Mounting Bracket RMB-3
  - K2.66255.0 1x 15mm Reduction Insert
  - K2.0024114 1x **B-Mount Power Splitting Box**
  - K2.0015896 1x Bottom Dovetail Plate 300mm/12in
  - K2.75007.0 1x Camera Power Cable Straight 2m/6.6in KC50

## Ready to Shoot Set V-Mount

**8x Signature Primes (M) & ALEXA Mini LF Ready to Shoot Set V**, K0.0048024

- includes:
- [KK.0019191](#) ARRI Signature Prime 18/T1.8 **M**
  - [KK.0019196](#) ARRI Signature Prime 25/T1.8 **M**
  - [KK.0019102](#) ARRI Signature Prime 35/T1.8 **M**
  - [KK.0019105](#) ARRI Signature Prime 47/T1.8 **M**
  - [KK.0019203](#) ARRI Signature Prime 58/T1.8 **M**
  - [KK.0019107](#) ARRI Signature Prime 75/T1.8 **M**
  - [KK.0019109](#) ARRI Signature Prime 125/T1.8 **M**
  - [KK.0019210](#) ARRI Signature Prime 200/T2.5 **M**
  - K1.0024074 1x ALEXA Mini LF camera body
  - K2.0018983 1x ARRI LPL Mount (LBUS)
  - [K2.0016936](#) 1x ARRI PL-to-LPL Adapter
  - K2.0024130 2x CODEX Compact Drive 1TB (CA08-1024)
  - K2.0020916 1x Multi Viewfinder MVF-2
  - K2.0023915 1x Cable VF (0.35m/1.15ft)
  - K2.0023943 1x Cable VF (0.5m/1.5ft)
  - K2.0023839 1x Mini Adapter Plate MAP-2A
  - K2.0006140 1x Mini Viewfinder Bracket MVB-1
  - K2.73002.0 1x Center Camera Handle CCH-2
  - K2.0023546 1x Mini Side Bracket MSB-3
  - K2.0014957 1x Mini Side Bracket MSB-2
  - K2.0014894 1x Compact Bridge Plate CBP-1 **19mm**
  - K2.0013937 1x Rear Accessory Bracket RAB-1
  - K2.0023406 1x RAB-1 Clamp 2
  - K2.0006186 1x Rod Mounting Bracket RMB-3
  - K2.66255.0 1x 15mm Reduction Insert
  - K2.0014530 1x **V-Mount Power Splitting Box MkII**
  - K2.0015896 1x Bottom Dovetail Plate 300mm/12in
  - K2.75007.0 1x Camera Power Cable Straight 2m/6.6in KC-50

## Ready to Shoot Set Gold-Mount

**8x Signature Primes (M) & ALEXA Mini LF Ready to Shoot Set Gold**, K0.0048023

- includes:
- [KK.0019191](#) ARRI Signature Prime 18/T1.8 **M**
  - [KK.0019196](#) ARRI Signature Prime 25/T1.8 **M**
  - [KK.0019102](#) ARRI Signature Prime 35/T1.8 **M**
  - [KK.0019105](#) ARRI Signature Prime 47/T1.8 **M**
  - [KK.0019203](#) ARRI Signature Prime 58/T1.8 **M**
  - [KK.0019107](#) ARRI Signature Prime 75/T1.8 **M**
  - [KK.0019109](#) ARRI Signature Prime 125/T1.8 **M**
  - [KK.0019210](#) ARRI Signature Prime 200/T2.5 **M**
  - K1.0024074 1x ALEXA Mini LF camera body
  - K2.0018983 1x ARRI LPL Mount (LBUS)
  - [K2.0016936](#) 1x ARRI PL-to-LPL Adapter
  - K2.0024130 2x CODEX Compact Drive 1TB (CA08-1024)
  - K2.0020916 1x Multi Viewfinder MVF-2
  - K2.0023915 1x Cable VF (0.35m/1.15ft)
  - K2.0023943 1x Cable VF (0.5m/1.5ft)
  - K2.0023839 1x Mini Adapter Plate MAP-2A
  - K2.0006140 1x Mini Viewfinder Bracket MVB-1
  - K2.73002.0 1x Center Camera Handle CCH-2
  - K2.0023546 1x Mini Side Bracket MSB-3
  - K2.0014957 1x Mini Side Bracket MSB-2
  - K2.0014894 1x Compact Bridge Plate CBP-1 **19mm**
  - K2.0013937 1x Rear Accessory Bracket RAB-1
  - K2.0023406 1x RAB-1 Clamp 2
  - K2.0006186 1x Rod Mounting Bracket RMB-3
  - K2.66255.0 1x 15mm Reduction Insert
  - K2.0014532 1x **Gold Mount Power Splitting Box Mk II**
  - K2.0015896 1x Bottom Dovetail Plate 300mm/12in
  - K2.75007.0 1x Camera Power Cable Straight 2m/6.6in KC-50

## ALEXA Mini LF Ready to Shoot Set



**8x Signature Primes (F) & ALEXA Mini LF Ready to Shoot Set B**, K0.0048017

- includes:
- [KK.0019189](#) ARRI Signature Prime 18/T1.8 **F**
  - [KK.0019194](#) ARRI Signature Prime 25/T1.8 **F**
  - [KK.0019099](#) ARRI Signature Prime 35/T1.8 **F**
  - [KK.0019104](#) ARRI Signature Prime 47/T1.8 **F**
  - [KK.0019202](#) ARRI Signature Prime 58/T1.8 **F**
  - [KK.0019106](#) ARRI Signature Prime 75/T1.8 **F**
  - [KK.0019108](#) ARRI Signature Prime 125/T1.8 **F**
  - [KK.0019209](#) ARRI Signature Prime 200/T2.5 **F**
  - K1.0024074 1x ALEXA Mini LF camera body
  - K2.0018983 1x ARRI LPL Mount (LBUS)
  - [K2.0016936](#) 1x ARRI PL-to-LPL Adapter
  - K2.0024130 2x CODEX Compact Drive 1TB (CA08-1024)
  - K2.0020916 1x Multi Viewfinder MVF-2
  - K2.0023915 1x Cable VF (0.35m/1.15ft)
  - K2.0023943 1x Cable VF (0.5m/1.5ft)
  - K2.0023839 1x Mini Adapter Plate MAP-2A
  - K2.0006140 1x Mini Viewfinder Bracket MVB-1
  - K2.73002.0 1x Center Camera Handle CCH-2
  - K2.0023546 1x Mini Side Bracket MSB-3
  - K2.0014957 1x Mini Side Bracket MSB-2
  - K2.0014894 1x Compact Bridge Plate CBP-1 **19mm**
  - K2.0013937 1x Rear Accessory Bracket RAB-1
  - K2.0023406 1x RAB-1 Clamp 2
  - K2.0006186 1x Rod Mounting Bracket RMB-3
  - K2.66255.0 1x 15mm Reduction Insert
  - K2.0024114 1x **B-Mount Power Splitting Box**
  - K2.0015896 1x Bottom Dovetail Plate 300mm/12in
  - K2.75007.0 1x Camera Power Cable Straight 2m/6.6in KC-50

**8x Signature Primes (F) & ALEXA Mini LF Ready to Shoot Set V**, K0.0048019

- includes:
- [KK.0019189](#) ARRI Signature Prime 18/T1.8 **F**
  - [KK.0019194](#) ARRI Signature Prime 25/T1.8 **F**
  - [KK.0019099](#) ARRI Signature Prime 35/T1.8 **F**
  - [KK.0019104](#) ARRI Signature Prime 47/T1.8 **F**
  - [KK.0019202](#) ARRI Signature Prime 58/T1.8 **F**
  - [KK.0019106](#) ARRI Signature Prime 75/T1.8 **F**
  - [KK.0019108](#) ARRI Signature Prime 125/T1.8 **F**
  - [KK.0019209](#) ARRI Signature Prime 200/T2.5 **F**
  - K1.0024074 1x ALEXA Mini LF camera body
  - K2.0018983 1x ARRI LPL Mount (LBUS)
  - [K2.0016936](#) 1x ARRI PL-to-LPL Adapter
  - K2.0024130 2x CODEX Compact Drive 1TB (CA08-1024)
  - K2.0020916 1x Multi Viewfinder MVF-2
  - K2.0023915 1x Cable VF (0.35m/1.15ft)
  - K2.0023943 1x Cable VF (0.5m/1.5ft)
  - K2.0023839 1x Mini Adapter Plate MAP-2A
  - K2.0006140 1x Mini Viewfinder Bracket MVB-1
  - K2.73002.0 1x Center Camera Handle CCH-2
  - K2.0023546 1x Mini Side Bracket MSB-3
  - K2.0014957 1x Mini Side Bracket MSB-2
  - K2.0014894 1x Compact Bridge Plate CBP-1 **19mm**
  - K2.0013937 1x Rear Accessory Bracket RAB-1
  - K2.0023406 1x RAB-1 Clamp 2
  - K2.0006186 1x Rod Mounting Bracket RMB-3
  - K2.66255.0 1x 15mm Reduction Insert
  - K2.0014530 1x **V-Mount Power Splitting Box MkII**
  - K2.0015896 1x Bottom Dovetail Plate 300mm/12in
  - K2.75007.0 1x Camera Power Cable Straight 2m/6.6in KC-50

**8x Signature Primes (F) & ALEXA Mini LF Ready to Shoot Set Gold** K0.0048018

- includes:
- [KK.0019189](#) ARRI Signature Prime 18/T1.8 **F**
  - [KK.0019194](#) ARRI Signature Prime 25/T1.8 **F**
  - [KK.0019099](#) ARRI Signature Prime 35/T1.8 **F**
  - [KK.0019104](#) ARRI Signature Prime 47/T1.8 **F**
  - [KK.0019202](#) ARRI Signature Prime 58/T1.8 **F**
  - [KK.0019106](#) ARRI Signature Prime 75/T1.8 **F**
  - [KK.0019108](#) ARRI Signature Prime 125/T1.8 **F**
  - [KK.0019209](#) ARRI Signature Prime 200/T2.5 **F**
  - K1.0024074 1x ALEXA Mini LF camera body
  - K2.0018983 1x ARRI LPL Mount (LBUS)
  - [K2.0016936](#) 1x ARRI PL-to-LPL Adapter
  - K2.0024130 2x CODEX Compact Drive 1TB (CA08-1024)
  - K2.0020916 1x Multi Viewfinder MVF-2
  - K2.0023915 1x Cable VF (0.35m/1.15ft)
  - K2.0023943 1x Cable VF (0.5m/1.5ft)
  - K2.0023839 1x Mini Adapter Plate MAP-2A
  - K2.0006140 1x Mini Viewfinder Bracket MVB-1
  - K2.73002.0 1x Center Camera Handle CCH-2
  - K2.0023546 1x Mini Side Bracket MSB-3
  - K2.0014957 1x Mini Side Bracket MSB-2
  - K2.0014894 1x Compact Bridge Plate CBP-1 **19mm**
  - K2.0013937 1x Rear Accessory Bracket RAB-1
  - K2.0023406 1x RAB-1 Clamp 2
  - K2.0006186 1x Rod Mounting Bracket RMB-3
  - K2.66255.0 1x 15mm Reduction Insert
  - K2.0014532 1x **Gold Mount Power Splitting Box Mk II**
  - K2.0015896 1x Bottom Dovetail Plate 300mm/12in
  - K2.75007.0 1x Camera Power Cable Straight 2m/6.6in KC-50

### ARRI Ensō Primes - Core Sets & Kits

Format: Large Format & SUPER 35



#### ARRI Ensō Prime Core Set (M)

**KK.0052482**, includes  
 KK.0049812 1x ARRI Ensō Prime KIT 18, 24, 32 (M)  
 KK.0049814 1x ARRI Ensō Prime KIT 47, 75, 105 (M)  
 KK.0049815 1x ARRI Ensō Vintage Elements KIT  
 (all in 3 cases)

#### ARRI Ensō Prime Core Set (F)

**KK.0052483**, includes  
 KK.0049811 1x ARRI Ensō Prime KIT 18, 24, 32 (F)  
 KK.0049813 1x ARRI Ensō Prime KIT 47, 75, 105 (F)  
 KK.0049815 1x ARRI Ensō Vintage Elements KIT  
 (all in 3 cases)



#### ARRI Ensō Prime Kit 18, 24, 32 (M)

**KK.0049812**, includes:  
 K2.0048083 1x ARRI Ensō Prime 18/T2.1 M  
 K2.0048087 1x ARRI Ensō Prime 24/T2.1 M  
 K2.0048091 1x ARRI Ensō Prime 32/T2.1 M  
 (all in 1 case)  
 only available in the Core Set



#### ARRI Ensō Prime Kit 18, 24, 32 (F)

**KK.0049811**, includes:  
 K2.0048082 1x ARRI Ensō Prime 18/T2.1 F  
 K2.0048086 1x ARRI Ensō Prime 24/T2.1 F  
 K2.0048090 1x ARRI Ensō Prime 32/T2.1 F  
 (all in 1 case)  
 only available in the Core Set

#### ARRI Ensō Prime Kit 47, 75, 105 (M)

**KK.0049814**, includes:  
 K2.0048095 1x ARRI Ensō Prime 47/T2.1 M  
 K2.0048100 1x ARRI Ensō Prime 75/T2.1 M  
 K2.0048102 1x ARRI Ensō Prime 105/T2.1 M  
 (all in 1 case)  
 only available in the Core Set

#### ARRI Ensō Prime Kit 47, 75, 105 (F)

**KK.0049813**, includes:  
 K2.0048094 1x ARRI Ensō Prime 47/T2.1 F  
 K2.0048098 1x ARRI Ensō Prime 75/T2.1 F  
 K2.0048101 1x ARRI Ensō Prime 105/T2.1 F  
 (all in 1 case)  
 only available in the Core Set



#### ARRI Ensō Vintage Elements Kit

**KK.0049815**, includes:  
 ARRI Ensō VE 100P / VE 200P / VE 350P / VE 100N / VE 200N / VE 350N  
 ARRI Ensō Creative Adapter + Retaining Rings  
 ARRI Ensō VE Shim Set  
 Adjustable Torque Screwdriver  
 ARRI Ensō Retaining Ring Tool  
 (all in 1 case)



### Matte Box Checker

Find out which matte box you can use with which ARRI lens to avoid vignetting

### ARRI Ensō Primes

Format: Large Format & SUPER 35



**10.5 mm**  
 T2.8 | Ø 156 mm,  
 Ø 134 mm  
[KK.0053511](#) (m)  
[KK.0053510](#) (ft)  
 incl. single case

**14 mm**  
 T2.5 | Ø 156 mm,  
 Ø 134 mm  
[KK.0053517](#) (m)  
[KK.0053516](#) (ft)  
 incl. single case

**18 mm**  
 T2.1 | Ø 95 mm  
 K2.0048083 (m)  
 K2.0048082 (ft)  
 only available in  
 the Core Set

**21 mm**  
 T2.1 | Ø 95 mm  
[KK.0053519](#) (m)  
[KK.0053518](#) (ft)  
 incl. single case

**24 mm**  
 T2.1 | Ø 95 mm  
 K2.0048087 (m)  
 K2.0048086 (ft)  
 only available in  
 the Core Set

**28 mm**  
 T2.1 | Ø 95 mm  
[KK.0053521](#) (m)  
[KK.0053520](#) (ft)  
 incl. single case

**32 mm**  
 T2.1 | Ø 95 mm  
 K2.0048091 (m)  
 K2.0048090 (ft)  
 only available in  
 the Core Set



**40 mm**  
 T2.1 | Ø 95 mm  
[KK.0053524](#) (m)  
[KK.0053522](#) (ft)  
 incl. single case

**47 mm**  
 T2.1 | Ø 95 mm  
 K2.0048095 (m)  
 K2.0048094 (ft)  
 only available in  
 the Core Set

**58 mm**  
 T2.1 | Ø 95 mm  
[KK.0053526](#) (m)  
[KK.0053525](#) (ft)  
 incl. single case

**75 mm**  
 T2.1 | Ø 95 mm  
 K2.0048100 (m)  
 K2.0048098 (ft)  
 only available in  
 the Core Set

**105 mm**  
 T2.1 | Ø 95 mm  
 K2.0048102 (m)  
 K2.0048101 (ft)  
 only available in  
 the Core Set

**150 mm**  
 T2.5 | Ø 95 mm  
[KK.0053528](#) (m)  
[KK.0053527](#) (ft)  
 incl. single case

**250 mm**  
 T2.8 | Ø 114 mm  
[KK.0053531](#) (m)  
[KK.0053530](#) (ft)  
 incl. Extender 1.4x  
 and Extender 2.0x  
 incl. single case



**360 mm**  
 (250 mm + ARRI Ensō Extender 1.4X)  
 T4.0 | Ø 114 mm



**500 mm**  
 (250 mm + ARRI Ensō Extender 2.0X)  
 T5.8 | Ø 114 mm

### ARRI Ensō Primes - caps



**ARRI Ensō Prime  
 Front Cap Ø 95 MM**  
 K2.0049798



**ARRI Ensō Prime  
 Front Cap Ø 114 MM**  
 K2.0049799



**ARRI Ensō Prime  
 Front Cap Ø 134 MM**  
 K2.0049800



**ARRI Ensō Prime  
 Front Cap Ø 156 MM**  
 K2.0049801



**ARRI LPL Mount Ensō  
 Rear Cap**  
 K2.0049797

### ARRI Ensō Extender

only compatible and available with Ensō Prime 250 mm



**ARRI Ensō Extender 1.4X**  
 K2.0048107



**ARRI Ensō Extender 2.0X**  
 K2.0048108



**ARRI LPL Mount Ensō  
 Rear Cap**  
 K2.0049797

## Configuration Overview | 3.2.0 / 2025.09

### ARRI Signature Primes

Format: Large Format  
all Signature Primes will be delivered in a case



Magnetic Rear Filter Holder  
[K2.0019522](#)

12 mm T1.8   Ø 134 mm <a href="#">KK.0019185</a> (m) <a href="#">KK.0019183</a> (ft)	15 mm T1.8   Ø 156 mm <a href="#">KK.0019188</a> (m) <a href="#">KK.0019187</a> (ft)	18 mm T1.8   Ø 114 mm <a href="#">KK.0019191</a> (m) <a href="#">KK.0019189</a> (ft)	21 mm T1.8   Ø 114 mm <a href="#">KK.0019193</a> (m) <a href="#">KK.0019192</a> (ft)	25 mm T1.8   Ø 114 mm <a href="#">KK.0019196</a> (m) <a href="#">KK.0019194</a> (ft)	29 mm T1.8   Ø 114 mm <a href="#">KK.0019199</a> (m) <a href="#">KK.0019197</a> (ft)	35 mm T1.8   Ø 114 mm <a href="#">KK.0019102</a> (m) <a href="#">KK.0019099</a> (ft)	40 mm T1.8   Ø 114 mm <a href="#">KK.0019201</a> (m) <a href="#">KK.0019200</a> (ft)	47 mm T1.8   Ø 114 mm <a href="#">KK.0019105</a> (m) <a href="#">KK.0019104</a> (ft)	58 mm T1.8   Ø 114 mm <a href="#">KK.0019203</a> (m) <a href="#">KK.0019202</a> (ft)	75 mm T1.8   Ø 114 mm <a href="#">KK.0019107</a> (m) <a href="#">KK.0019106</a> (ft)	95 mm T1.8   Ø 114 mm <a href="#">KK.0019205</a> (m) <a href="#">KK.0019204</a> (ft)	125 mm T1.8   Ø 114 mm <a href="#">KK.0019109</a> (m) <a href="#">KK.0019108</a> (ft)	150 mm T1.8   Ø 114 mm <a href="#">KK.0019207</a> (m) <a href="#">KK.0019206</a> (ft)	200 mm T2.5   Ø 114 mm <a href="#">KK.0019210</a> (m) <a href="#">KK.0019209</a> (ft)	280 mm T2.8   Ø 134 mm <a href="#">KK.0019213</a> (m) <a href="#">KK.0019211</a> (ft)

### ARRI/ZEISS Master Prime Lenses

Format: SUPER 35

12 mm T1.3   Ø 156 mm <a href="#">K2.47618.0</a> (m) <a href="#">K2.47718.0</a> (ft)	14 mm T1.3   Ø 114 mm <a href="#">K2.47615.0</a> (m) <a href="#">K2.47715.0</a> (ft)	16 mm T1.3   Ø 114 mm <a href="#">K2.47600.0</a> (m) <a href="#">K2.47700.0</a> (ft)	18 mm T1.3   Ø 114 mm <a href="#">K2.47601.0</a> (m) <a href="#">K2.47701.0</a> (ft)	21 mm T1.3   Ø 114 mm <a href="#">K2.47602.0</a> (m) <a href="#">K2.47702.0</a> (ft)	25 mm T1.3   Ø 114 mm <a href="#">K2.47603.0</a> (m) <a href="#">K2.47703.0</a> (ft)	27 mm T1.3   Ø 114 mm <a href="#">K2.47604.0</a> (m) <a href="#">K2.47704.0</a> (ft)	32 mm T1.3   Ø 114 mm <a href="#">K2.47605.0</a> (m) <a href="#">K2.47705.0</a> (ft)	35 mm T1.3   Ø 114 mm <a href="#">K2.47606.0</a> (m) <a href="#">K2.47706.0</a> (ft)	40 mm T1.3   Ø 114 mm <a href="#">K2.47607.0</a> (m) <a href="#">K2.47707.0</a> (ft)	50 mm T1.3   Ø 114 mm <a href="#">K2.47608.0</a> (m) <a href="#">K2.47708.0</a> (ft)	65 mm T1.3   Ø 114 mm <a href="#">K2.47609.0</a> (m) <a href="#">K2.47709.0</a> (ft)	75 mm T1.3   Ø 114 mm <a href="#">K2.47610.0</a> (m) <a href="#">K2.47710.0</a> (ft)	100 mm T1.3   Ø 114 mm <a href="#">K2.47611.0</a> (m) <a href="#">K2.47711.0</a> (ft)	135 mm T1.3   Ø 114 mm <a href="#">K2.47619.0</a> (m) <a href="#">K2.47719.0</a> (ft)	150 mm T1.3   Ø 134 mm <a href="#">K2.47616.0</a> (m) <a href="#">K2.47716.0</a> (ft)

### ARRI/ZEISS Ultra Prime Lenses \*

Format: SUPER 35

8 mm R T2.8   Ø 134 mm <a href="#">K2.47613.0</a> (m) <a href="#">K2.47612.0</a> (ft)	12 mm T2.0   Ø 156 mm <a href="#">K2.47378.0</a> (m) <a href="#">K2.47380.0</a> (ft)	14 mm T1.9   Ø 114 mm <a href="#">K2.47311.0</a> (m) <a href="#">K2.47323.0</a> (ft)	16 mm T1.9   Ø 95 mm <a href="#">K2.47312.0</a> (m) <a href="#">K2.47324.0</a> (ft)	20 mm T1.9   Ø 95 mm <a href="#">K2.47313.0</a> (m) <a href="#">K2.47325.0</a> (ft)	24 mm T1.9   Ø 95 mm <a href="#">K2.47314.0</a> (m) <a href="#">K2.47326.0</a> (ft)	28 mm T1.9   Ø 95 mm <a href="#">K2.47315.0</a> (m) <a href="#">K2.47327.0</a> (ft)	32 mm T1.9   Ø 95 mm <a href="#">K2.47316.0</a> (m) <a href="#">K2.47328.0</a> (ft)	40 mm T1.9   Ø 95 mm <a href="#">K2.47317.0</a> (m) <a href="#">K2.47329.0</a> (ft)	50 mm T1.9   Ø 95 mm <a href="#">K2.47318.0</a> (m) <a href="#">K2.47330.0</a> (ft)	65 mm T1.9   Ø 95 mm <a href="#">K2.47377.0</a> (m) <a href="#">K2.47379.0</a> (ft)	85 mm T1.9   Ø 95 mm <a href="#">K2.47319.0</a> (m) <a href="#">K2.47331.0</a> (ft)	100 mm T1.9   Ø 95 mm <a href="#">K2.47320.0</a> (m) <a href="#">K2.47332.0</a> (ft)	135 mm T1.9   Ø 95 mm <a href="#">K2.47321.0</a> (m) <a href="#">K2.47333.0</a> (ft)	180 mm T1.9   Ø 114 mm <a href="#">K2.47381.0</a> (m) <a href="#">K2.47382.0</a> (ft)

### ARRI/ZEISS LDS Ultra Prime Lenses \*

Format: SUPER 35

12 mm T2   Ø 156 mm <a href="#">K2.52198.0</a> (m) <a href="#">K2.52199.0</a> (ft)	14 mm T1.9   Ø 114 mm <a href="#">K2.52111.0</a> (m) <a href="#">K2.52123.0</a> (ft)	16 mm T1.9   Ø 104 mm <a href="#">K2.52112.0</a> (m) <a href="#">K2.52124.0</a> (ft)	20 mm T1.9   Ø 104 mm <a href="#">K2.52113.0</a> (m) <a href="#">K2.52125.0</a> (ft)	24 mm T1.9   Ø 104 mm <a href="#">K2.52114.0</a> (m) <a href="#">K2.52126.0</a> (ft)	28 mm T1.9   Ø 104 mm <a href="#">K2.52115.0</a> (m) <a href="#">K2.52127.0</a> (ft)	32 mm T1.9   Ø 104 mm <a href="#">K2.52116.0</a> (m) <a href="#">K2.52128.0</a> (ft)	40 mm T1.9   Ø 104 mm <a href="#">K2.52117.0</a> (m) <a href="#">K2.52129.0</a> (ft)	50 mm T1.9   Ø 104 mm <a href="#">K2.52118.0</a> (m) <a href="#">K2.52130.0</a> (ft)	65 mm T1.9   Ø 104 mm <a href="#">K2.52200.0</a> (m) <a href="#">K2.52201.0</a> (ft)	85 mm T1.9   Ø 104 mm <a href="#">K2.52119.0</a> (m) <a href="#">K2.52131.0</a> (ft)	100 mm T1.9   Ø 104 mm <a href="#">K2.52120.0</a> (m) <a href="#">K2.52132.0</a> (ft)	135 mm T1.9   Ø 104 mm <a href="#">K2.52121.0</a> (m) <a href="#">K2.52133.0</a> (ft)	180 mm T1.9   Ø 114 mm <a href="#">K2.52202.0</a> (m) <a href="#">K2.52203.0</a> (ft)

### ARRI/ZEISS Ultra 16 Lenses \*

Format: SUPER 16

6 mm T1.3   Ø 95 mm <a href="#">K2.47560.0</a> (m) <a href="#">K2.47565.0</a> (ft)	8 mm T1.3   Ø 95 mm <a href="#">K2.47561.0</a> (m) <a href="#">K2.47566.0</a> (ft)	9.5 mm T1.3   Ø 95 mm <a href="#">K2.47562.0</a> (m) <a href="#">K2.47567.0</a> (ft)	12 mm T1.3   Ø 95 mm <a href="#">K2.47563.0</a> (m) <a href="#">K2.47568.0</a> (ft)	14 mm T1.3   Ø 95 mm <a href="#">K2.47564.0</a> (m) <a href="#">K2.47569.0</a> (ft)	18 mm T1.3   Ø 95 mm <a href="#">K2.47580.0</a> (m) <a href="#">K2.47584.0</a> (ft)	25 mm T1.3   Ø 95 mm <a href="#">K2.47581.0</a> (m) <a href="#">K2.47585.0</a> (ft)	35 mm T1.3   Ø 95 mm <a href="#">K2.47582.0</a> (m) <a href="#">K2.47586.0</a> (ft)	50 mm T1.3   Ø 95 mm <a href="#">K2.47583.0</a> (m) <a href="#">K2.47587.0</a> (ft)

### ARRI/ZEISS Macro

Format: SUPER 35



100 mm, T2.0 | Ø 114 mm  
[K2.47572.0](#) (m), [K2.47573.0](#) (ft)

### SP Lens Caps

ARRI LPL Mount Lens Rear Cap Extended, [K2.0020097](#)  
ARRI Signature Prime Front Cap Ø 156mm, [K2.0019316](#)  
ARRI Signature Prime Front Cap Ø 134mm, [K2.0019314](#)  
ARRI Signature Prime Front Cap Ø 114mm, [K2.0019308](#)

\* discontinued items

## Configuration Overview | 3.3.0 / 2025.01

### ARRI/ZEISS Master Anamorphic Lenses

Format: SUPER 35

<b>28 mm</b> T1.9   Ø 114 mm <a href="#">K2.0010083</a> (m) <a href="#">K2.0010082</a> (ft)	<b>35 mm</b> T1.9   Ø 95 mm <a href="#">K2.47957.0</a> (m) <a href="#">K2.47942.0</a> (ft)	<b>40 mm</b> T1.9   Ø 95 mm <a href="#">K2.47958.0</a> (m) <a href="#">K2.47943.0</a> (ft)	<b>50 mm</b> T1.9   Ø 95 mm <a href="#">K2.47959.0</a> (m) <a href="#">K2.47944.0</a> (ft)	<b>60 mm</b> T1.9   Ø 95 mm <a href="#">K2.47960.0</a> (m) <a href="#">K2.47945.0</a> (ft)	<b>75 mm</b> T1.9   Ø 95 mm <a href="#">K2.47961.0</a> (m) <a href="#">K2.47946.0</a> (ft)	<b>100 mm</b> T1.9   Ø 95 mm <a href="#">K2.47962.0</a> (m) <a href="#">K2.47947.0</a> (ft)	<b>135 mm</b> T1.9   Ø 95 mm <a href="#">K2.47963.0</a> (m) <a href="#">K2.47948.0</a> (ft)	<b>180 mm</b> T2.8   Ø 95 mm <a href="#">K2.0010085</a> (m) <a href="#">K2.0010084</a> (ft)

### ARRI/ZEISS Master Anamorphic Flare Sets

no picture available yet	no picture available yet	no picture available yet		no picture available yet	no picture available yet	no picture available yet	no picture available yet	no picture available yet	no picture available yet	no picture available yet
<b>28 mm</b> T1.9   Ø 95 mm <a href="#">K2.0012679</a>	<b>35 mm</b> T1.9   Ø 95 mm <a href="#">K2.0006796</a>	<b>40 mm</b> T1.9   Ø 95 mm <a href="#">K2.0006798</a>	<b>50 mm</b> T1.9   Ø 95 mm <a href="#">K2.0006799</a>	<b>60 mm</b> T1.9   Ø 95 mm <a href="#">K2.0006800</a>	<b>75 mm</b> T1.9   Ø 95 mm <a href="#">K2.0006801</a>	<b>100 mm</b> T1.9   Ø 95 mm <a href="#">K2.0006802</a>	<b>135 mm</b> T1.9   Ø 95 mm <a href="#">K2.0006803</a>	<b>180 mm</b> T1.9   Ø 95 mm <a href="#">K2.0014729</a>	<b>MA Toolkit for Flare Set</b> <a href="#">K2.0006794</a>	

### ARRI Ultra Wide Zoom Lens

Format: SUPER 35 extended



**Ultra Wide Zoom 9.5-18 mm**  
T2.9 | Ø 134 mm & 156 mm  
[K2.47620.0](#) (m), [K2.0001686](#) (ft)

### ARRI Anamorphic Ultra Wide Zoom Lens



**Ultra Wide Zoom 19-36 mm**  
T4.2 | Ø 114 mm  
[K2.0006969](#) (m), [K2.0006968](#) (ft)

### ARRI/FUJINON ALURA Studio Zoom Lenses\*

Format: SUPER 35, spherical

\* discontinued items



**ALURA ZOOM 18-80 mm**  
T2.6 | Ø 134 mm  
[K2.47930.0](#) (m),  
[K2.47931.0](#) (ft)



**ALURA ZOOM 45-250 mm**  
T2.6 | Ø 134 mm  
[K2.47932.0](#) (m),  
[K2.47933.0](#) (ft)

### ARRI/FUJINON ALURA LWZ Zoom Lenses\*

Format: SUPER 35m, spherical

\* discontinued items



**ALURA LWZ ZOOM 15.5-45 mm**  
T2.8 | Ø 114 mm  
[K2.47934.0](#) (m), [K2.47935.0](#) (ft)



**ALURA LWZ ZOOM 30-80 mm**  
T2.8 | Ø 114 mm  
[K2.47936.0](#) (m), [K2.47937.0](#) (ft)

### ARRI/FUJINON LDS Extender \*

\* discontinued items



**ALURA LDS Extender 1.4x (ALE1.4x)**  
[K2.47926.0](#)  
**ALURA LDS Extender 2.0x (ALE2.0x)**  
[K2.47927.0](#)

Alura Zoom	+	Alura Extender	=	Resulting combination
Alura 15.5-45 / T2.8	+	Alura LDS Extender 1.4x	=	Alura 22-63 / T4.0
Alura 15.5-45 / T2.8	+	Alura LDS Extender 2.0x	=	Alura 31-90 / T5.6
Alura 30-80 / T2.8	+	Alura LDS Extender 1.4x	=	Alura 42-112 / T4.0
Alura 30-80 / T2.8	+	Alura LDS Extender 2.0x	=	Alura 60-160 / T5.6
Alura 18-80 / T2.6	+	Alura LDS Extender 1.4x	=	Alura 25-112 / T3.7
Alura 18-80 / T2.6	+	Alura LDS Extender 2.0x	=	Alura 25-112 / T5.2
Alura 45-250 / T2.6	+	Alura LDS Extender 1.4x	=	Alura 63-350 / T3.7
Alura 45-250 / T2.6	+	Alura LDS Extender 2.0x	=	Alura 90-500 / T5.2

## ARRI Impression V Filter

for Signature Primes and Signature Zoom Lenses

### ARRI Impression V Filter Kit

- [KK.0048312](#), includes:  
 1x ARRI Impression V Aluminum Case  
 1x ARRI Impression V Filter 070P  
 1x ARRI Impression V Filter 140P  
 1x ARRI Impression V Filter 230P  
 1x ARRI Impression V Filter 330P  
 1x ARRI Impression V Filter 050N  
 1x ARRI Impression V Filter 100N  
 1x ARRI Impression V Filter 200N  
 1x ARRI Impression V Filter 290N  
 1x ARRI Impression V Shim Set  
 1x ARRI Impression V Velcro® Set  
 1x Torque Screwdriver



### ARRI Impression V 050N Filter Pack, [K2.0048143](#)

- Includes:  
 3x ARRI Impression V Filter 050N  
 1x ARRI Impression V Shim Set  
 2x ARRI Impression V Velcro® Set

### ARRI Impression V 100N Filter Pack, [K2.0048144](#)

- Includes:  
 3x ARRI Impression V Filter 100N  
 1x ARRI Impression V Shim Set  
 2x ARRI Impression V Velcro® Set

### ARRI Impression V 200N Filter Pack, [K2.0048145](#)

- Includes:  
 3x ARRI Impression V Filter 200N  
 1x ARRI Impression V Shim Set  
 2x ARRI Impression V Velcro® Set

### ARRI Impression V 290N Filter Pack, [K2.0048146](#)

- Includes:  
 3x ARRI Impression V Filter 290N  
 1x ARRI Impression V Shim Set  
 2x ARRI Impression V Velcro® Set



### ARRI Impression V 070P Filter Pack, [K2.0048139](#)

- Includes:  
 3x ARRI Impression V Filter 070P  
 3x ARRI Impression V Velcro® Set

### ARRI Impression V 140P Filter Pack, [K2.0048140](#)

- Includes:  
 3x ARRI Impression V Filter 140P  
 3x ARRI Impression V Velcro® Set

### ARRI Impression V 230P Filter Pack, [K2.0048141](#)

- Includes:  
 3x ARRI Impression V Filter 230P  
 3x ARRI Impression V Velcro® Set

### ARRI Impression V 330P Filter Pack, [K2.0048142](#)

- Includes:  
 3x ARRI Impression V Filter 330P  
 3x ARRI Impression V Velcro® Set

### ARRI Impression V Shim Pack, [K2.0048147](#)

- Includes:  
 6x ARRI Impression V Shim Set

### ARRI Impression V Velcro® Pack, [K2.0048148](#)

- Includes:  
 6x ARRI Impression V Velcro® Set

## ALEXA LPL LF FSND Filters

manual in-camera filters:  
 have to be inserted/removed by hand in contrast to the internal motorized FSND filters for ALEXA Mini, ALEXA Mini LF & Amira

### ALEXA LPL LF FSND Filter Set, Full

- K2.0018790, includes:  
 K4.0015593 1x ALEXA LPL LF IFM Optical Clear  
 K4.0015594 1x ALEXA LPL LF FSND 0.3  
 K4.0015595 1x ALEXA LPL LF FSND 0.6  
 K4.0015596 1x ALEXA LPL LF FSND 0.9  
 K4.0015597 1x ALEXA LPL LF FSND 1.2  
 K4.0015598 1x ALEXA LPL LF FSND 1.5  
 K4.0015599 1x ALEXA LPL LF FSND 1.8  
 K4.0015600 1x ALEXA LPL LF FSND 2.1  
 K4.0015601 1x ALEXA LPL LF FSND 2.4  
 K2.72144.0 1x IFM/Extenders Depth Gauge DG-1  
 K4.0007655 1x ALEXA LF FSND Filter Case  
 K4.0007656 1x ALEXA FSND Filter Insertion Tool  
 K2.0019021 1x ALEXA LPL LF IFM Shim



## ARRI FSND Matte Box Filters

### ARRI FSND Filter Basic Set 6.6"x6.6"

- [KK.0019785](#), includes:  
[K2.0013892](#) 1x ARRI FSND 0.3 Filter 6.6" x 6.6"  
[K2.0013894](#) 1x ARRI FSND 0.6 Filter 6.6" x 6.6"  
[K2.0013896](#) 1x ARRI FSND 0.9 Filter 6.6" x 6.6"  
[K2.0016922](#) 1x Optical Cleaning Cloth 14.6" x 17.7"



### ARRI FSND Filter Pro Set 6.6"x6.6"

- [KK.0019797](#), includes:  
[K2.0013892](#) 1x ARRI FSND 0.3 Filter 6.6" x 6.6"  
[K2.0013894](#) 1x ARRI FSND 0.6 Filter 6.6" x 6.6"  
[K2.0013896](#) 1x ARRI FSND 0.9 Filter 6.6" x 6.6"  
[K2.0013998](#) 1x ARRI FSND 1.2 Filter 6.6" x 6.6"  
[K2.0013900](#) 1x ARRI FSND 1.5 Filter 6.6" x 6.6"  
[K2.0013902](#) 1x ARRI FSND 1.8 Filter 6.6" x 6.6"  
[K2.0013905](#) 1x ARRI FSND 2.1 Filter 6.6" x 6.6"  
 K2.0013906 1x ARRI FSND 2.4 Filter 6.6" x 6.6"  
[K2.0016922](#) 1x Optical Cleaning Cloth 14.6" x 17.7"

### ARRI FSND Filter Basic Set 4"x5.56"

- [KK.0019784](#), includes:  
[K2.0013887](#) 1x ARRI FSND 0.3 Filter 4" x 5.65"  
[K2.0013901](#) 1x ARRI FSND 0.6 Filter 4" x 5.65"  
[K2.0013895](#) 1x ARRI FSND 0.9 Filter 4" x 5.65"  
[K2.0016922](#) 1x Optical Cleaning Cloth 14.6" x 17.7"

### ARRI FSND Filter Pro Set 4"x5.65"

- [KK.0019789](#), includes:  
[K2.0013887](#) 1x ARRI FSND 0.3 Filter 4" x 5.65"  
[K2.0013901](#) 1x ARRI FSND 0.6 Filter 4" x 5.65"  
[K2.0013895](#) 1x ARRI FSND 0.9 Filter 4" x 5.65"  
[K2.0013904](#) 1x ARRI FSND 1.2 Filter 4" x 5.65"  
[K2.0013897](#) 1x ARRI FSND 1.5 Filter 4" x 5.65"  
[K2.0013890](#) 1x ARRI FSND 1.8 Filter 4" x 5.65"  
[K2.0013903](#) 1x ARRI FSND 2.1 Filter 4" x 5.65"  
[K2.0013891](#) 1x ARRI FSND 2.4 Filter 4" x 5.65"  
[K2.0016922](#) 1x Optical Cleaning Cloth 14.6" x 17.7"

## ARRI ALEXA PL S35 FSND Filters



### ARRI Ensō Vintage Elements Kit

- [KK.0049815](#), includes:  
 ARRI Ensō VE 100P / VE 200P / VE 350P / VE 100N / VE 200N / VE 350N  
 ARRI Ensō Creative Adapter + Retaining Rings  
 ARRI Ensō VE Shim Set  
 Adjustable Torque Screwdriver  
 ARRI Ensō Retaining Ring Tool  
 (all in 1 case)  
 currently only available in the Ensō Core Sets [K0.0052482](#) and [K0.0052483](#)

## ARRI ALEXA PL S35 FSND Filters

manual in-camera filters:  
 have to be inserted/removed by hand in contrast to the internal motorized FSND filters for ALEXA Mini, ALEXA Mini LF & Amira

The content of the Basic set combined with the content of the Completion set equals the content of the Full set.



### ALEXA PL S35 FSND Filter Set, Full

- K2.72139.0, includes:  
 K4.73069.0 1x ALEXA PL S35 FSND 0.3  
 K4.73070.0 1x ALEXA PL S35 FSND 0.6  
 K4.73071.0 1x ALEXA PL S35 FSND 0.9  
 K4.73072.0 1x ALEXA PL S35 FSND 1.2  
 K4.73073.0 1x ALEXA PL S35 FSND 1.5  
 K4.73074.0 1x ALEXA PL S35 FSND 1.8  
 K4.73075.0 1x ALEXA PL S35 FSND 2.1  
 K4.73076.0 1x ALEXA PL S35 FSND 2.4  
 K4.73062.0 1x ALEXA PL S35 IFM Optical Clear  
 K2.72143.0 1x ALEXA PL S35 IFM Shim  
 K4.52722.0 1x Ground Glass/Frameglow tool  
 K2.72144.0 1x IFM/Extenders Depth Gauge DG-1  
 K4.73081.0 1x Case

### ALEXA PL S35 FSND Filter Set, Completion

- K2.72138.0, includes:  
 K4.73069.0 1x ALEXA PL S35 FSND 0.3  
 K4.73071.0 1x ALEXA PL S35 FSND 0.9  
 K4.73073.0 1x ALEXA PL S35 FSND 1.5  
 K4.73075.0 1x ALEXA PL S35 FSND 2.1  
 K4.73076.0 1x ALEXA PL S35 FSND 2.4

### ALEXA PL S35 FSND Filter Set, Basic

- K2.72137.0, includes:  
 K4.73070.0 1x ALEXA PL S35 FSND 0.6  
 K4.73072.0 1x ALEXA PL S35 FSND 1.2  
 K4.73074.0 1x ALEXA PL S35 FSND 1.8  
 K4.73062.0 1x ALEXA PL S35 IFM Optical Clear  
 K2.72143.0 1x ALEXA PL S35 IFM Shim  
 K4.52722.0 1x Ground Glass/Frameglow tool  
 K2.72144.0 1x IFM/Extenders Depth Gauge DG-1  
 K4.73081.0 1x Case

## Cinefade Vari360



### cmotion Cinefade Vari360

- [KK.0053991](#)  
 includes:  
 1x Static Polariser  
 1x Motorized Polariser  
 1x 3/8" mounting point for safety loop  
 1x cmotion Cinefade Vari360 hard case

for add. recommended products please see price list:

Hi-5 Hand Unit:  
 Cinefade License Key for Hi-5, [10.0040586](#)

Cable LBUS (angled) - LBUS (straight) (0.35m/1.15ft), [K2.0013042](#)  
 Cable LBUS - D-Tap (0.8m/2.6ft) [K2.0006758](#)

## Rota Pola



Rota Pola Filter Frame 4x5.65  
[K2.0009434](#)



Rota Pola Filter Frame 6.6x6.6  
[K2.0017086](#)

## Hi-5 & RIA incl. Accessories

For more details please see specific Configuration Overviews for Hi-5 and RIA-1



### Hi-5 Hand Unit Body Kit, [KK.0039973](#)

Includes:  
 K2.0037280 1x Hi-5 Hand Unit Body Naked  
[K2.0039838](#) 1x Bluetooth Dongle  
[K2.0037463](#) 1x Smart Focus Ring Blank

### Hi-5 Hand Unit Basic Set w/o Batteries, Charger, [KK.0042529](#)

Includes:  
[KK.0039973](#) 1x Hi-5 Hand Unit Body Kit  
[K2.0033702](#) 1x RF-EMIP Radio Module 2400 MHz DSSS  
[K2.0039959](#) 1x Hi-5 Neck Strap  
[K2.0039958](#) 1x Hi-5 Hand Strap  
[K2.0040015](#) 1x Hi-5 PanzerGlass

Please note: Batteries and battery charger are not included!



**RF-EMIP Radio Module 2400 MHz DSSS Set (2x), [KK.0039985](#)** (white)  
 includes:  
[K2.0033702](#), RF-EMIP Radio Module 2400 MHz DSSS (2x)



**Radio Interface Adapter RIA-1 Set, [KK.0039980](#)**  
 includes:  
[K2.0036186](#) 1x Radio Interface Adapter RIA-1  
[K2.0039465](#) 1x RIA-1 Bracket

## Hi-5 SX Single Axis Sets



### Hi-5 SX Body Kit, [KK.0051704](#)

Includes:  
 K2.0037280 1x Hi-5 Hand Unit Body Naked  
[K2.0039838](#) 1x Bluetooth Dongle  
[K2.0037463](#) 1x Custom Smart Ring  
 K4.0042707 1x Hi-5 Force-Pad Cover Black

### Hi-5 SX Basic Set w/o Batteries, Charger, [KK.0051705](#)

Includes:  
[KK.0051704](#) 1x Hi-5 SX Body Kit  
[K2.0040015](#) 1x Hi-5 PanzerGlass  
[K2.0039958](#) 1x Hi-5 Hand Strap  
[K2.0039959](#) 1x Hi-5 Neck Strap  
[K2.0033702](#) 1x RF-EMIP Radio Module 2400 MHz DSSS

### Hi-5 SX Basic Set, [KK.0051708](#)

Includes:  
[KK.0051705](#) 1x Hi-5 SX Basic Set w/o Batteries, Charger  
[K2.0036022](#) 2x Li-Ion Battery Pack LBP-3500  
[K2.0039874](#) 1x LBP Battery Charger

### ECS Single Axis Starter Set, [KK.0051713](#)

Includes:  
[KK.0051705](#) 1x Hi-5 SX Basic Set w/o Batteries, Charger  
[K2.0036022](#) 2x Li-Ion Battery Pack LBP-3500  
[K2.0039874](#) 1x LBP Battery Charger  
[KK.0040345](#) 1x **cforce** mini RF Basic Set 2  
[K2.0006758](#) 1x Cable LBUS - D-Tap (0.8m/2.6ft)  
[K2.0015760](#) 1x Cable CAM (7p) - LBUS (0.5m/1.6ft)  
[K2.0015754](#) 1x Cable CAM (7p) - RS (0.3m/1ft)

## Zoom Control

For more details please see specific Configuration Overviews for ZMU-4



### ZMU-4 Basic Set, [KK.0043770](#)

includes:  
[K2.0039926](#) 1x ZMU-4 Zoom Main Unit Body  
[K2.0033702](#) 1x RF-EMIP Radio Module 2400 MHz DSSS  
[K2.0041744](#) 1x Rosette Adapter RA-7  
[K2.0044203](#) 1x Rosette Adapter RA-8  
[K2.0044543](#) 1x ZMU-4 ARRI Rosette



**ZMU-4 Body**  
[K2.0039926](#)



**cmotion steady zoom**  
[K2.0042582](#)  
 LBUS Cables not included



**cmotion pan-bar zoom**  
[K2.0042582](#)  
 LBUS Cables not included

## Motor Controller



**Universal Motor Controller UMC-4 LDS, [K2.0002058](#)**  
 incl. L-Bracket [K2.0001967](#)



**Radio Interface Adapter RIA-1**  
[K2.0036186](#)  
 here shown combined with RF-EMIP 2400 MHz DSSS Radio Module, [K2.0033702](#)

## Operator Control Unit



### Operator Control Unit OCU-1 Extended Set 2 [KK.0040346](#)

includes:  
[K2.0020002](#) 1x Operator Control Unit OCU-1 Basic Set  
[K2.0020003](#) 1x OCU-1 Rosette Bracket  
[K2.0036610](#) 1x **cforce** mini Clamp Console 2 19/15mm



**Operator Control Unit OCU-1 Basic Set, [K2.0020002](#)**



**OCU-1 Rosette Bracket [K2.0020003](#)**



**OCU-1 Dovetail Mounting Interface [K2.0022269](#)**



**CLM-5/cforce mini Clamp Console 19/15mm, [K2.0006176](#)**  
 kompatibel with OCU



**cforce mini Clamp Console 2 19/15mm, [K2.0036610](#)**

## Master Grips



**Master Grip Left Wheel MLW-1**  
[K2.0009363](#)



**Master Grip Right Rocker MRR-1**  
[K2.0009493](#)

further Configurations regarding Master Grips available, starting with Config 4.9.0

## LCUBE converters



**LCUBE - CUB-1 (Basic Set) [KK.0009001](#)**



**LCUBE - CUB-2 (Basic Set) [KK.0013217](#)**



**LCUBE CUB-1 [K2.0008630](#)**

**LCUBE Bracket [K2.0009620](#)**

**LCUBE CUB-2 [K2.0010681](#)**

**LCUBE Bracket [K2.0009620](#)**

**Cable LENS/ENG (12p) - Hi (12p) analog, [K2.0022328](#)**

**LBUS 0.2m/8", [K2.0006749](#)**  
**LBUS 0.3m/1ft, [K2.0006750](#)**  
**LBUS 0.5m/1.5ft, [K2.0006751](#)**  
**LBUS 0.8m/2.5ft, [K2.0006752](#)**  
**LBUS 1.5m/5ft, [K2.0006753](#)**  
**LBUS 3m/10ft, [K2.0006754](#)**  
**LBUS 6m/20ft, [K2.0006755](#)**  
**LBUS 15m/49ft, [K2.0006756](#)**



**LCUBE CUB-1 [K2.0008630](#)**



**LCUBE Bracket [K2.0009620](#)**



**LCUBE CUB-2 [K2.0010681](#)**



**LCUBE Bracket [K2.0009620](#)**



**Cable LENS/ENG (12p) - Hi (12p) analog, [K2.0022328](#)**

**Cable LBUS - D-Tap (1.2m/4ft) [K2.0006757](#)**

**Cable LBUS - RS (0.8m/2.6ft) [K2.0006759](#)**

**Cable LBUS - XLR (4p) (0.8m/2.6ft), [K2.0006760](#)**

# Hi-5 / Hi-5 SX / RIA / Radio Modules - Overview



Configuration Overview | 4.1.0 / 2025.10

## Hi-5 Hand Unit Sets

### Hi-5 Hand Unit Body Kit, [KK.0039973](#)

Includes:  
[K2.0037280](#) 1x Hi-5 Hand Unit Body Naked  
[K2.0039838](#) 1x Bluetooth Dongle  
[K2.0037463](#) 1x Smart Focus Ring Blank

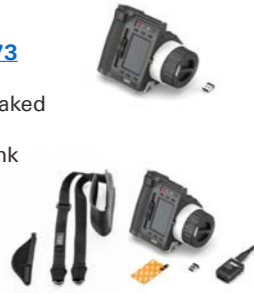

### Hi-5 Hand Unit Basic Set w/o Batteries, Charger, [KK.0042529](#)

Includes:  
[K2.0039973](#) 1x Hi-5 Hand Unit Body Kit  
[K2.0033702](#) 1x RF-EMIP Radio Module 2400 MHz DSSS  
[K2.0039959](#) 1x Hi-5 Neck Strap  
[K2.0039958](#) 1x Hi-5 Hand Strap  
[K2.0040015](#) 1x Hi-5 PanzerGlass



Please note: Batteries and battery charger are not included!



### Hi-5 Hand Unit Basic Set, [KK.0041791](#)

includes:  
[KK.0042529](#) 1x Hi-5 Hand Unit Basic Set w/o Batteries, Charger  
[K2.0039874](#) 1x LBP Battery Charger  
[K2.0036022](#) 2x Li-Ion Battery Pack LBP-3500



### Hi-5 RX-TX 2400 Set, [KK.0041793](#)

Includes:  
[KK.0042529](#) 1x Hi-5 Hand Unit Basic Set w/o Batteries, Charger  
[K2.0039874](#) 1x LBP Battery Charger  
[K2.0036022](#) 3x Li-Ion Battery Pack LBP-3500  
[K2.0037880](#) 1x Hi-5 Monitor Bracket  
[KK.0039980](#) 1x Radio Interface Adapter RIA-1 Set  
[KK.0039984](#) 1x RF-2400 Radio Module 2400 MHz FHSS Set (2x)



### Hi-5 RX-TX 900 Set, [KK.0041792](#)

includes:  
[KK.0042529](#) 1x Hi-5 Hand Unit Basic Set w/o Batteries, Charger  
[K2.0039874](#) 1x LBP Battery Charger  
[K2.0036022](#) 3x Li-Ion Battery Pack LBP-3500  
[K2.0037880](#) 1x Hi-5 Monitor Bracket  
[KK.0039980](#) 1x Radio Interface Adapter RIA-1 Set  
[KK.0039986](#) 1x RF-900 Radio Module 900 MHz FHSS Set (2x)



## Hi-5 SX Single Axis Hand Unit Sets

### Hi-5 SX Body Kit, [KK.0051704](#)

Includes:  
[K2.0037280](#) 1x Hi-5 Hand Unit Body Naked  
[K2.0039838](#) 1x Bluetooth Dongle  
[K2.0037463](#) 1x Custom Smart Ring  
[K4.0042707](#) 1x Hi-5 Force-Pad Cover Black



### Hi-5 SX Basic Set w/o Batteries, Charger, [KK.0051705](#)

Includes:  
[KK.0051704](#) 1x Hi-5 SX Body Kit  
[K2.0040015](#) 1x Hi-5 PanzerGlass  
[K2.0039958](#) 1x Hi-5 Hand Strap  
[K2.0039959](#) 1x Hi-5 Neck Strap  
[K2.0033702](#) 1x RF-EMIP Radio Module 2400 MHz DSSS



### Hi-5 SX Basic Set, [KK.0051708](#)

Includes:  
[KK.0051705](#) 1x Hi-5 SX Basic Set w/o Batteries, Charger  
[K2.0036022](#) 2x Li-Ion Battery Pack LBP-3500  
[K2.0039874](#) 1x LBP Battery Charger



### ECS Single Axis Starter Set, [KK.0051713](#)

Includes:  
[KK.0051705](#) 1x Hi-5 SX Basic Set w/o Batteries, Charger  
[K2.0036022](#) 2x Li-Ion Battery Pack LBP-3500  
[K2.0039874](#) 1x LBP Battery Charger  
[KK.0040345](#) 1x cforce mini RF Basic Set 2  
[K2.0006758](#) 1x Cable LBUS - D-Tap (0.8m/2.6ft)  
[K2.0015760](#) 1x Cable CAM (7p) - LBUS (0.5m/1.6ft)  
[K2.0015754](#) 1x Cable CAM (7p) - RS (0.3m/1ft)



## Single Parts



Hi-5 Hand Unit Body Naked, [K2.0037280](#)



Hi-5 Monitor Bracket [K2.0037880](#)



Hi-5 PanzerGlass [K2.0040015](#)



Li-Ion Battery Pack LBP-3500, [K2.0036022](#)



LBP Battery Charger [K2.0039874](#)



RF-Cover [K2.0039965](#)



Hi-5 Hand Strap [K2.0039958](#)



Hi-5 Neck Strap [K2.0039959](#)



Bluetooth Dongle [K2.0039838](#)

## RIA & Radio Modules



### Radio Interface Adapter RIA-1 Set, [KK.0039980](#)

includes:  
[K2.0036186](#) 1x Radio Interface Adapter RIA-1  
[K2.0039465](#) 1x RIA-1 Bracket



### RF-EMIP Radio Module 2400 MHz DSSS Set (2x), [KK.0039985](#) (white)

includes:  
[K2.0033702](#), RF-EMIP Radio Module 2400 MHz DSSS (2x)



### RF-2400 Radio Module 2400 MHz FHSS Set (2x), [KK.0039984](#) (orange)

includes:  
[K2.0036598](#), RF-2400 Radio Module 2400 MHz FHSS (2x)



### RF-900 Radio Module 900 MHz FHSS Set (2x), [KK.0039986](#) (grey)

includes:  
[K2.0036599](#), RF-900 Radio Module 900 MHz FHSS (2x) (not available yet)



Radio Interface Adapter RIA-1 [K2.0036186](#)



RF-900 Radio Module 900 MHz FHSS, [K2.0036599](#) (grey) (not available yet)



RF-2400 Radio Module 2400 MHz FHSS, [K2.0036598](#) (orange)



RF-EMIP Radio Module 2400 MHz DSSS, [K2.0033702](#) (white)



RIA-1 Bracket [K2.0039465](#)

## License Key



Cinefade License Key for Hi-5, [10.0040586](#)



Focusbug License Key for Hi-5, [10.0040585](#)



Sony Camera Control License Key for Hi-5, [10.0040584](#)



RED Camera Control License Key for Hi-5, [10.0040582](#)



Hi-5 SX Plus License [10.0051711](#)



Hi-5 SX All-Axis License [10.0051712](#)

## Rings for Hi-5 & Hi-5 SX

### Standard Rings



#### Smart Focus Ring Set Meter, [KK.0047821](#)

includes:

- Smart Focus Ring 0.20m, [K2.0040110](#)
- Smart Focus Ring 0.25m, [K2.0040111](#)
- Smart Focus Ring 0.30m, [K2.0040112](#)
- Smart Focus Ring 0.35m, [K2.0040113](#)
- Smart Focus Ring 0.50m, [K2.0040114](#)
- Smart Focus Ring 0.75m, [K2.0040115](#)
- Smart Focus Ring 1.00m, [K2.0040116](#)
- Smart Focus Ring 1.50m, [K2.0040117](#)
- Smart Focus Ring 2.00m, [K2.0040118](#)
- Smart Focus Ring 3.00m, [K2.0040119](#)

#### Smart Focus Ring Set Feet, [KK.0047820](#)

includes:

- Smart Focus Ring 1', [K2.0040121](#)
- Smart Focus Ring 1'3, [K2.0040122](#)
- Smart Focus Ring 1'8, [K2.0040123](#)
- Smart Focus Ring 2', [K2.0040280](#)
- Smart Focus Ring 2'6, [K2.0040124](#)
- Smart Focus Ring 3'6, [K2.0040125](#)
- Smart Focus Ring 5', [K2.0040126](#)
- Smart Focus Ring 6'6, [K2.0040127](#)
- Smart Focus Ring 9", [K2.0040120](#)
- Smart Focus Ring 10', [K2.0040128](#)

#### Hi-5 Custom Smart Ring Set (5x) [KK.0051709](#)

includes:

- 5x Custom Smart Ring, [K2.0037463](#)

Smart Focus Ring Blank, [K2.0037463](#)

### Left Hander Rings



#### Smart Focus Ring Left Hander Set Meter (10x), [KK.0047205](#),

includes:

- Smart Focus Ring Left Hander 0.20m, [K2.0047241](#)
- Smart Focus Ring Left Hander 0.25m, [K2.0047242](#)
- Smart Focus Ring Left Hander 0.30m, [K2.0047243](#)
- Smart Focus Ring Left Hander 0.35m, [K2.0047244](#)
- Smart Focus Ring Left Hander 0.50m, [K2.0047245](#)
- Smart Focus Ring Left Hander 0.75m, [K2.0047246](#)
- Smart Focus Ring Left Hander 1.00m, [K2.0047247](#)
- Smart Focus Ring Left Hander 1.50m, [K2.0047248](#)
- Smart Focus Ring Left Hander 2.00m, [K2.0047249](#)
- Smart Focus Ring Left Hander 3.00m, [K2.0047250](#)

#### Smart Focus Ring Left Hander Set Feet (10x), [KK.0047206](#),

includes:

- Smart Focus Ring Left Hander 9", [K2.0047251](#)
- Smart Focus Ring Left Hander 1', [K2.0047252](#)
- Smart Focus Ring Left Hander 1'3, [K2.0047253](#)
- Smart Focus Ring Left Hander 1'8, [K2.0047254](#)
- Smart Focus Ring Left Hander 2', [K2.0047255](#)
- Smart Focus Ring Left Hander 2'6, [K2.0047256](#)
- Smart Focus Ring Left Hander 3'6, [K2.0047257](#)
- Smart Focus Ring Left Hander 5', [K2.0047258](#)
- Smart Focus Ring Left Hander 6'6, [K2.0047259](#)
- Smart Focus Ring Left Hander 10', [K2.0047260](#)

### Reversed Rings



#### Smart Focus Ring Reverse Set Meter (10x), [KK.0047203](#)

includes:

- Smart Focus Ring Reverse 0.20m, [K2.0047220](#)
- Smart Focus Ring Reverse 0.25m, [K2.0047221](#)
- Smart Focus Ring Reverse 0.30m, [K2.0047222](#)
- Smart Focus Ring Reverse 0.35m, [K2.0047223](#)
- Smart Focus Ring Reverse 0.50m, [K2.0047224](#)
- Smart Focus Ring Reverse 0.75m, [K2.0047225](#)
- Smart Focus Ring Reverse 1.00m, [K2.0047226](#)
- Smart Focus Ring Reverse 1.50m, [K2.0047227](#)
- Smart Focus Ring Reverse 2.00m, [K2.0047228](#)
- Smart Focus Ring Reverse 3.00m, [K2.0047229](#)

#### Smart Focus Ring Reverse Set Feet (10x), [KK.0047204](#)

includes:

- Smart Focus Ring Reverse 9", [K2.0047230](#)
- Smart Focus Ring Reverse 1', [K2.0047231](#)
- Smart Focus Ring Reverse 1'3, [K2.0047232](#)
- Smart Focus Ring Reverse 1'8, [K2.0047233](#)
- Smart Focus Ring Reverse 2', [K2.0047234](#)
- Smart Focus Ring Reverse 2'6, [K2.0047235](#)
- Smart Focus Ring Reverse 3'6, [K2.0047236](#)
- Smart Focus Ring Reverse 5', [K2.0047237](#)
- Smart Focus Ring Reverse 6'6, [K2.0047238](#)
- Smart Focus Ring Reverse 10', [K2.0047239](#)

### Iris Rings



#### Smart Iris Ring Set (5x), [KK.0047207](#)

includes:

- Smart Iris Ring T1.0-T22, [K2.0047208](#)
- Smart Iris Ring T1.4-T22, [K2.0047209](#)
- Smart Iris Ring T2.0-T22, [K2.0047211](#)
- Smart Iris Ring T2.8-T22, [K2.0047212](#)
- Smart Iris Ring T1.0-Close, [K2.0047213](#)

# Radio Interface Adapter RIA-1 - Configuration Overview



Configuration Overview | 4.1.2 / 2026.04

## RIA-1 Sample Configuration

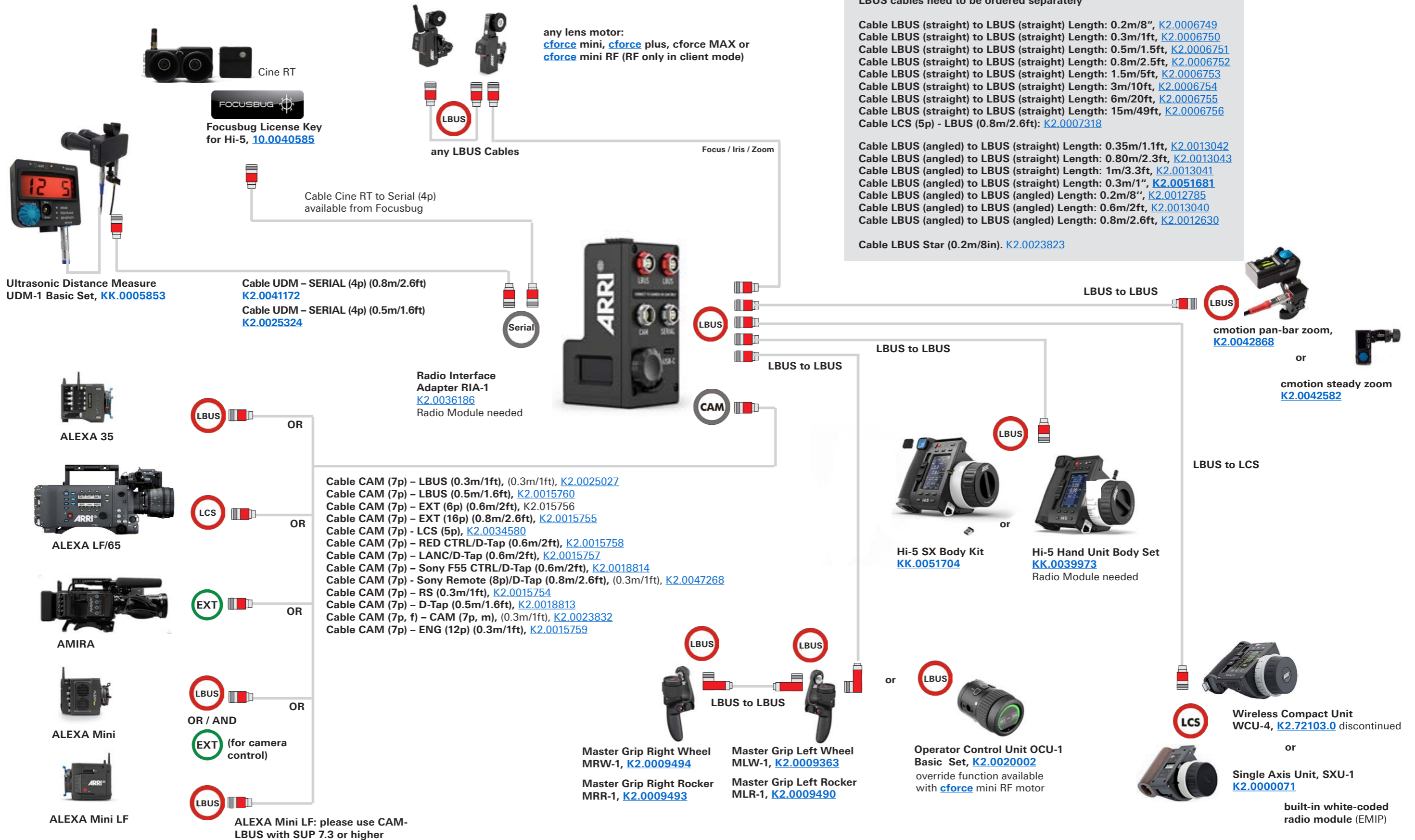

# RIA-1 - Cable Guide



Configuration Overview | 4.1.3 / 2025.10

Item Number	Cable Name	Supported Cameras	Camera Control		
			Run/Stop?	on Hi-5	on WCU-4
<a href="#">K2.0025027</a>	Cable CAM (7p) – LBUS (0.3m/1ft)	ALEXA 35	Yes	Yes	Yes
<a href="#">K2.0015760</a>	Cable CAM (7p) – LBUS (0.5m/1.6ft)	ALEXA 35	Yes	Yes	Yes
<a href="#">K2.0015756</a>	Cable CAM (7p) – EXT (6p) (0.6m/2ft)	ALEXA Mini, ALEXA Mini LF, AMIRA	Yes	Yes	Yes
<a href="#">K2.0015755</a>	Cable CAM (7p) – EXT (16p) (0.8m/2.6ft)	ALEXA Classic EV, ALEXA XT EV, ALEXA SXT EV. Only works with ALEXA EV cameras, not ALEXA Plus	Yes	Yes	Yes
<a href="#">K2.0034580</a>	Cable CAM (7p) - LCS (5p) (0.8m/2.6ft)	ALEXA Plus cameras including ALEXA Plus, ALEXA XT Plus, ALEXA SXT Plus, ALEXA LF, ALEXA 65	Yes	Yes	Yes
<a href="#">K2.0015758</a>	Cable CAM (7p) – RED CTRL/D-Tap (0.6m/2ft)	RED DSMC2 cameras except those with Base Expander Module. RED DSMC3 cameras (Komodo/V-Raptor) with module or break-out cable from 9p Lemo EXT Connector to RED CTRL connector. Supports run/stop/tally on WCU-4 and Hi-5. Additional RED Camera Control License Key required for further camera control on Hi-5	Yes	Yes	No
<a href="#">K2.0015757</a>	Cable CAM (7p) – LANC/D-Tap (0.6m/2ft)	Many cameras with a LANC connector including Canon C300/C500 series, Sony PXW-FX9/FS7 and Blackmagic Ursa Mini Pro	Yes	No	No
<a href="#">K2.0018814</a>	Cable CAM (7p) – Sony Venice/F55 CTRL/D-Tap (0.6m/2ft)	Sony F5/F55 and Sony Venice. Not compatible with Sony Venice 2, Panasonic Varicam, Panasonic Varicam LT	Yes	No	No
<a href="#">K2.0047268</a>	Cable CAM (7p) - Sony Remote (8p)/D-Tap (0.8m/2.6ft)	Run/stop/tally for Sony Venice and Venice 2. Additional camera control supported on Hi-5 with Sony Camera Control License Key for Hi-5	Yes	Yes	No
<a href="#">K2.0015754</a>	Cable CAM (7p) – RS (0.3m/1ft)	Run/stop/tally on all ARRI Cameras and any camera that supports run/stop via a 3p Fischer connector. Can also be used power the RIA-1 without any camera connection	Yes	No	No
<a href="#">K2.0018813</a>	Cable CAM (7p) – D-Tap (0.5m/1.6ft)	For powering the RIA-1 without any camera connection	No	No	No
<a href="#">K2.0023832</a>	Cable CAM (7p, f) – CAM (7p, m) (0.3m/1ft)	Extension cable for any CAM cable	N/A	N/A	N/A
<a href="#">K2.0015759</a>	Cable CAM (7p) – ENG (12p) (0.3m/1ft)i	Can be used to inject lens metadata into Sony Venice and Venice 2 LENS connector.	N/A	N/A	N/A
<a href="#">K2.0044396</a>	Cable CineTape – SERIAL(4p) (0.8m/2.6ft)	Connects CineTape to 4p SERIAL connector on RIA-1 and ALEXA 35	N/A	N/A	N/A
<a href="#">K2.0041172</a>	Cable UDM - SERIAL (4p) (0.8m/2.6ft)	Connects UDM-1 to SERIAL connector on RIA-1 and ALEXA 35	N/A	N/A	N/A
<a href="#">K2.0025324</a>	Cable UDM – SERIAL (4p) (0.5m/1.5ft)	Connects UDM-1 to SERIAL connector on RIA-1 and ALEXA 35	N/A	N/A	N/A
N/A	Cine RT to ARRI RIA-1 / ALEXA 35	Connects Focusbug Cine RT to SERIAL connector on RIA-1 and ALEXA 35. Available only from Focusbug.	N/A	N/A	N/A

**Note: Sony and RED Camera Control Licenses required for camera control on Hi-5. ALEXA Remote License Key required for ALEXA/AMIRA camera control on WCU-4.**

# Hi-5 and RIA-1 - Sample Configurations ALEXA 35



Configuration Overview | 4.1.4 / 2026.04

## ALEXA 35 with OCU-1

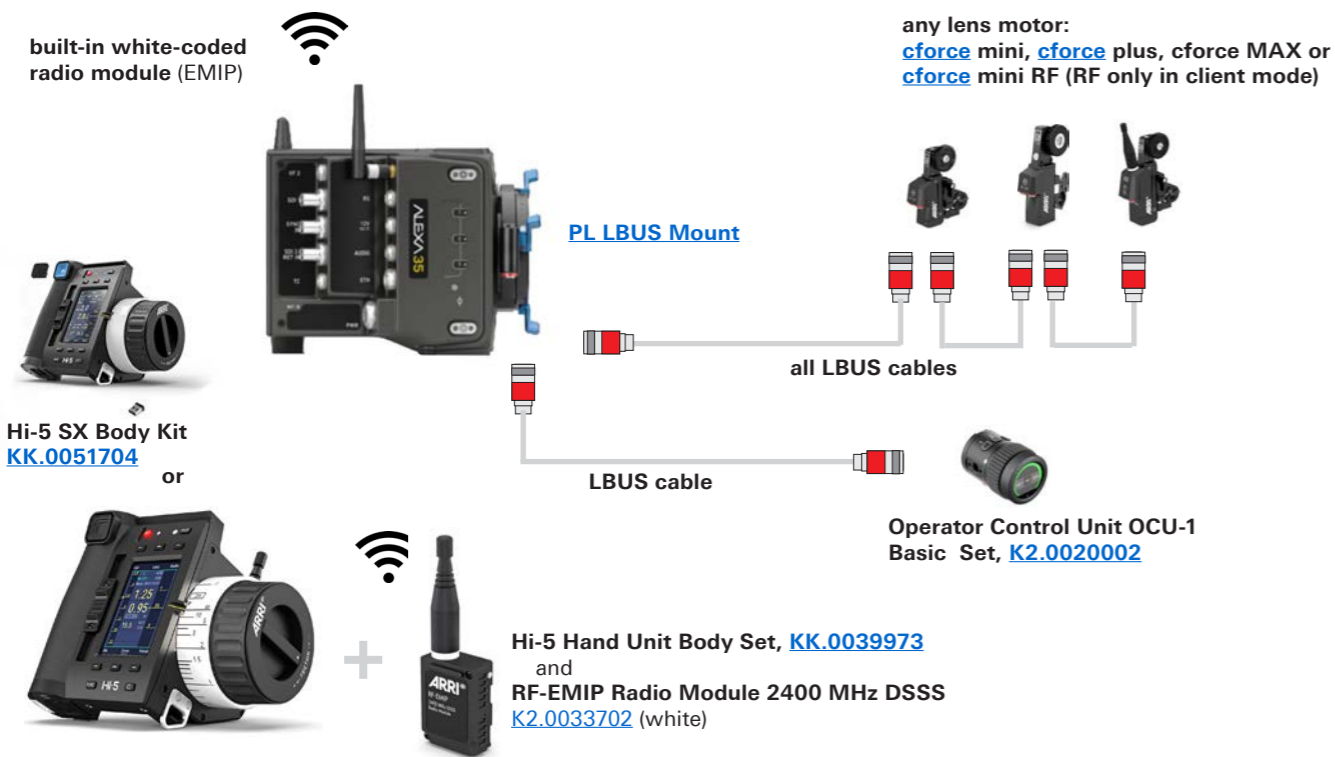

## ALEXA 35 with RIA-1 & UDM-1

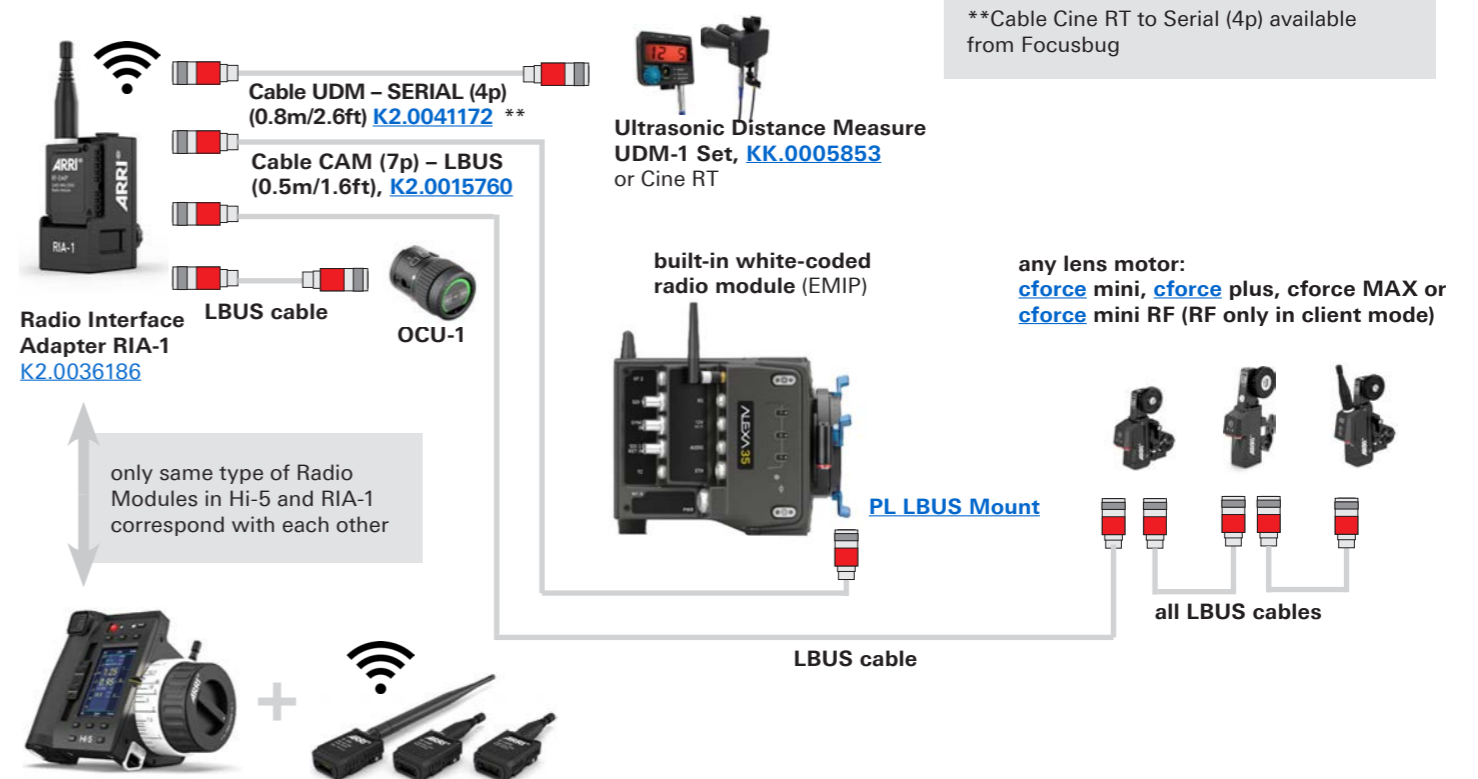

## ALEXA 35 with RIA-1 as Host & Client

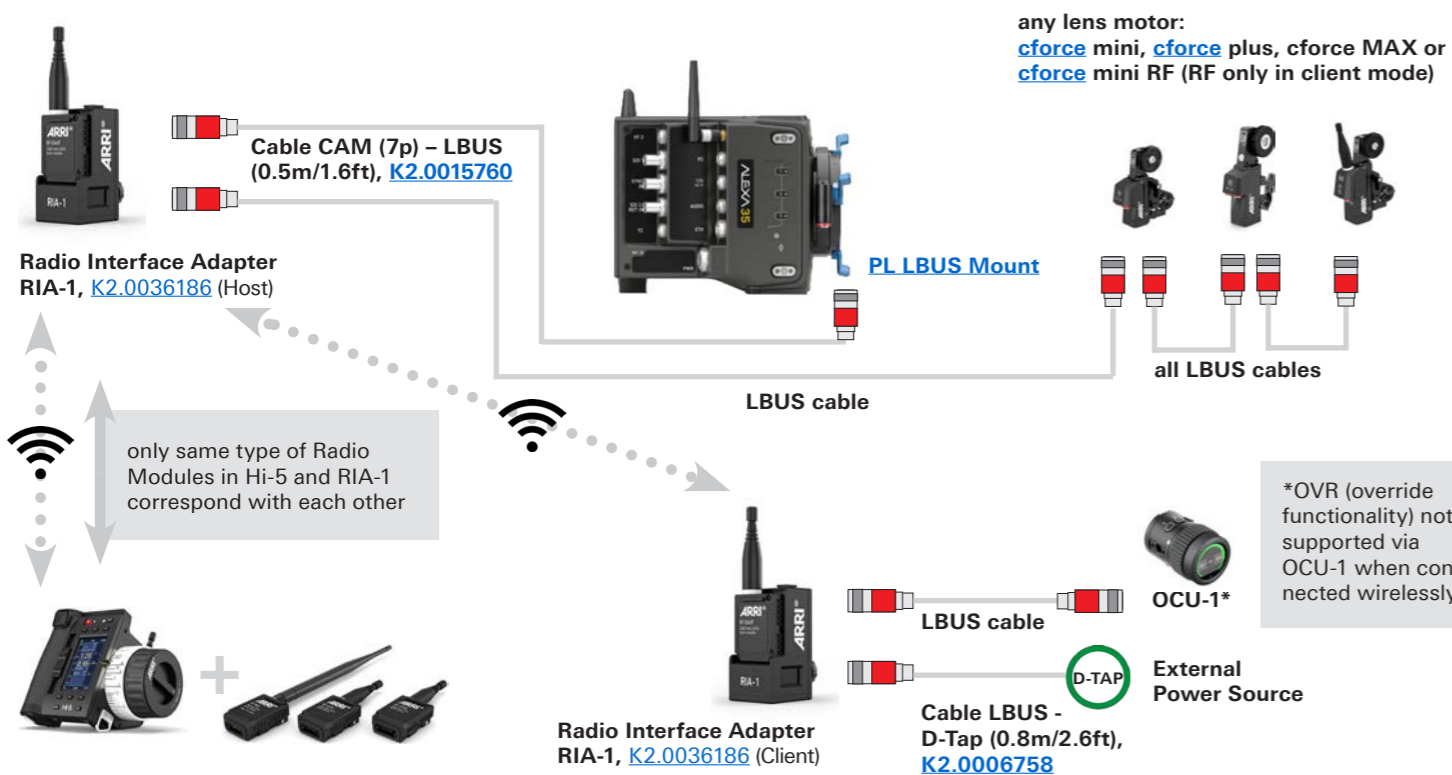

## ALEXA 35 with RIA-1 as Host & Client

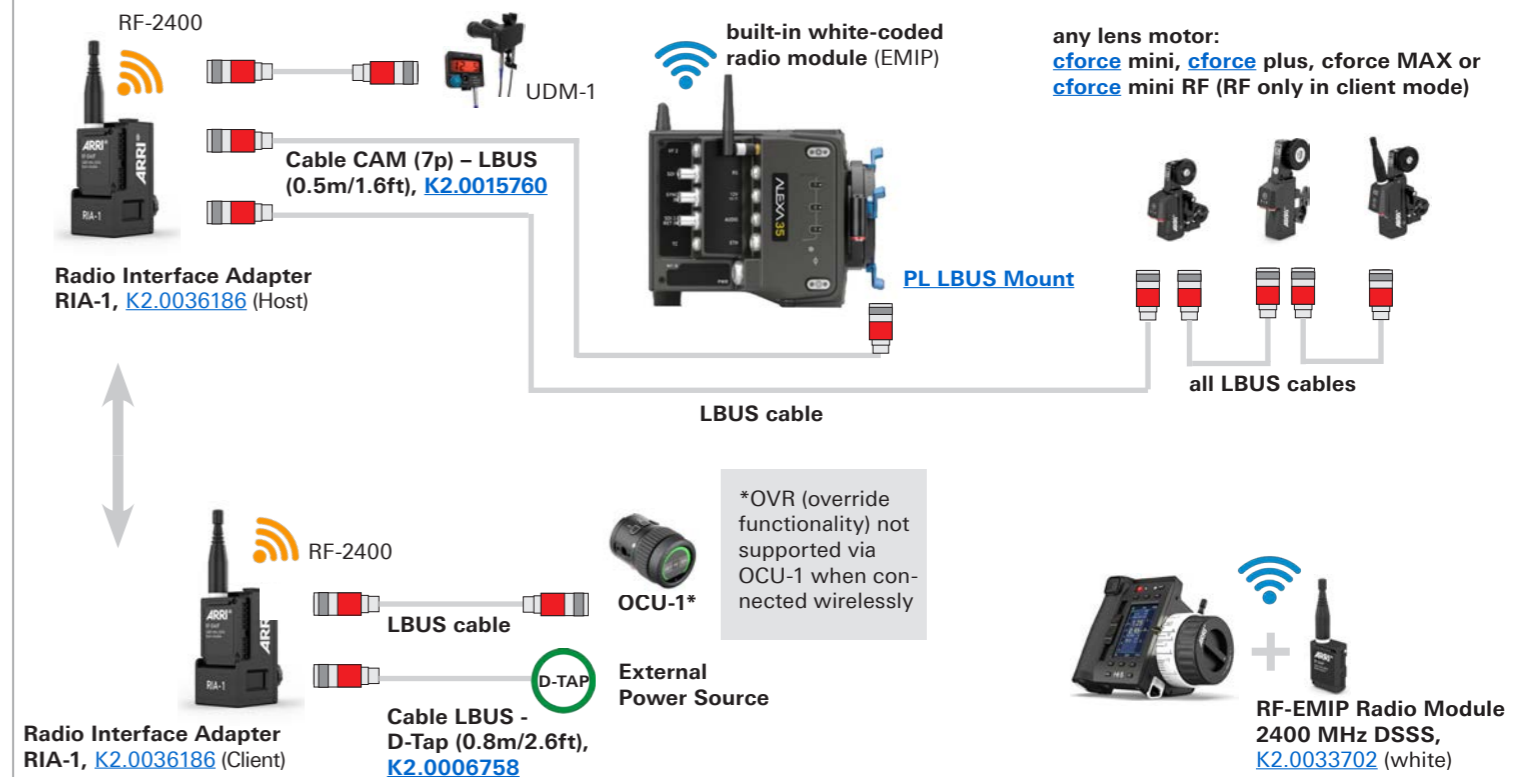

# Hi-5 and RIA-1 - Sample Configurations ALEXA Mini LF



Configuration Overview | 4.1.5 / 2026.04

## ALEXA Mini / ALEXA Mini LF with OCU-1



## ALEXA Mini / ALEXA Mini LF

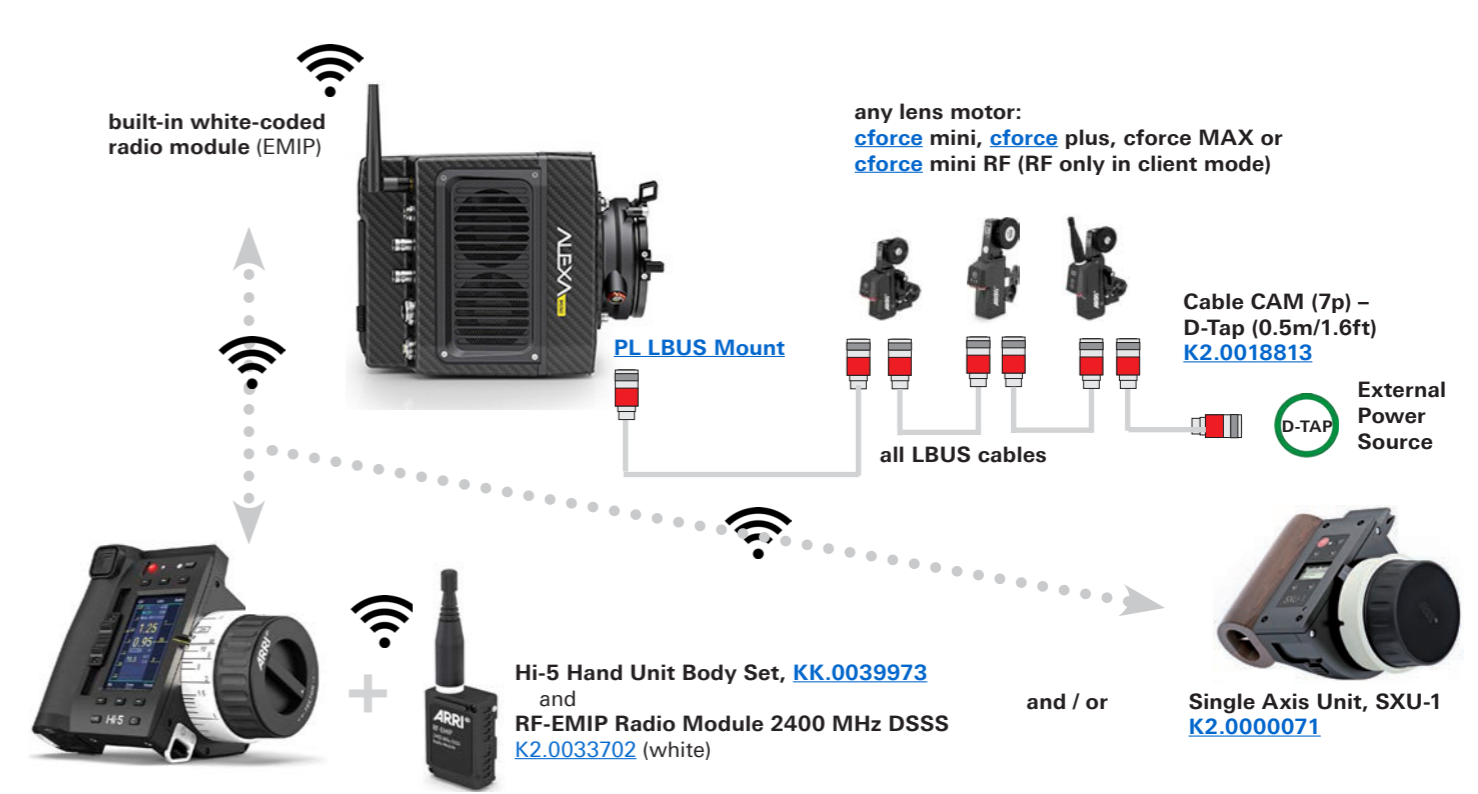

## ALEXA Mini LF with RIA-1

this ALEXA Mini LF & RIA-1 Configuration requires SUP 7.3 or higher



## ALEXA Mini LF with RIA-1 & UDM-1

this ALEXA Mini LF & RIA-1 Configuration requires SUP 7.3 or higher



# Hi-5 and RIA-1 - Sample Configurations ALEXA LF



Configuration Overview | 4.1.6 / 2026.04

## ALEXA LF / ALEXA 65 & RIA-1 & UDM-1 & cforce motors

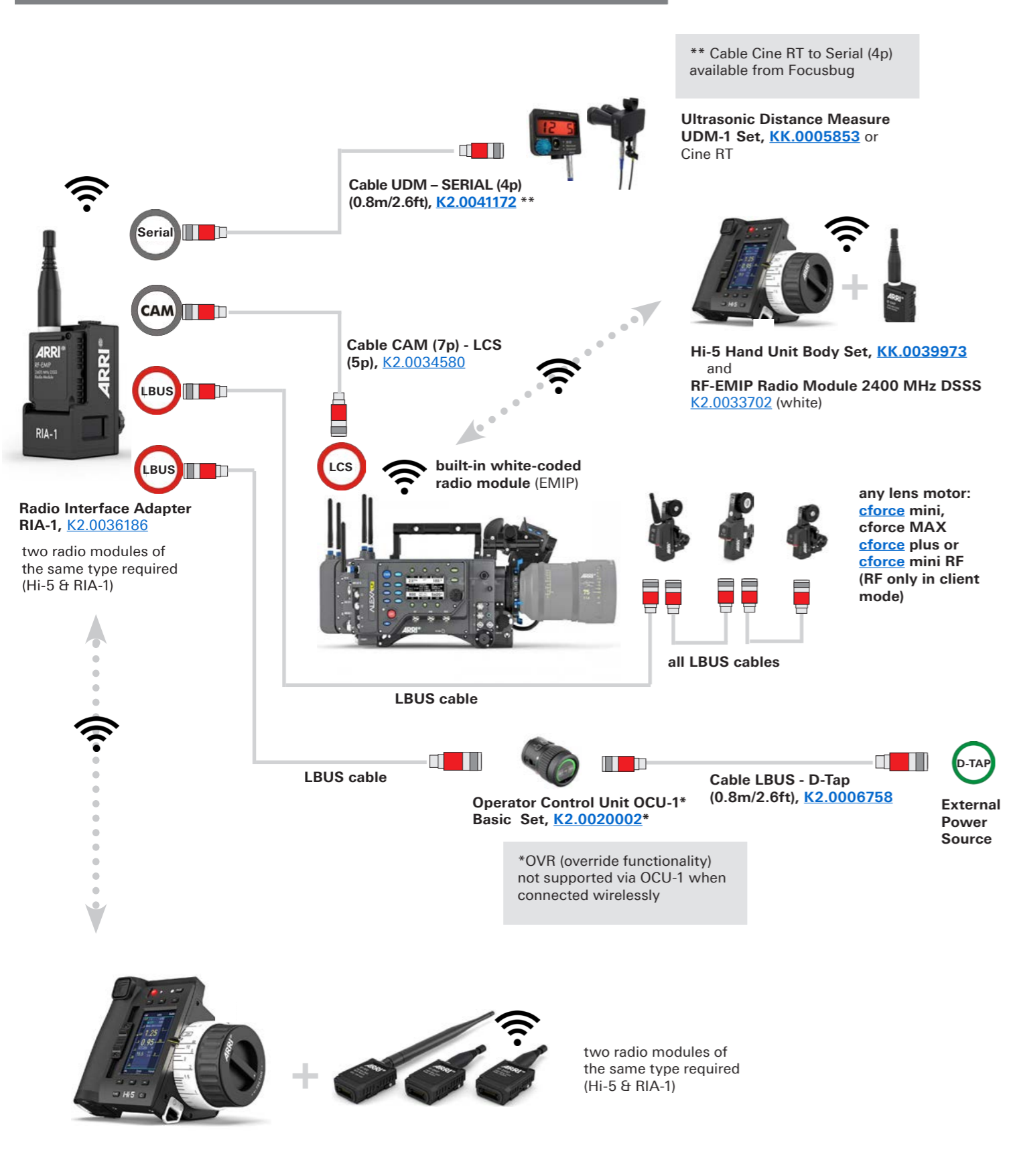

## ALEXA LF / ALEXA 65 & OCU-1 & UDM-1

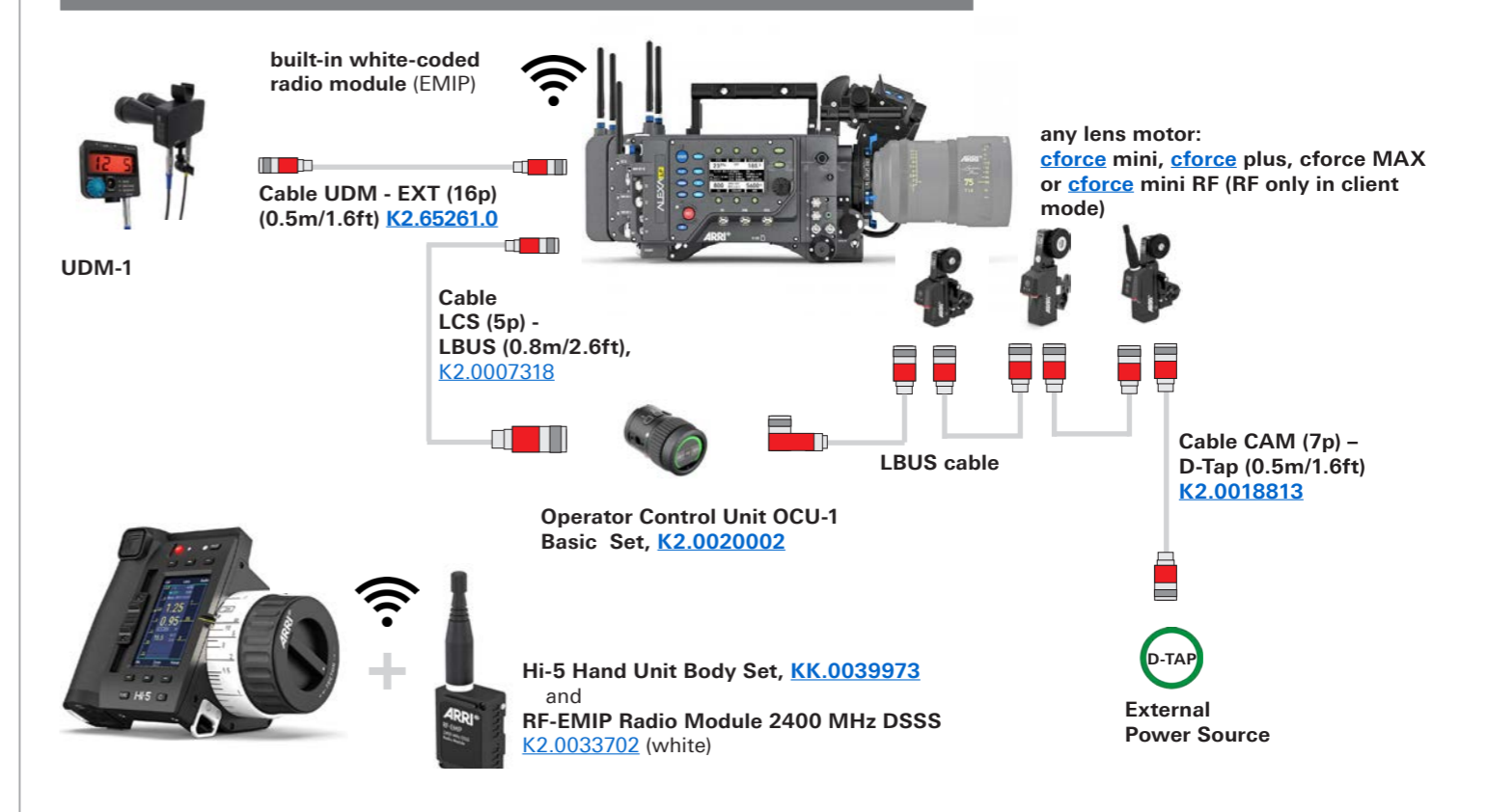

## ALEXA LF / ALEXA 65 & RIA-1 & UDM & CLM motors

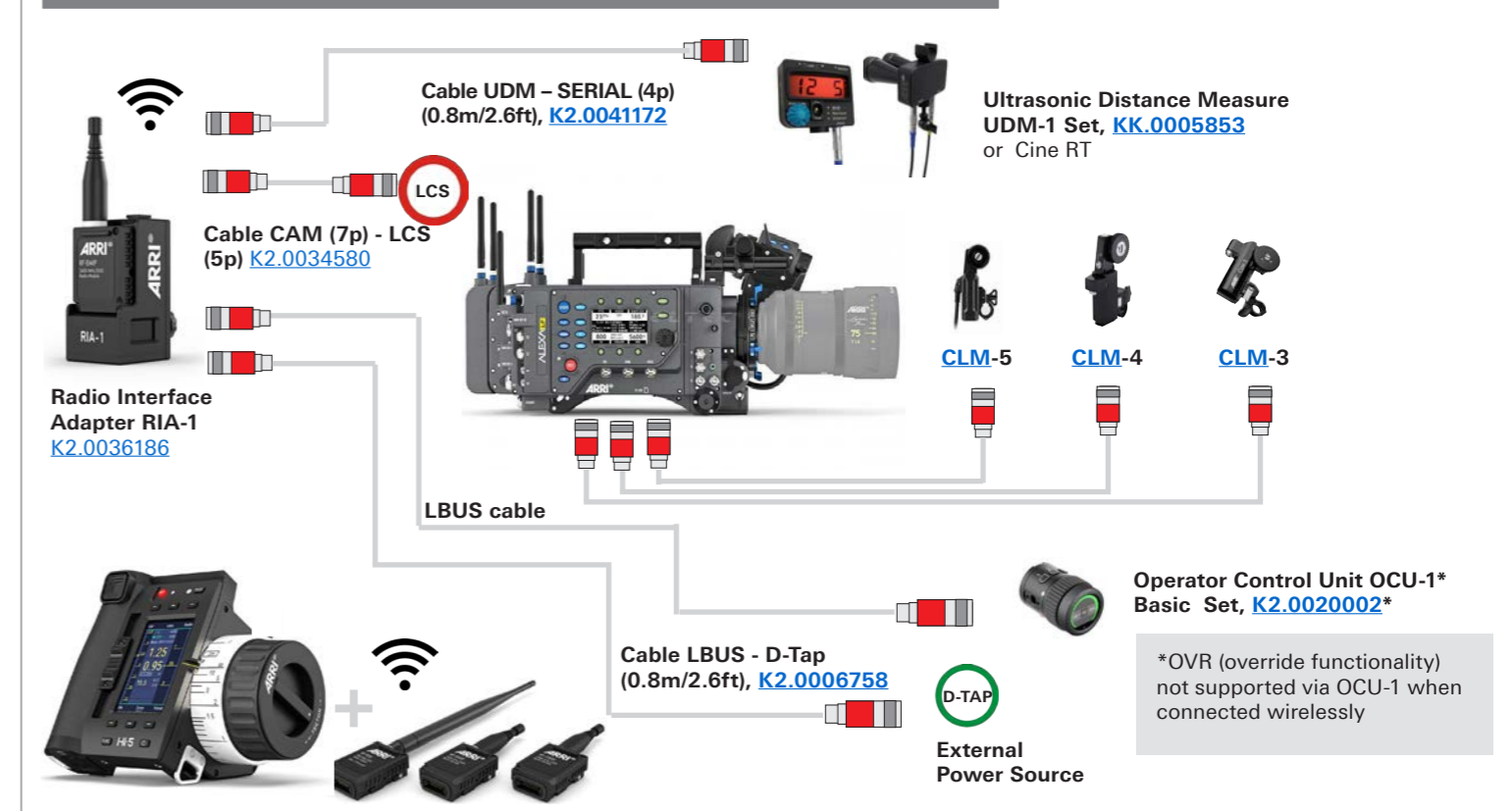

# Hi-5 and RIA-1 - Sample Configurations Amira



Configuration Overview | 4.1.7 / 2026.04

## Amira or 3rd Party Cameras & cforce mini RF motor

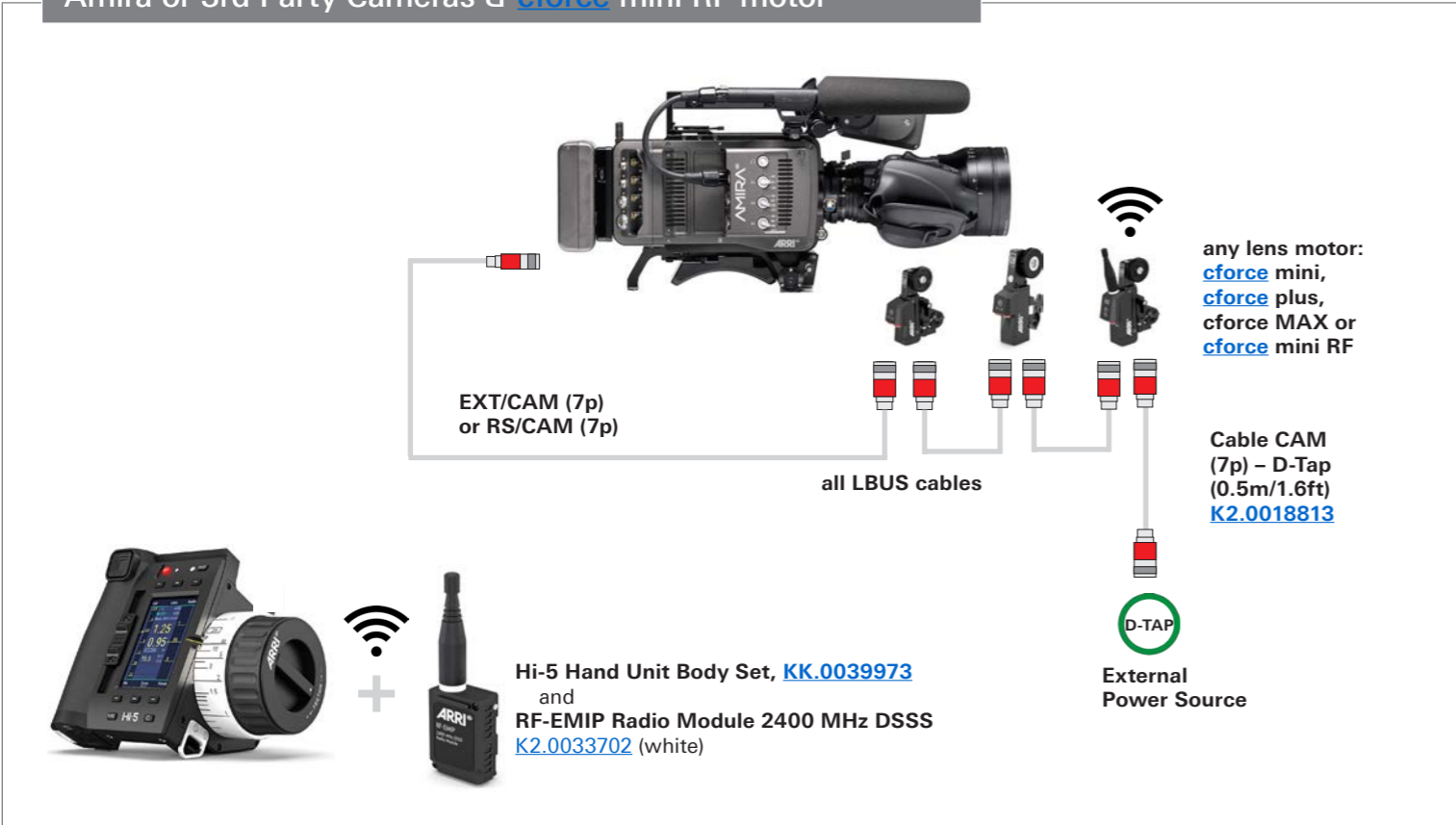

## Amira & WCU-4



## Amira or 3rd Party Cameras & cforce motors



## Amira & RIA-1 & OCU-1 or Master Grips and LBUS control units

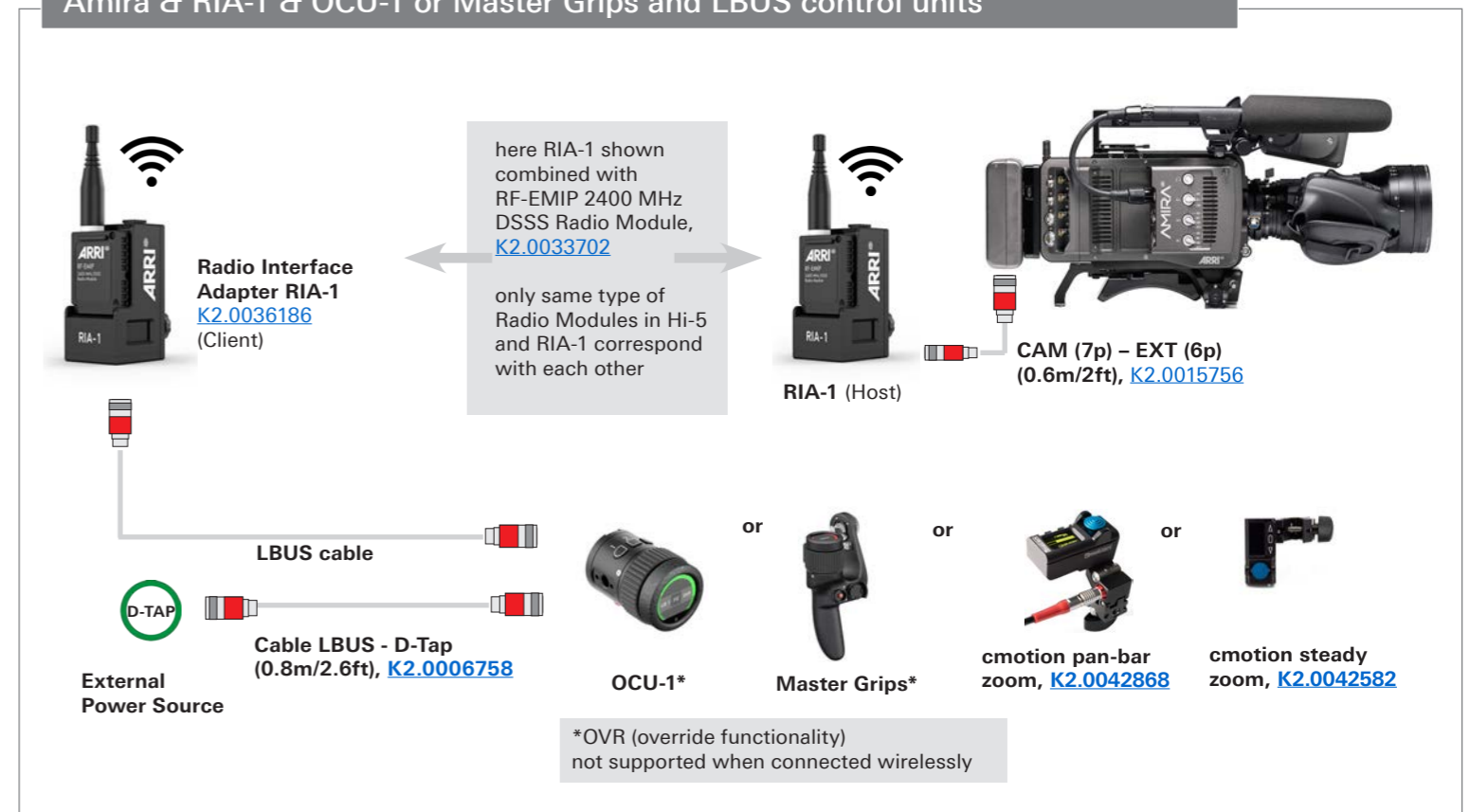

# Hi-5 and RIA-1 - Sample Configurations 3rd Party



Configuration Overview | 4.1.8 / 2026.04

## Components Configuration



## 3rd Party Cameras or Amira & UMC-4

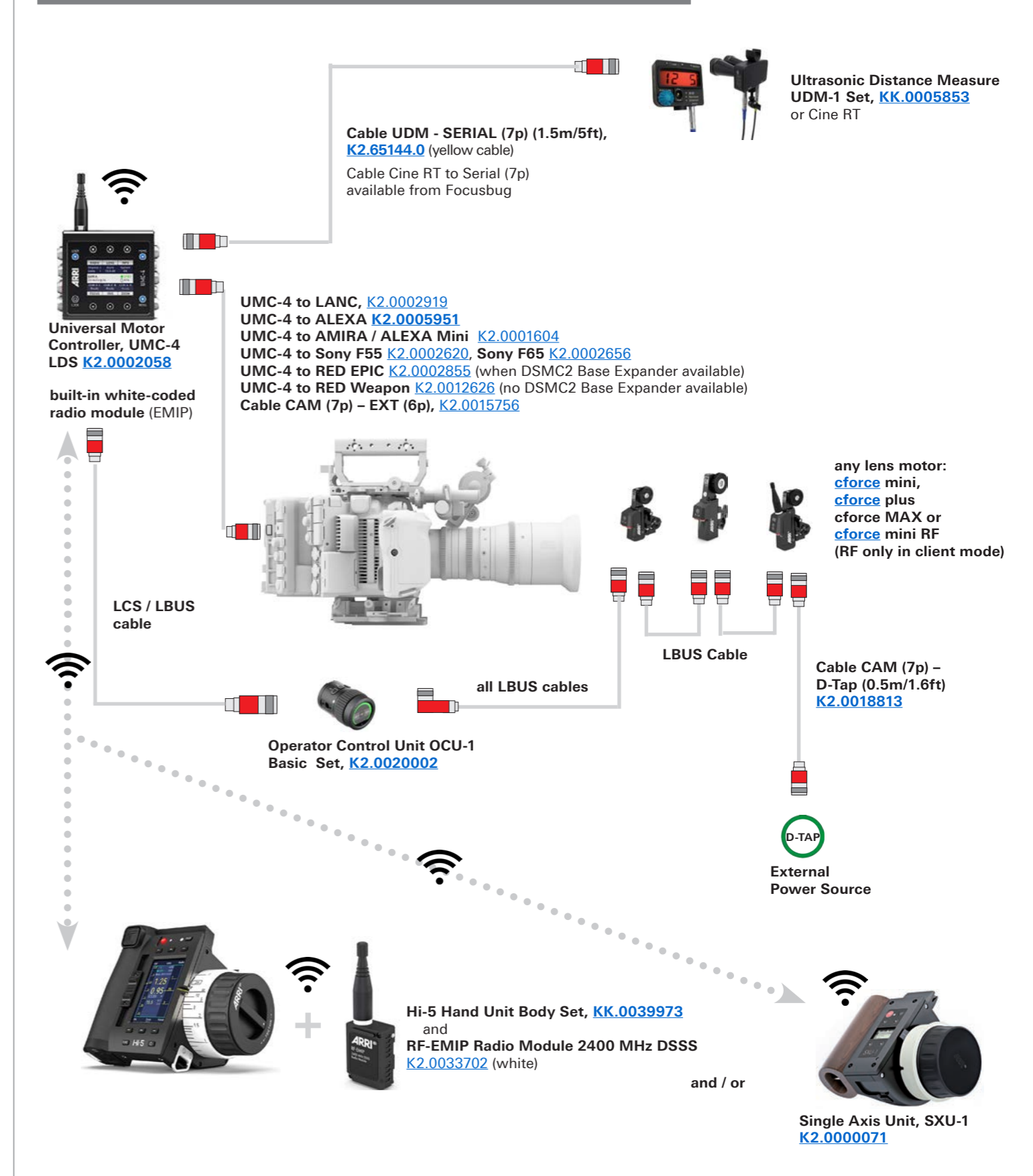

## 3rd Party & RIA-1 & OCU-1 or Master Grips and LBUS control units

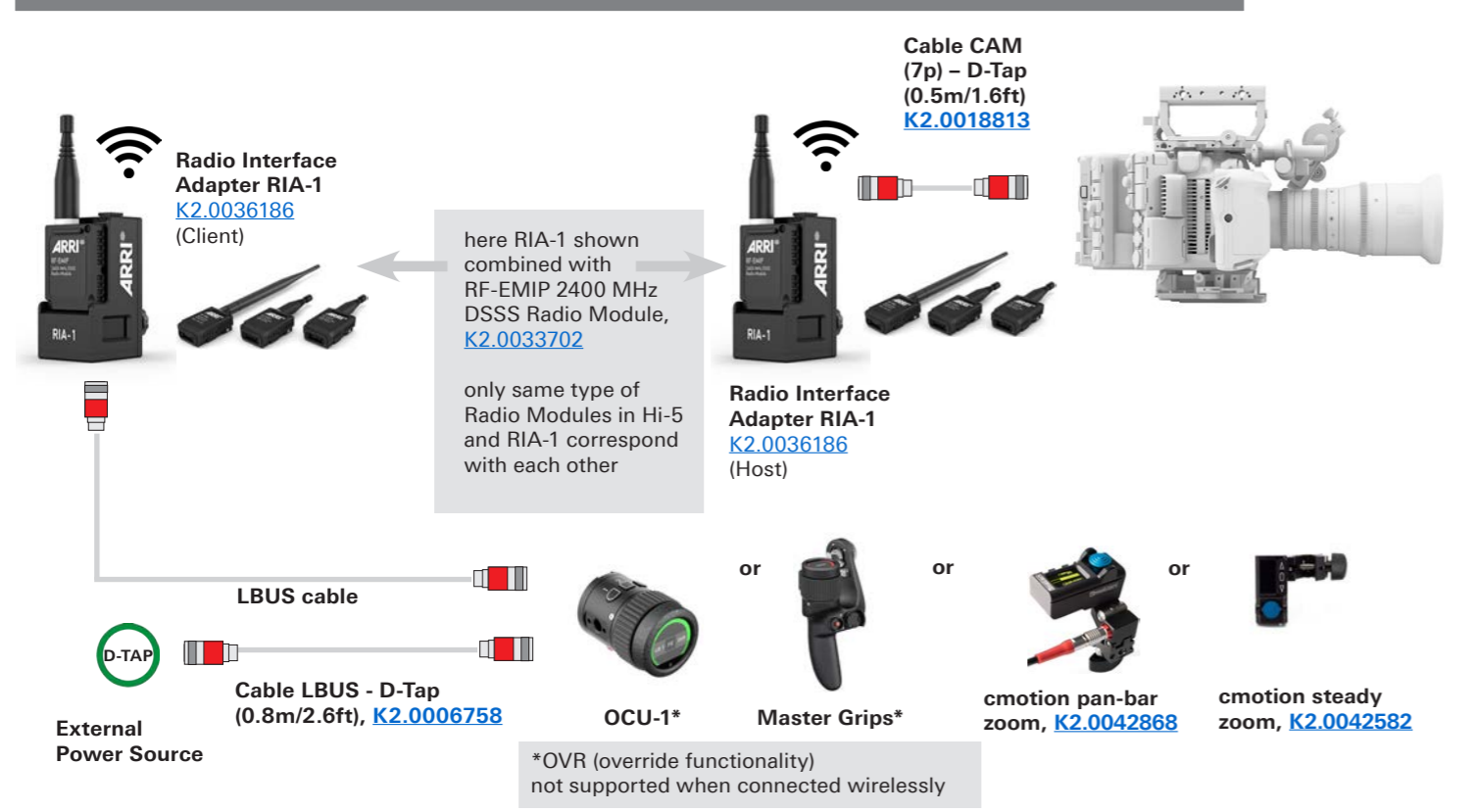

# Hi-5 and RIA-1 - Sample Configurations ALEXA Mini



Configuration Overview | 4.1.9 / 2026.04

## ALEXA Mini / ALEXA Mini LF with OCU-1



## ALEXA Mini / ALEXA Mini LF



## ALEXA Mini with RIA-1

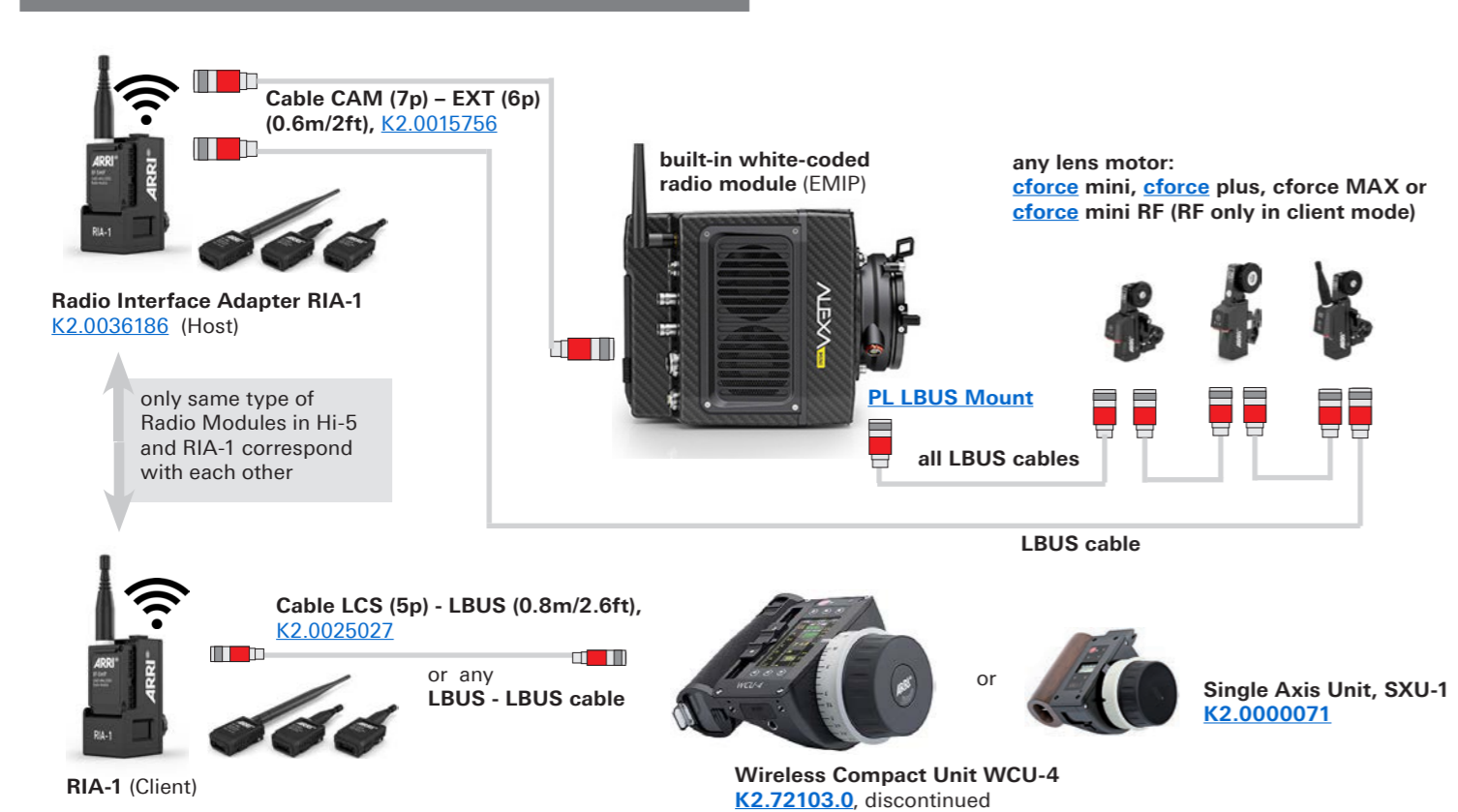

## ALEXA Mini with RIA-1 & UDM-1



# ZMU-4 & Sample Configurations ALEXA 35



Configuration Overview | 4.2.0 / 2026.04

## ZMU-4 Set



### ZMU-4 Basic Set, [KK.0043770](#)

includes:  
[K2.0039926](#) 1x ZMU-4 Zoom Main Unit Body  
[K2.0033702](#) 1x RF-EMIP Radio Module 2400 MHz DSSS  
[K2.0041744](#) 1x Rosette Adapter RA-7  
[K2.0044203](#) 1x Rosette Adapter RA-8  
[K2.0044543](#) 1x ZMU-4 ARRI Rosette

## ZMU-4 Single Items & Accessories



**ZMU-4 Body**, [K2.0039926](#)  
incl. RF Cover [K2.0039965](#)



**RF-Cover**  
[K2.0039965](#)



**Rosette Adapter RA-7**,  
[K2.0041744](#)



**Rosette Adapter RA-8**, [K2.0044203](#)



**ZMU-4 ARRI Rosette**  
[K2.0044543](#)



**Li-Ion Battery Pack**  
LBP-3500, [K2.0036022](#)



**LBP Battery Charger**  
[K2.0039874](#)

## RIA & Radio Module Sets



**RF-900 Radio Module 900 MHz FHSS Set (2x)**, [KK.0039986](#) (grey)  
includes:  
[K2.0036599](#), RF-900 Radio Module 900 MHz FHSS (2x)



**RF-EMIP Radio Module 2400 MHz DSSS Set (2x)**, [KK.0039985](#) (white)  
includes:  
[K2.0033702](#), RF-EMIP Radio Module 2400 MHz DSSS (2x)



**RF-2400 Radio Module 2400 MHz FHSS Set (2x)**, [KK.0039984](#) (orange)  
includes:  
[K2.0036598](#), RF-2400 Radio Module 2400 MHz FHSS (2x)



**Radio Interface Adapter RIA-1 Set**, [KK.0039980](#)  
includes:  
[K2.0036186](#) 1x Radio Interface Adapter RIA-1  
[K2.0039465](#) 1x RIA-1 Bracket

## ALEXA 35 Camera with ZMU-4 and Hi-5 hardwired



**ZMU-4 Body**  
[K2.0039926](#)  
for Zoom Control



**RF-EMIP Radio Module 2400 MHz DSSS**, [K2.0033702](#) (white)



**Hi-5 Hand Unit Body Set**  
[KK.0039973](#)  
for Focus & Iris Control



**Hi-5 SX Body Kit**  
[KK.0051704](#)



any lens motor:  
[cforce mini](#), [cforce plus](#), [cforce MAX](#) or  
[cforce mini RF](#) (RF only in client mode)



all LBUS cables

## ALEXA 35 Camera with ZMU-4 and Hi-5 wireless



**ZMU-4 Body**  
[K2.0039926](#)  
for Zoom Control



**RF-EMIP Radio Module 2400 MHz DSSS Set**  
[KK.0039985](#) (white)



**Hi-5 Hand Unit Body Set**  
[KK.0039973](#)  
Radio Module needed  
for Focus & Iris Control



any lens motor:  
[cforce mini](#), [cforce plus](#), [cforce MAX](#) or  
[cforce mini RF](#) (RF only in client mode)



all LBUS cables

# ZMU-4 & Sample Configurations ALEXA 35 / ALEXA Mini / ALEXA Mini LF



Configuration Overview | 4.2.1 / 2026.04

## ALEXA 35 Camera with ZMU-4 and Hi-5



## ALEXA Mini / ALEXA Mini LF with ZMU-4 & OCU-1 wireless



## ALEXA Mini / ALEXA Mini LF with ZMU-4 hardwired



## ALEXA Mini / ALEXA Mini LF with ZMU-4 wireless

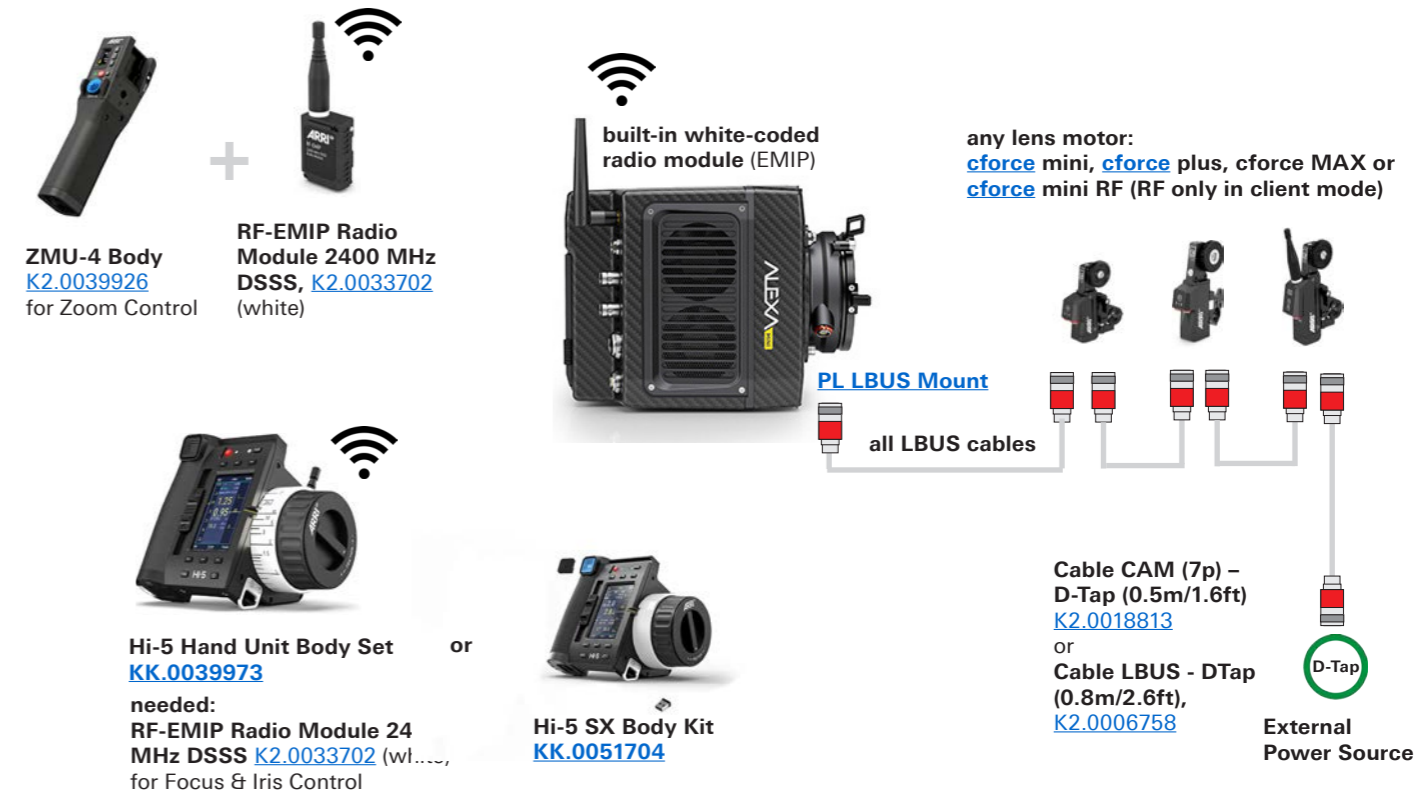

# ZMU-4 & Sample Configurations 3rd Party

Configuration Overview | 4.2.2 / 2026.04

## 3rd Party Camera with **cforce** mini RF and ZMU-4 wireless



## 3rd Party Camera with RIA-1 and ZMU-4 wireless

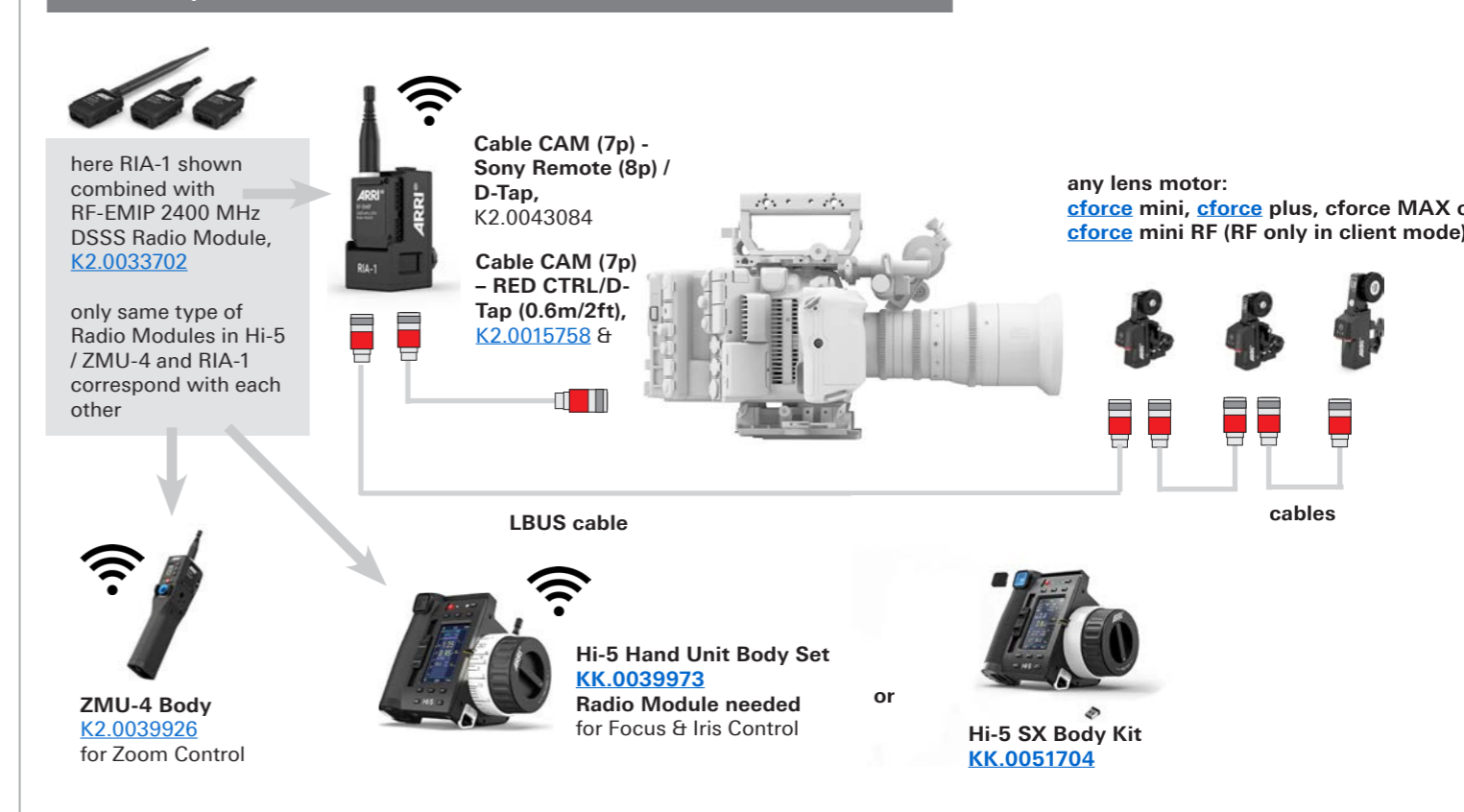

## 3rd Party Camera with ZMU-4 hardwired

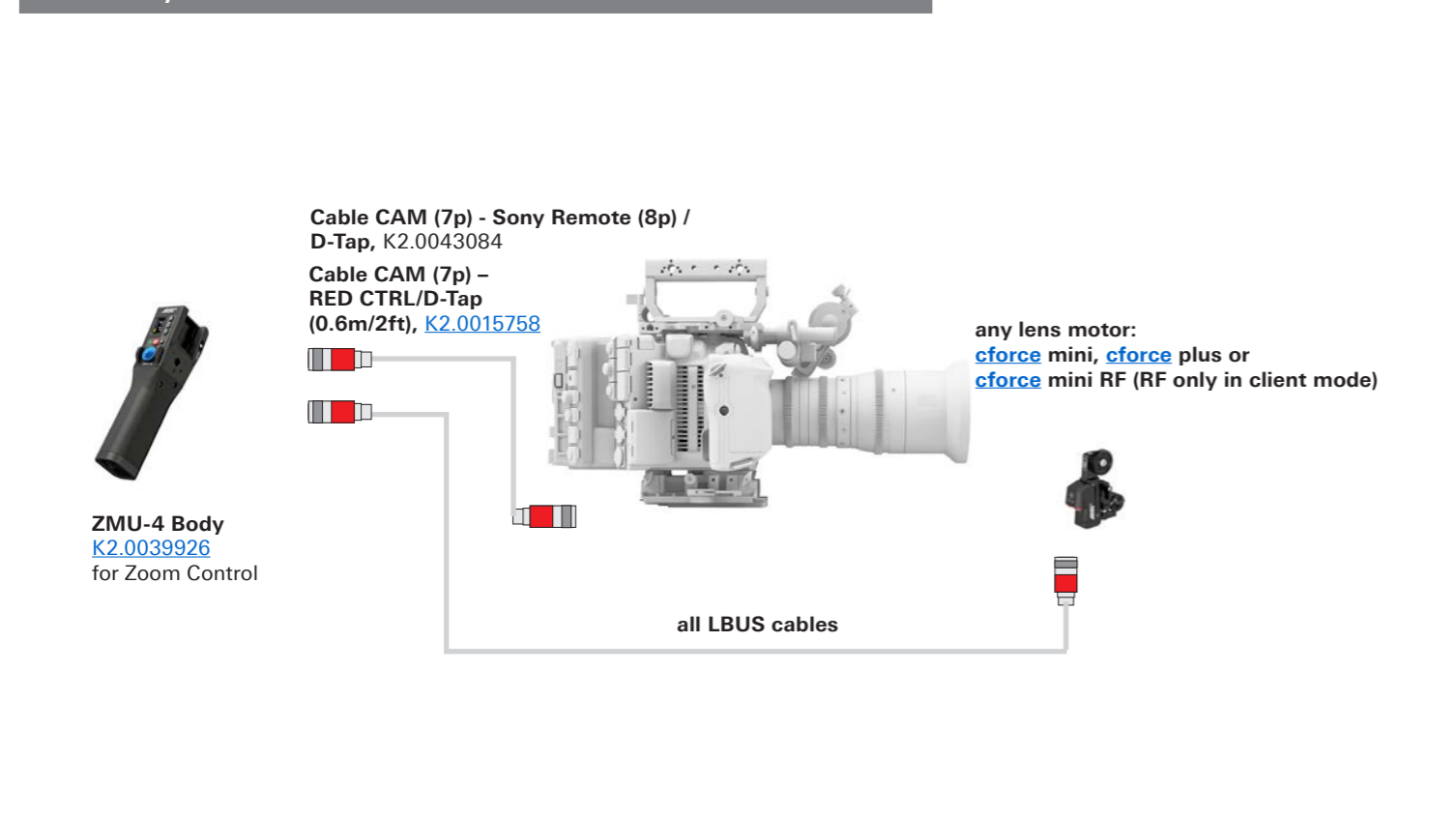

## 3rd Party Camera with ZMU-4 hardwired and Hi-5

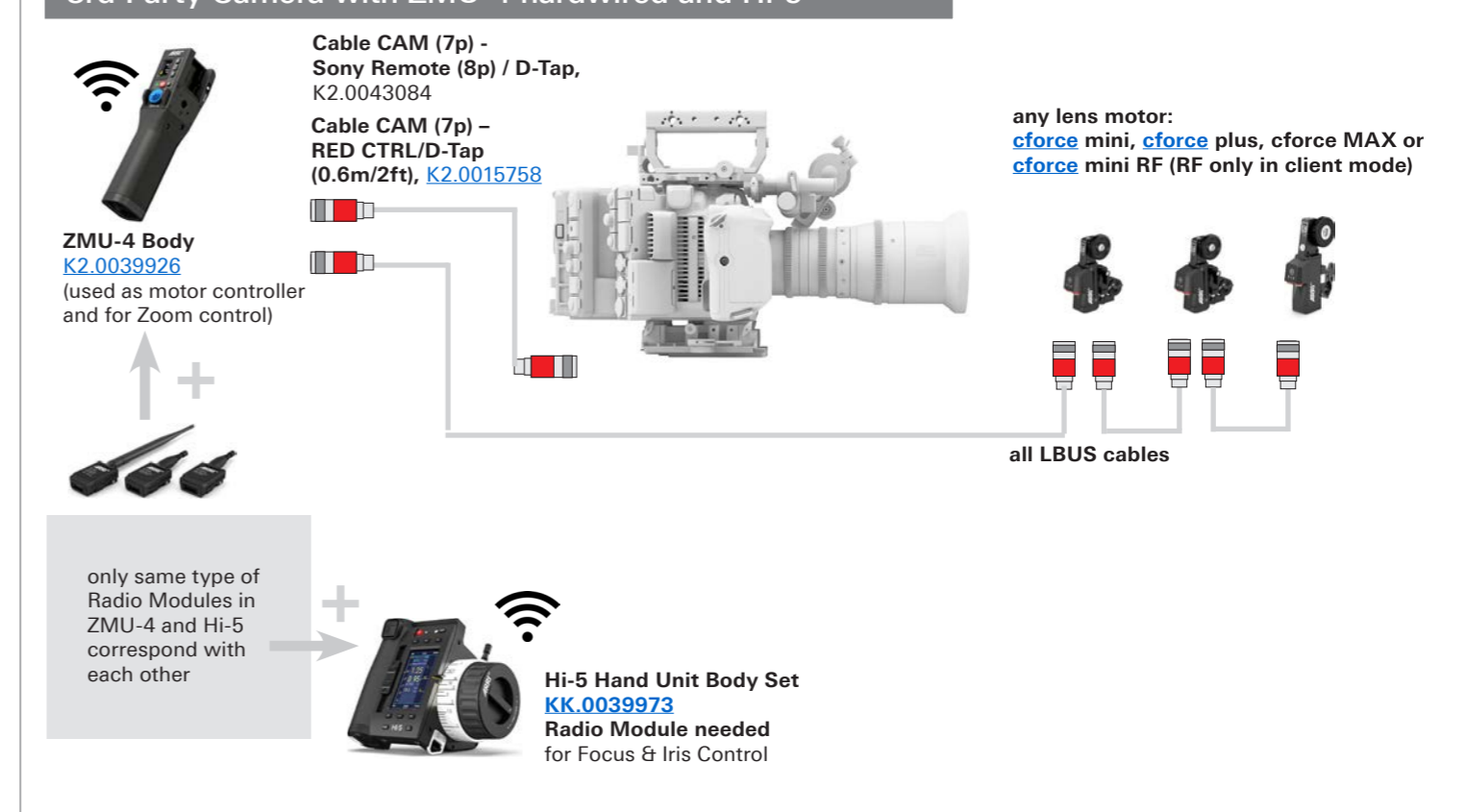

# ZMU-4 - Cable Guide



Configuration Overview | 4.2.3 / 2025.10

Item Number	Cable Name	Supported Cameras	Camera Control		
			Run/Stop?	on Hi-5	on WCU-4
<a href="#">K2.0025027</a>	Cable CAM (7p) – LBUS (0.3m/1ft)	ALEXA 35	Yes	Yes	Yes
<a href="#">K2.0015760</a>	Cable CAM (7p) – LBUS (0.5m/1.6ft)	ALEXA 35	Yes	Yes	Yes
<a href="#">K2.0015756</a>	Cable CAM (7p) – EXT (6p) (0.6m/2ft)	ALEXA Mini, ALEXA Mini LF, AMIRA	Yes	Yes	Yes
<a href="#">K2.0015755</a>	Cable CAM (7p) – EXT (16p) (0.8m/2.6ft)	ALEXA Classic EV, ALEXA XT EV, ALEXA SXT EV. Only works with ALEXA EV cameras, not ALEXA Plus	Yes	Yes	Yes
<a href="#">K2.0034580</a>	Cable CAM (7p) - LCS (5p) (0.8m/2.6ft)	ALEXA Plus cameras including ALEXA Plus, ALEXA XT Plus, ALEXA SXT Plus, ALEXA LF, ALEXA 65	Yes	Yes	Yes
<a href="#">K2.0015758</a>	Cable CAM (7p) – RED CTRL/D-Tap (0.6m/2ft)	RED DSMC2 cameras except those with Base Expander Module. RED DSMC3 cameras (Komodo/V-Raptor) with module or break-out cable from 9p Lemo EXT Connector to RED CTRL connector. Supports run/stop/tally on WCU-4 and Hi-5. Additional RED Camera Control License Key required for further camera control on Hi-5	Yes	Yes	No
<a href="#">K2.0015757</a>	Cable CAM (7p) – LANC/D-Tap (0.6m/2ft)	Many cameras with a LANC connector including Canon C300/C500 series, Sony PXW-FX9/FS7 and Blackmagic Ursa Mini Pro	Yes	No	No
<a href="#">K2.0018814</a>	Cable CAM (7p) – Sony Venice/F55 CTRL/D-Tap (0.6m/2ft)	Sony F5/F55 and Sony Venice. Not compatible with Sony Venice 2, Panasonic Varicam, Panasonic Varicam LT	Yes	No	No
<a href="#">K2.0047268</a>	Cable CAM (7p) - Sony Remote (8p)/D-Tap (0.8m/2.6ft)	Run/stop/tally for Sony Venice and Venice 2. Additional camera control supported on Hi-5 with Sony Camera Control License Key for Hi-5	Yes	Yes	No
<a href="#">K2.0015754</a>	Cable CAM (7p) – RS (0.3m/1ft)	Run/stop/tally on all ARRI Cameras and any camera that supports run/stop via a 3p Fischer connector. Can also be used power the RIA-1 without any camera connection	Yes	No	No
<a href="#">K2.0018813</a>	Cable CAM (7p) – D-Tap (0.5m/1.6ft)	For powering the RIA-1 without any camera connection	No	No	No
<a href="#">K2.0023832</a>	Cable CAM (7p, f) – CAM (7p, m) (0.3m/1ft)	Extension cable for any CAM cable	N/A	N/A	N/A
<a href="#">K2.0015759</a>	Cable CAM (7p) – ENG (12p) (0.3m/1ft)	Can be used to inject lens metadata into Sony Venice and Venice 2 LENS connector.	N/A	N/A	N/A

Note: Sony and RED Camera Control Licenses required for camera control on Hi-5. ALEXA Remote License Key required for ALEXA/AMIRA camera control on WCU-4.

## Master Grips Sets

Note: **cforce** motors, respective LBUS cables and 15mm rods/supporting hardware not included!



For sets with Standard Grips please contact your local dealer

**Master Grip Prime Set for AMIRA** K0.0013095  
includes:  
Master Grip Right Wheel MRW-1 [K2.0009494](#)  
Master Grip Left Wheel MLW-1 [K2.0009363](#)  
Handgrip Extension 160 mm (2x) [K2.0012911](#)  
Cable Clip 15 mm (2x) [K2.0012921](#)  
Extension Tube for Handgrip [K2.47136.0](#)  
Rod Mounting Bracket RMB-4 [K2.0013007](#)  
15 mm Reduction Insert [K2.66255.0](#)  
Cable LBUS (angled) to AMIRA EXT (straight) 80 cm [K2.0012628](#)  
Cable LBUS (angled) to LBUS (angled) 60 cm [K2.0013040](#)  
Master Grip Case [K2.0012965](#)

**Master Grip Prime Set for ALEXA Plus/Studio** K0.0013090  
includes:  
Master Grip Right Wheel MRW-1 [K2.0009494](#)  
Master Grip Left Wheel MLW-1 [K2.0009363](#)  
Handgrip Extension 160 mm (2x) [K2.0012911](#)  
Cable Clip 15 mm (2x) [K2.0012921](#)  
Extension Tube for Handgrip [K2.47136.0](#)  
Cable LBUS (angled) to LCS 80 cm [K2.0013044](#)  
Cable LBUS (angled) to LBUS (angled) 60 cm [K2.0013040](#)  
Master Grip Case [K2.0012965](#)

**Master Grip Zoom Set for ALEXA Plus/Studio** K0.0013094  
includes:  
Master Grip Right Rocker MRR-1 [K2.0009493](#)  
Master Grip Left Wheel MLW-1 [K2.0009363](#)  
Handgrip Extension 160 mm (2x) [K2.0012911](#)  
Cable Clip 15 mm (2x) [K2.0012921](#)  
Extension Tube for Handgrip [K2.47136.0](#)  
Cable LBUS (angled) to LCS 80 cm [K2.0013044](#)  
Cable LBUS (angled) to LBUS (angled) 60 cm [K2.0013040](#)  
Master Grip Case [K2.0012965](#)

**Master Grip Prime Set for ALEXA Mini** K0.0013093  
includes:  
Master Grip Right Wheel MRW-1 [K2.0009494](#)  
Master Grip Left Wheel MLW-1 [K2.0009363](#)  
Handgrip Extension 160 mm (2x) [K2.0012911](#)  
Cable Clip 15 mm (2x) [K2.0012921](#)  
Extension Tube for Handgrip [K2.47136.0](#)  
Cable LBUS (angled) to LBUS (straight) 35 cm [K2.0013042](#)  
Cable LBUS (angled) to LBUS (angled) 60 cm [K2.0013040](#)  
Master Grip Case [K2.0012965](#)

**Master Grip Zoom Set for ALEXA Mini** K0.0013089  
includes:  
Master Grip Right Rocker MRR-1 [K2.0009493](#)  
Master Grip Left Wheel MLW-1 [K2.0009363](#)  
Handgrip Extension 160 mm (2x) [K2.0012911](#)  
Cable Clip 15 mm (2x) [K2.0012921](#)  
Extension Tube for Handgrip [K2.47136.0](#)  
Cable LBUS (angled) to LBUS (straight) 35 cm [K2.0013042](#)  
Cable LBUS (angled) to LBUS (angled) 60 cm [K2.0013040](#)  
Master Grip Case [K2.0012965](#)

**Master Grip Zoom Set for AMIRA** K0.0013088  
includes:  
Master Grip Right Rocker MRR-1 [K2.0009493](#)  
Master Grip Left Wheel MLW-1 [K2.0009363](#)  
Handgrip Extension 160 mm (2x) [K2.0012911](#)  
Cable Clip 15 mm (2x) [K2.0012921](#)  
Extension Tube for Handgrip [K2.47136.0](#)  
Rod Mounting Bracket RMB-4 [K2.0013007](#)  
15 mm Reduction Insert [K2.66255.0](#)  
Cable LBUS (angled) to AMIRA EXT (straight) 80 cm [K2.0012628](#)  
Cable LBUS (angled) to LBUS (angled) 60 cm [K2.0013040](#)  
Master Grip Case [K2.0012965](#)

**Master Grip Prime Set for 3rd-Party Cameras** K0.0013091  
includes:  
Master Grip Right Wheel MRW-1 [K2.0009494](#)  
Master Grip Left Wheel MLW-1 [K2.0009363](#)  
Handgrip Extension 160 mm (2x) [K2.0012911](#)  
Cable Clip 15 mm (2x) [K2.0012921](#)  
Extension Tube for Handgrip [K2.47136.0](#)  
LCUBE CUB-1 [K2.0008630](#)  
LCUBE Bracket [K2.0009620](#)  
Cable LBUS (angled) to LBUS (angled) 60 cm [K2.0013040](#)  
Cable CUB-1 to F5/55 cameras [K2.0012631](#)  
Cable CUB-1 to RED cameras [K2.0012632](#)  
Cable CUB-1 to LANC [K2.0012633](#)  
Master Grip Case [K2.0012965](#)

**Master Grip Zoom Set for 3rd-Party Cameras** K0.0013092  
includes:  
Master Grip Right Rocker MRR-1 [K2.0009493](#)  
Master Grip Left Wheel MLW-1 [K2.0009363](#)  
Handgrip Extension 160 mm (2x) [K2.0012911](#)  
Cable Clip 15 mm (2x) [K2.0012921](#)  
Extension Tube for Handgrip [K2.47136.0](#)  
LCUBE CUB-1 [K2.0008630](#)  
LCUBE CUB-2 [K2.0010681](#)  
LCUBE Bracket (2x) [K2.0009620](#)  
Cable LBUS (angled) to LBUS (angled) 60 cm [K2.0013040](#)  
Cable CUB-1 to F5/55 cameras [K2.0012631](#)  
Cable CUB-1 to LANC [K2.0012632](#)  
Master Grip Case [K2.0012633](#)  
[K2.0012965](#)

## Master Grips Single Parts



Master Grip Left Wheel MLW-1 [K2.0009363](#)



Master Grip Right Wheel MRW-1 [K2.0009494](#)



Master Grip Left Rocker MLR-1 [K2.0009490](#)



Master Grip Right Rocker MRR-1 [K2.0009493](#)



Standard Grip Left SGL-1, [K2.0016317](#)



Standard Grip Right SGR-1, [K2.0016318](#)



Handgrip Extension 80 mm, [K2.0012913](#)



Handgrip Extension 160 mm, [K2.0012911](#)



Handgrip Extension 240 mm, [K2.0012917](#)



Extension Tube [K2.47136.0](#)



Pan Bar Adapter 18 mm, [K2.0012918](#)



Pan Bar Adapter 20 mm, [K2.0012919](#)



Pan Bar Clamp [K2.0012920](#)



Master Grip case [K2.0012965](#)



Rod Mounting Bracket RMB-4, [K2.0013007](#)



15 mm Cable Clip [K2.0012921](#)



LCUBE CUB-2 Basic Set [KK.0013217](#)



LCUBE - CUB-1 (Basic Set) [KK.0009001](#)

## Cables



Cable LBUS (angled) to AMIRA EXT (straight) Length: 0.8m/2.6ft, [K2.0012628](#)  
Cable LBUS (angled) to LCS Length: 0.80m/2.6ft, [K2.0013044](#)

Cable LBUS (angled) to LBUS (straight) Length: 0.35m/1.1ft, [K2.0013042](#)  
Cable LBUS (angled) to LBUS (straight) Length: 0.80m/2.6ft, [K2.0013043](#)  
Cable LBUS (angled) to LBUS (straight) Length: 1m/3.3ft, [K2.0013041](#)  
Cable LBUS (angled) to LBUS (angled) Length: 0.2m/8", [K2.0012785](#)  
Cable LBUS (angled) to LBUS (angled) Length: 0.6m/2ft, [K2.0013040](#)  
Cable LBUS (angled) to LBUS (angled) Length: 0.8m/2.6ft, [K2.0012630](#)

Cable LENS/ENG (12p) - Hi (12p) analog, [K2.0022328](#)

for further LBUS cables (angled or straight) please contact your local dealer.

## ALEXA Plus / Studio - Cine Style Lens



## 3rd Party Camera - Cine Lens

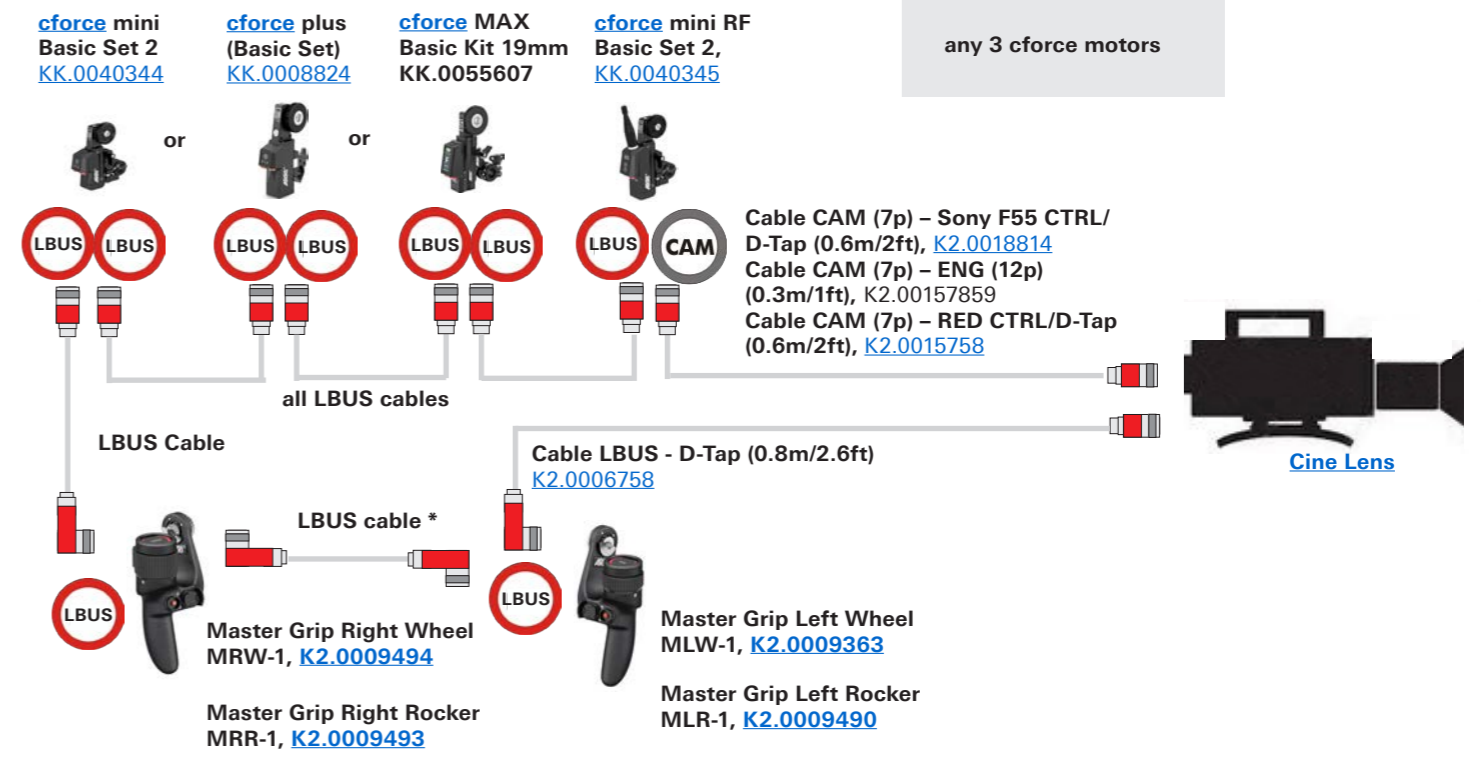

## LBUS Cables

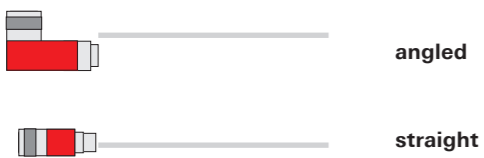

LBUS cables need to be ordered separately

- Cable LBUS (straight) to LBUS (straight) Length: 0.2m/8", [K2.0006749](#)
- Cable LBUS (straight) to LBUS (straight) Length: 0.3m/1ft, [K2.0006750](#)
- Cable LBUS (straight) to LBUS (straight) Length: 0.5m/1.5ft, [K2.0006751](#)
- Cable LBUS (straight) to LBUS (straight) Length: 0.8m/2.5ft, [K2.0006752](#)
- Cable LBUS (straight) to LBUS (straight) Length: 1.5m/5ft, [K2.0006753](#)
- Cable LBUS (straight) to LBUS (straight) Length: 3m/10ft, [K2.0006754](#)
- Cable LBUS (straight) to LBUS (straight) Length: 6m/20ft, [K2.0006755](#)
- Cable LBUS (straight) to LBUS (straight) Length: 15m/49ft, [K2.0006756](#)
- Cable LCS (5p) - LBUS (0.8m/2.6ft): [K2.0007318](#)
- Cable LBUS (angled) to LBUS (straight) Length: 0.35m/1.1ft, [K2.0013042](#)
- Cable LBUS (angled) to LBUS (straight) Length: 0.80m/2.3ft, [K2.0013043](#)
- Cable LBUS (angled) to LBUS (straight) Length: 1m/3.3ft, [K2.0013041](#)
- Cable LBUS (angled) to LBUS (straight) Length: 0.3m/1", [K2.0051681](#)
- Cable LBUS (angled) to LBUS (angled) Length: 0.2m/8", [K2.0012785](#)
- Cable LBUS (angled) to LBUS (angled) Length: 0.6m/2ft, [K2.0013040](#)
- Cable LBUS (angled) to LBUS (angled) Length: 0.8m/2.6ft, [K2.0012630](#)

Cable LBUS Star (0.2m/8in). [K2.0023823](#)

## Standard Grips & Extensions



## 3rd Party Camera - Servo Zoom Lens

Servo zoom control requires at least AMIRA/ALEXA Mini SUP 5.0

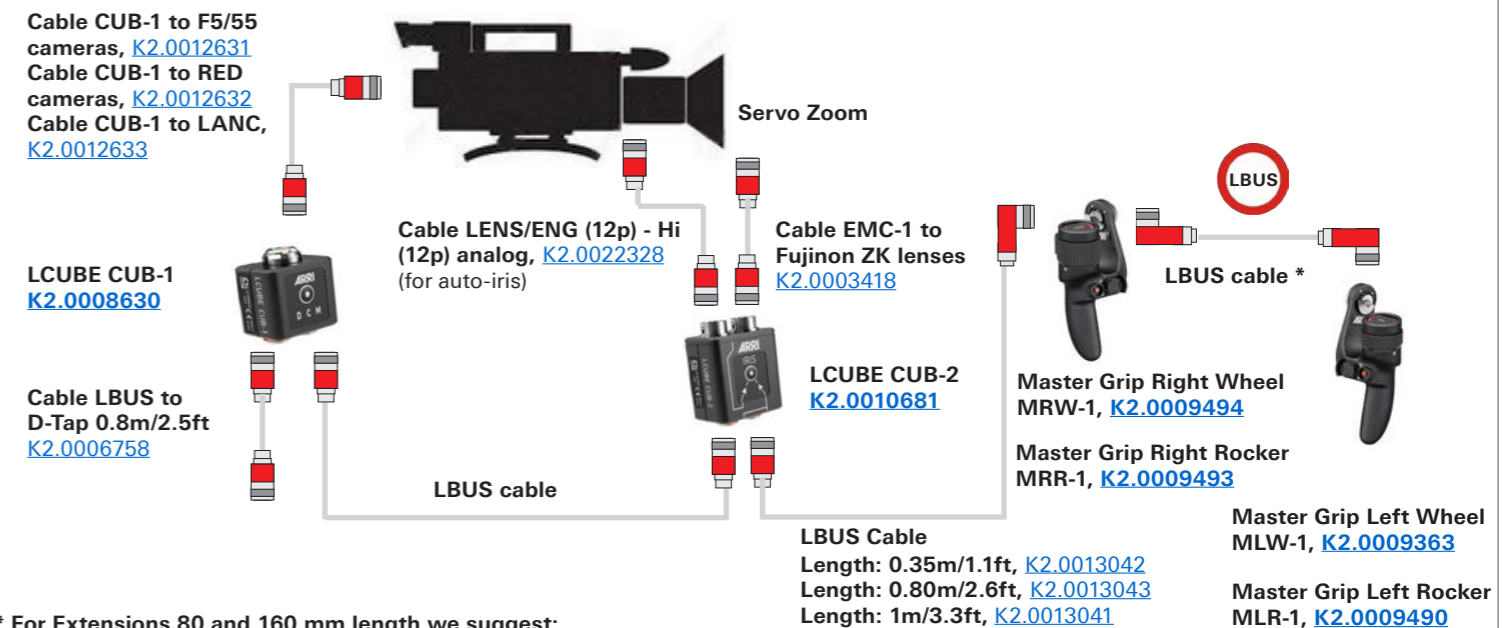

- \* For Extensions 80 and 160 mm length we suggest: Cable LBUS (angled) to LBUS (angled) Length: 0.6m/2ft, [K2.0013040](#)
- \* For Extensions 240 mm length we suggest: Cable LBUS (angled) to LBUS (angled) Length: 0.8m/2.6ft, [K2.0012630](#)

# Master Grips - Sample Configurations AMIRA



Configuration Overview | 4.3.2 / 2026.04

## AMIRA - Cine Style Lens



## AMIRA - Servo Zoom Lens

Servo zoom control requires AMIRA/ALEXA Mini SUP 5.0



## AMIRA - EF Lens

EF lens control requires AMIRA/ALEXA Mini SUP 5.0



## LBUS Cables



LBUS cables need to be ordered separately

Cable LBUS (straight) to LBUS (straight) Length: 0.2m/8", [K2.0006749](#)  
 Cable LBUS (straight) to LBUS (straight) Length: 0.3m/1ft, [K2.0006750](#)  
 Cable LBUS (straight) to LBUS (straight) Length: 0.5m/1.5ft, [K2.0006751](#)  
 Cable LBUS (straight) to LBUS (straight) Length: 0.8m/2.5ft, [K2.0006752](#)  
 Cable LBUS (straight) to LBUS (straight) Length: 1.5m/5ft, [K2.0006753](#)  
 Cable LBUS (straight) to LBUS (straight) Length: 3m/10ft, [K2.0006754](#)  
 Cable LBUS (straight) to LBUS (straight) Length: 6m/20ft, [K2.0006755](#)  
 Cable LBUS (straight) to LBUS (straight) Length: 15m/49ft, [K2.0006756](#)  
 Cable LCS (5p) - LBUS (0.8m/2.6ft): [K2.0007318](#)

Cable LBUS (angled) to LBUS (straight) Length: 0.35m/1.1ft, [K2.0013042](#)  
 Cable LBUS (angled) to LBUS (straight) Length: 0.80m/2.3ft, [K2.0013043](#)  
 Cable LBUS (angled) to LBUS (straight) Length: 1m/3.3ft, [K2.0013041](#)  
 Cable LBUS (angled) to LBUS (straight) Length: 0.3m/1", [K2.0051681](#)  
 Cable LBUS (angled) to LBUS (angled) Length: 0.2m/8", [K2.0012785](#)  
 Cable LBUS (angled) to LBUS (angled) Length: 0.6m/2ft, [K2.0013040](#)  
 Cable LBUS (angled) to LBUS (angled) Length: 0.8m/2.6ft, [K2.0012630](#)

Cable LBUS Star (0.2m/8in). [K2.0023823](#)

## Standard Grips & Extensions



# Master Grips - Sample Configurations ALEXA Mini



Configuration Overview | 4.3.3 / 2026.04

## ALEXA Mini - Cine Style Lens

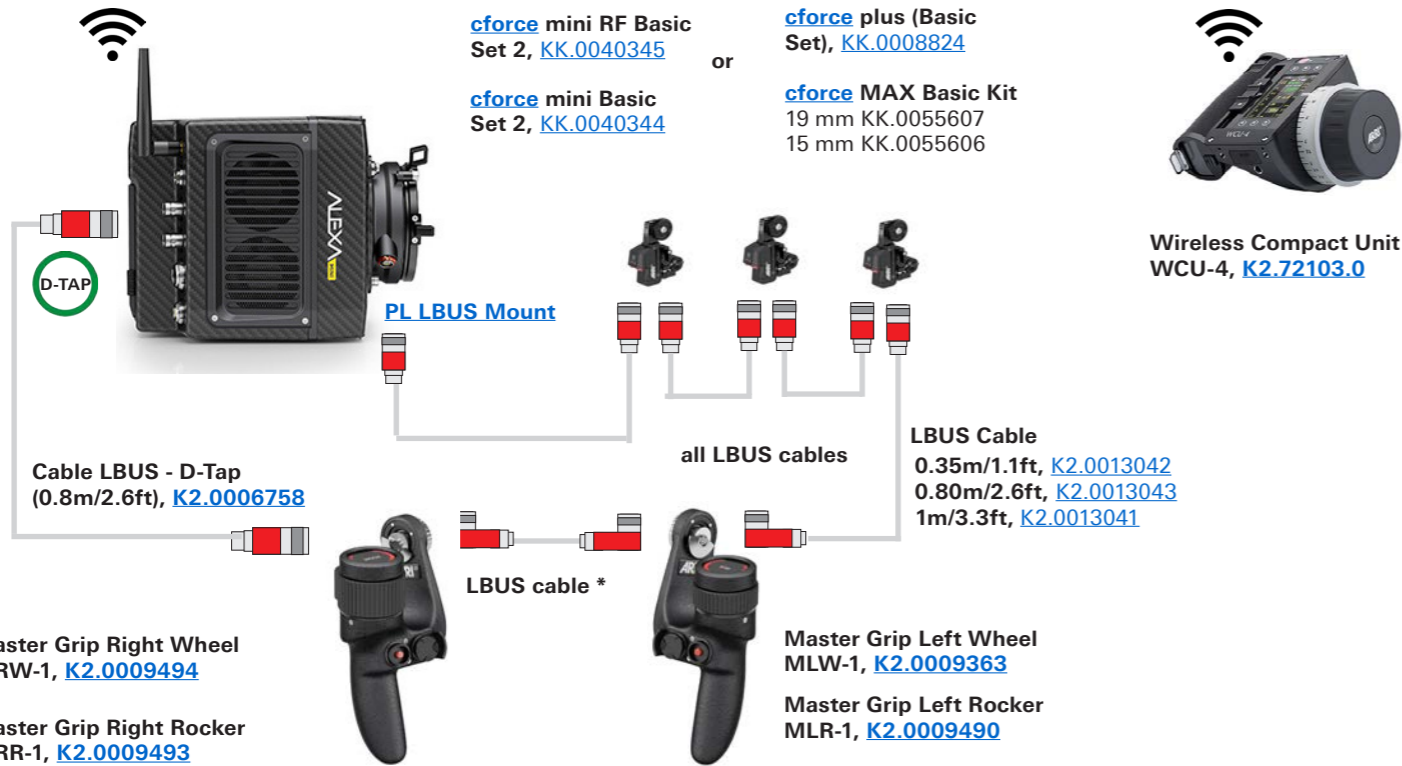

## ALEXA Mini - Servo Zoom Lens

Servo zoom control requires at least AMIRA/ALEXA Mini SUP 5.0

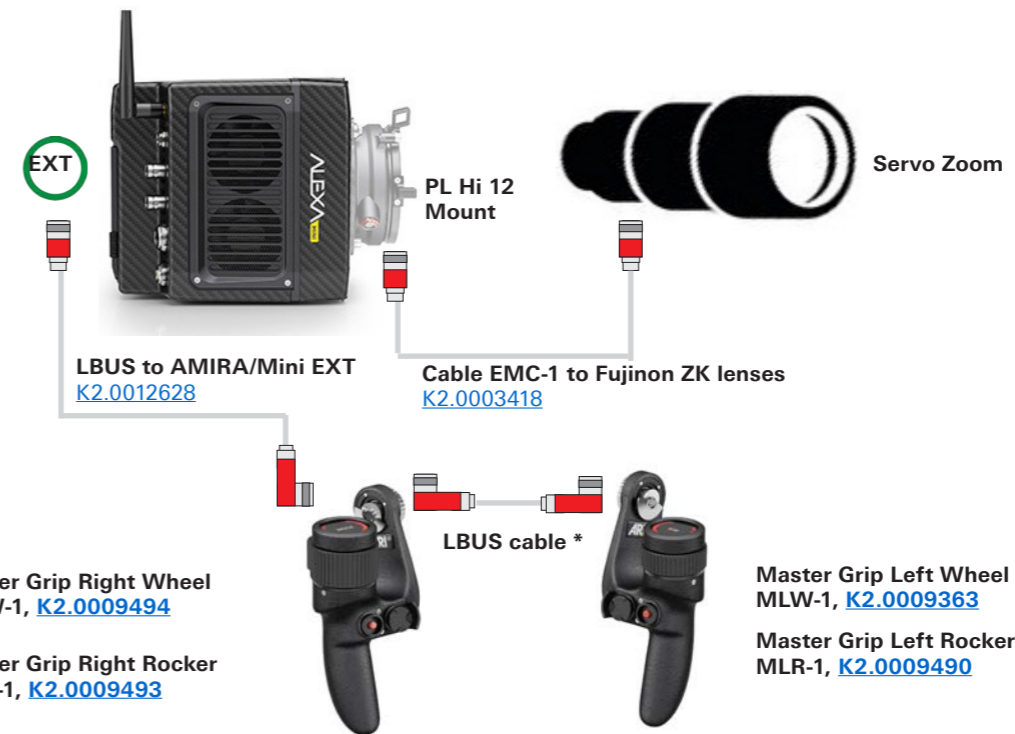

## ALEXA Mini - EF Lens

EF lens control requires at least AMIRA/ALEXA Mini SUP 5.0



## LBUS Cables



LBUS cables need to be ordered separately

**Cable LBUS (straight) to LBUS (straight) Length: 0.2m/8", [K2.0006749](#)**  
**Cable LBUS (straight) to LBUS (straight) Length: 0.3m/1ft, [K2.0006750](#)**  
**Cable LBUS (straight) to LBUS (straight) Length: 0.5m/1.5ft, [K2.0006751](#)**  
**Cable LBUS (straight) to LBUS (straight) Length: 0.8m/2.5ft, [K2.0006752](#)**  
**Cable LBUS (straight) to LBUS (straight) Length: 1.5m/5ft, [K2.0006753](#)**  
**Cable LBUS (straight) to LBUS (straight) Length: 3m/10ft, [K2.0006754](#)**  
**Cable LBUS (straight) to LBUS (straight) Length: 6m/20ft, [K2.0006755](#)**  
**Cable LBUS (straight) to LBUS (straight) Length: 15m/49ft, [K2.0006756](#)**  
**Cable LCS (5p) - LBUS (0.8m/2.6ft): [K2.0007318](#)**

**Cable LBUS (angled) to LBUS (straight) Length: 0.35m/1.1ft, [K2.0013042](#)**  
**Cable LBUS (angled) to LBUS (straight) Length: 0.80m/2.3ft, [K2.0013043](#)**  
**Cable LBUS (angled) to LBUS (straight) Length: 1m/3.3ft, [K2.0013041](#)**  
**Cable LBUS (angled) to LBUS (straight) Length: 0.3m/1", [K2.0051681](#)**  
**Cable LBUS (angled) to LBUS (angled) Length: 0.2m/8", [K2.0012785](#)**  
**Cable LBUS (angled) to LBUS (angled) Length: 0.6m/2ft, [K2.0013040](#)**  
**Cable LBUS (angled) to LBUS (angled) Length: 0.8m/2.6ft, [K2.0012630](#)**

**Cable LBUS Star (0.2m/8in). [K2.0023823](#)**

## Standard Grips & Extensions



# Operator Control Unit - Sample Configurations ALEXA Mini LF / ALEXA Mini



Configuration Overview | 4.4.0 / 2026.04

## ALEXA Mini LF / ALEXA Mini - Cine Style Lens

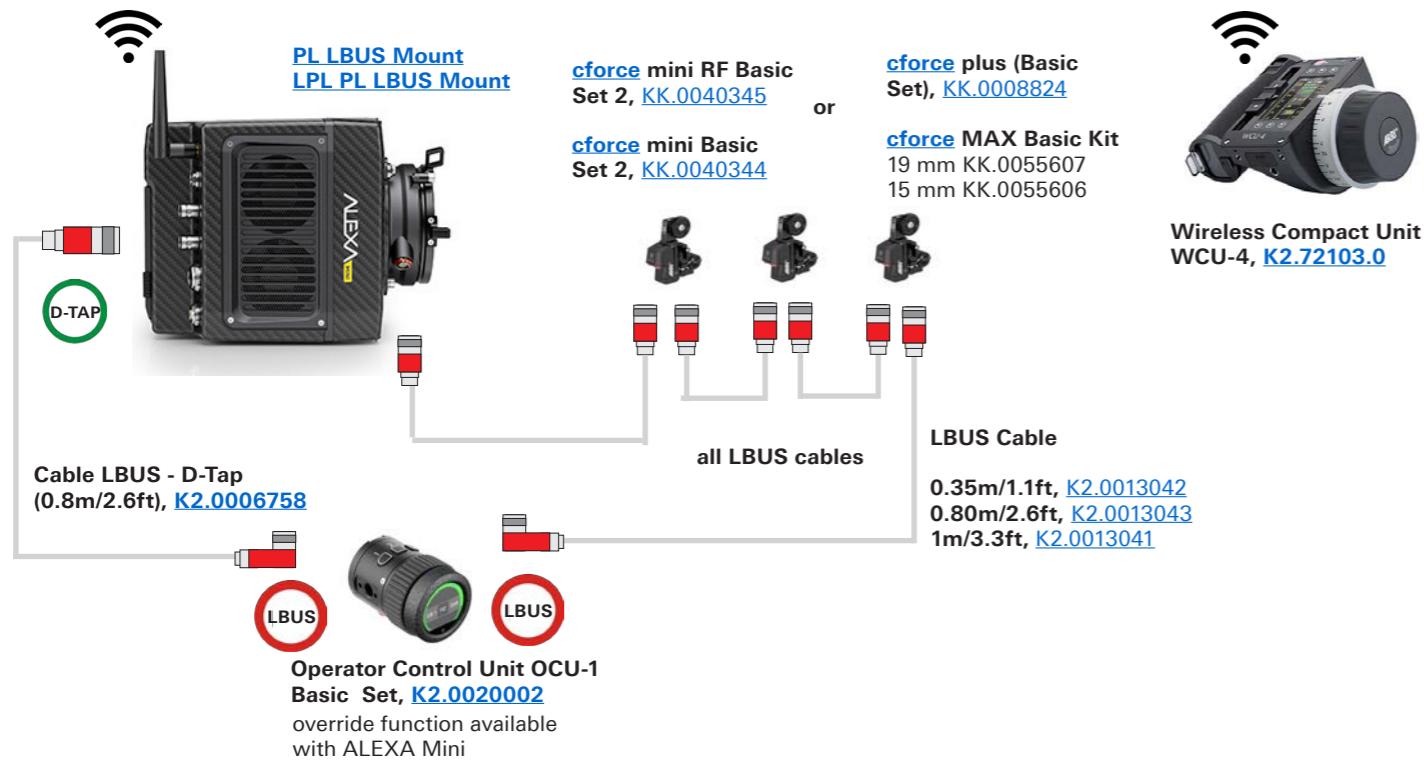

## ALEXA Mini LF / ALEXA Mini - Servo Zoom Lens

Servo zoom control requires AMIRA/ALEXA Mini SUP 5.0

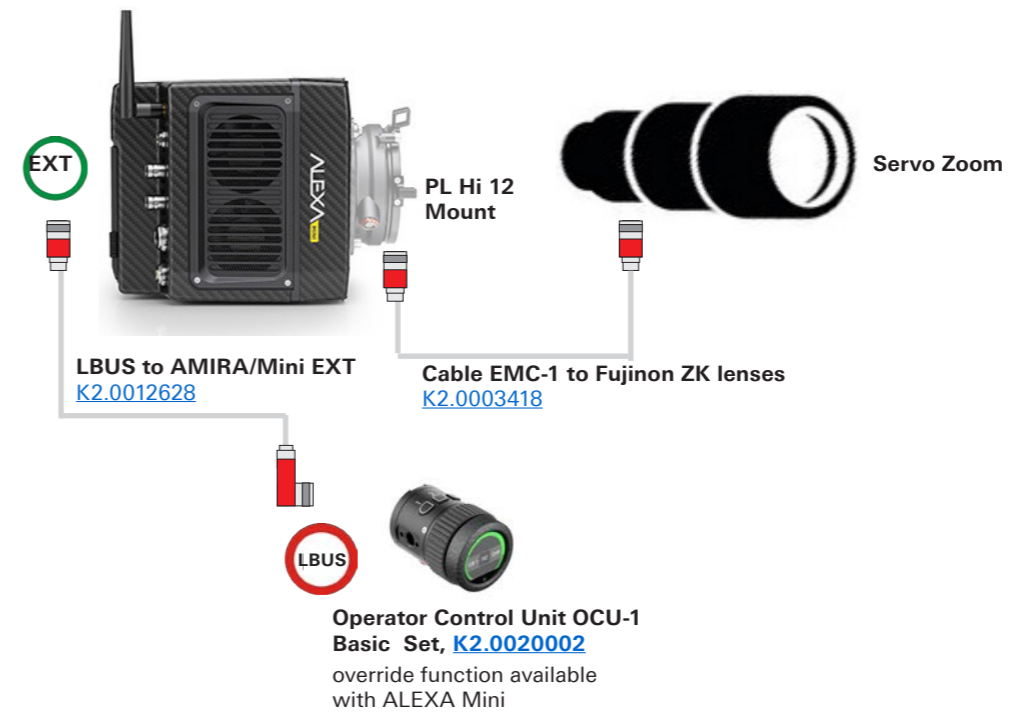

## ALEXA Mini LF / ALEXA Mini - EF Lens

EF lens control requires AMIRA/ALEXA Mini SUP 5.0



## LBUS Cables

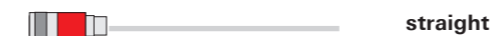

LBUS cables need to be ordered separately

- Cable LBUS (straight) to LBUS (straight) Length: 0.2m/8", [K2.0006749](#)
- Cable LBUS (straight) to LBUS (straight) Length: 0.3m/1ft, [K2.0006750](#)
- Cable LBUS (straight) to LBUS (straight) Length: 0.5m/1.5ft, [K2.0006751](#)
- Cable LBUS (straight) to LBUS (straight) Length: 0.8m/2.5ft, [K2.0006752](#)
- Cable LBUS (straight) to LBUS (straight) Length: 1.5m/5ft, [K2.0006753](#)
- Cable LBUS (straight) to LBUS (straight) Length: 3m/10ft, [K2.0006754](#)
- Cable LBUS (straight) to LBUS (straight) Length: 6m/20ft, [K2.0006755](#)
- Cable LBUS (straight) to LBUS (straight) Length: 15m/49ft, [K2.0006756](#)
- Cable LCS (5p) - LBUS (0.8m/2.6ft): [K2.0007318](#)

- Cable LBUS (angled) to LBUS (straight) Length: 0.35m/1.1ft, [K2.0013042](#)
- Cable LBUS (angled) to LBUS (straight) Length: 0.80m/2.3ft, [K2.0013043](#)
- Cable LBUS (angled) to LBUS (straight) Length: 1m/3.3ft, [K2.0013041](#)
- Cable LBUS (angled) to LBUS (straight) Length: 0.3m/1", [K2.0051681](#)
- Cable LBUS (angled) to LBUS (angled) Length: 0.2m/8", [K2.0012785](#)
- Cable LBUS (angled) to LBUS (angled) Length: 0.6m/2ft, [K2.0013040](#)
- Cable LBUS (angled) to LBUS (angled) Length: 0.8m/2.6ft, [K2.0012630](#)

Cable LBUS Star (0.2m/8in). [K2.0023823](#)

## Accessories

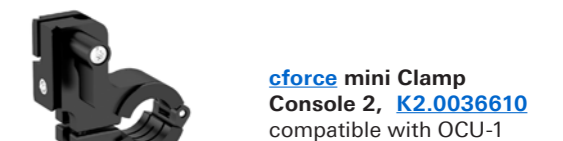
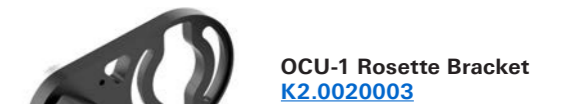

# Operator Control Unit - Sample Configurations ALEXA Mini LF / ALEXA Mini



Configuration Overview | 4.4.1 / 2026.04

## ALEXA Plus / Studio - Cine Style Lens

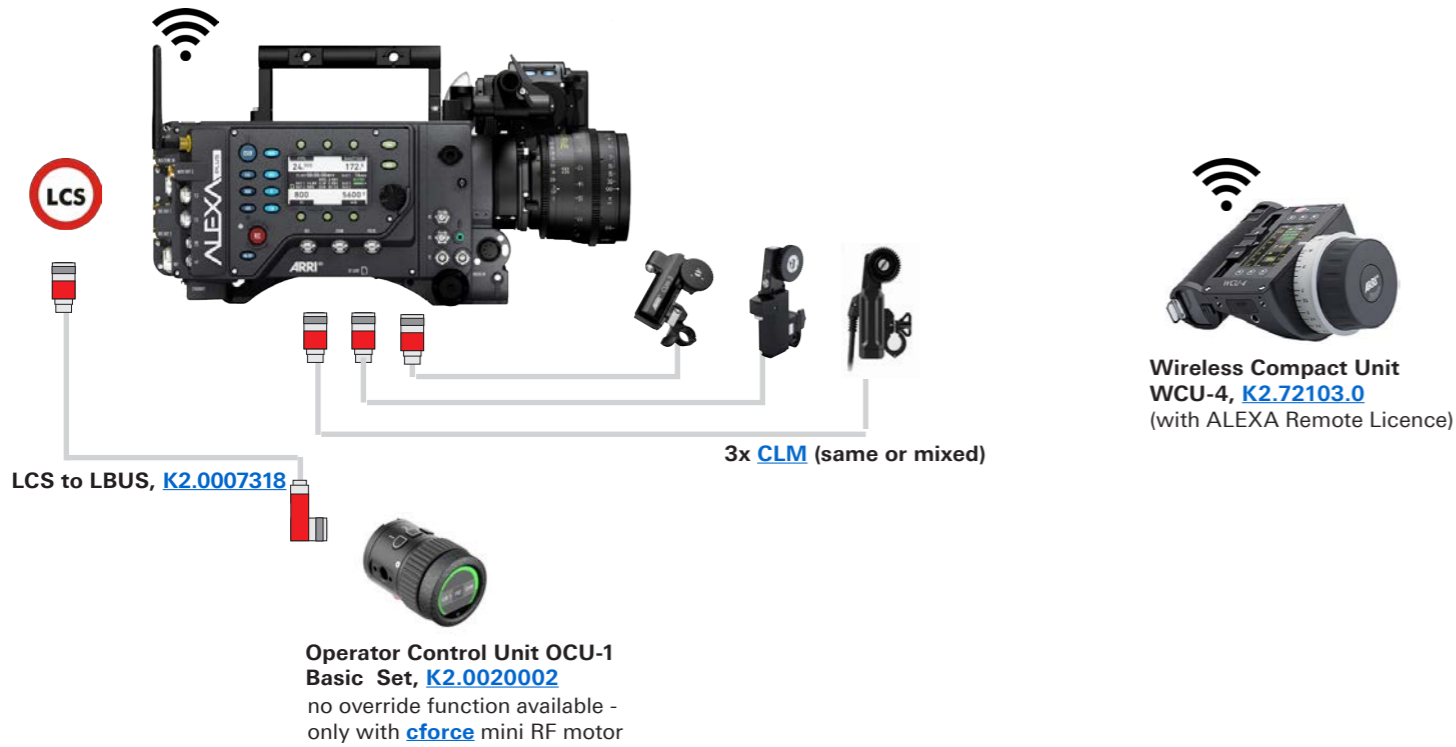

## ALEXA LF - Cine Style Lens

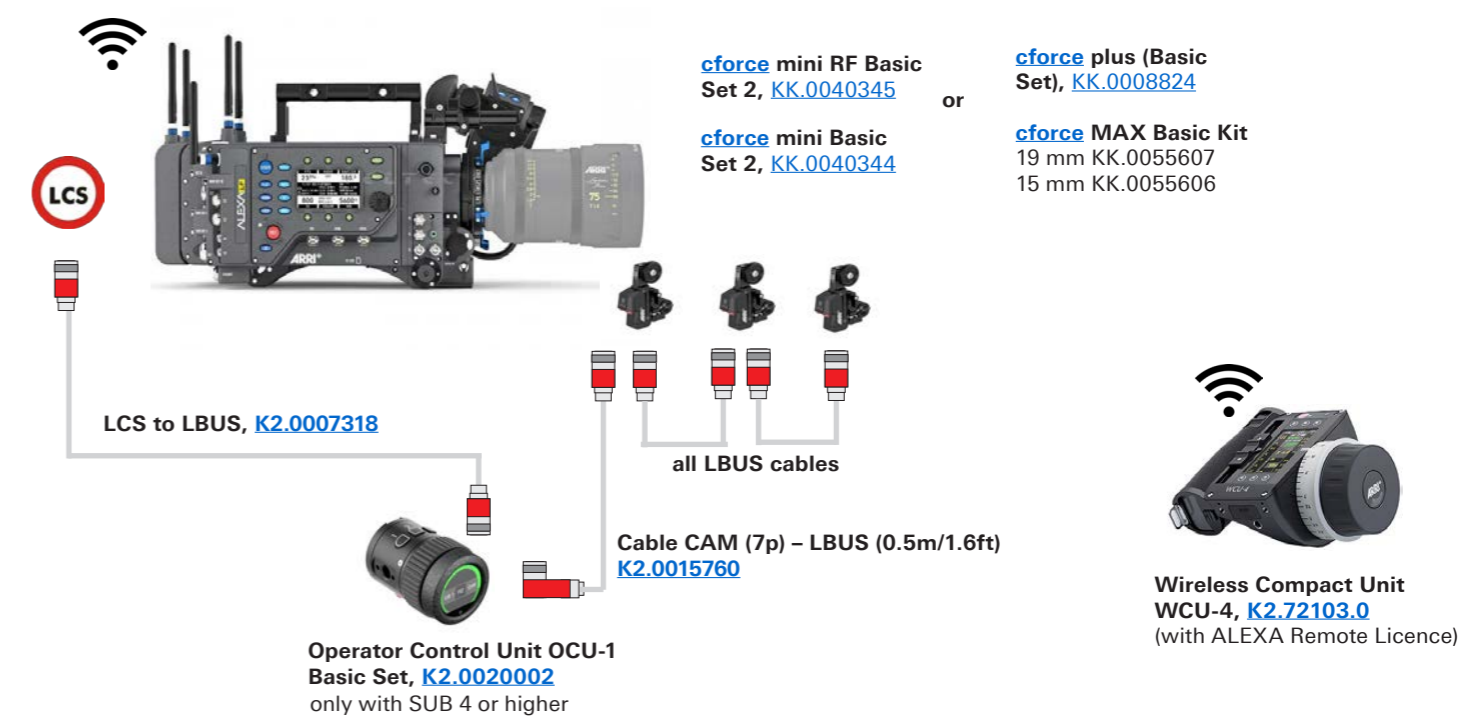

## LBUS Cables

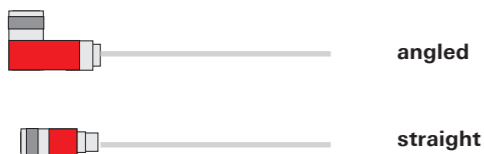

LBUS cables need to be ordered separately

Cable LBUS (straight) to LBUS (straight) Length: 0.2m/8", [K2.0006749](#)  
 Cable LBUS (straight) to LBUS (straight) Length: 0.3m/1ft, [K2.0006750](#)  
 Cable LBUS (straight) to LBUS (straight) Length: 0.5m/1.5ft, [K2.0006751](#)  
 Cable LBUS (straight) to LBUS (straight) Length: 0.8m/2.5ft, [K2.0006752](#)  
 Cable LBUS (straight) to LBUS (straight) Length: 1.5m/5ft, [K2.0006753](#)  
 Cable LBUS (straight) to LBUS (straight) Length: 3m/10ft, [K2.0006754](#)  
 Cable LBUS (straight) to LBUS (straight) Length: 6m/20ft, [K2.0006755](#)  
 Cable LBUS (straight) to LBUS (straight) Length: 15m/49ft, [K2.0006756](#)  
 Cable LCS (5p) - LBUS (0.8m/2.6ft): [K2.0007318](#)

Cable LBUS (angled) to LBUS (straight) Length: 0.35m/1.1ft, [K2.0013042](#)  
 Cable LBUS (angled) to LBUS (straight) Length: 0.80m/2.3ft, [K2.0013043](#)  
 Cable LBUS (angled) to LBUS (straight) Length: 1m/3.3ft, [K2.0013041](#)  
 Cable LBUS (angled) to LBUS (straight) Length: 0.3m/1", [K2.0051681](#)  
 Cable LBUS (angled) to LBUS (angled) Length: 0.2m/8", [K2.0012785](#)  
 Cable LBUS (angled) to LBUS (angled) Length: 0.6m/2ft, [K2.0013040](#)  
 Cable LBUS (angled) to LBUS (angled) Length: 0.8m/2.6ft, [K2.0012630](#)

Cable LBUS Star (0.2m/8in). [K2.0023823](#)

## Accessories



## ALEXA EV - Cine Style Lens

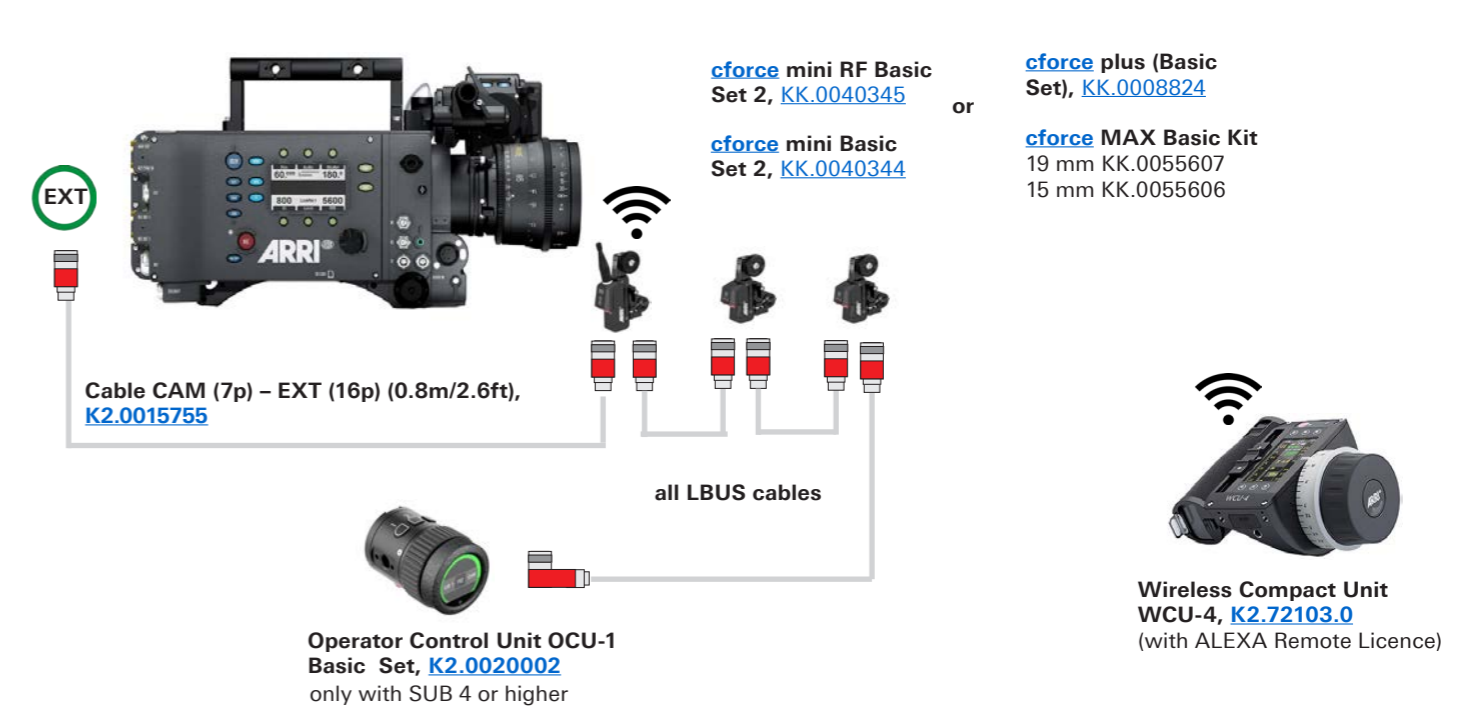

# Operator Control Unit - Sample Configurations AMIRA



Configuration Overview | 4.4.2 / 2026.04

## AMIRA - Cine Style Lens



## AMIRA - Servo Zoom Lens

Servo zoom control requires AMIRA/ALEXA Mini SUP 5.0 or higher

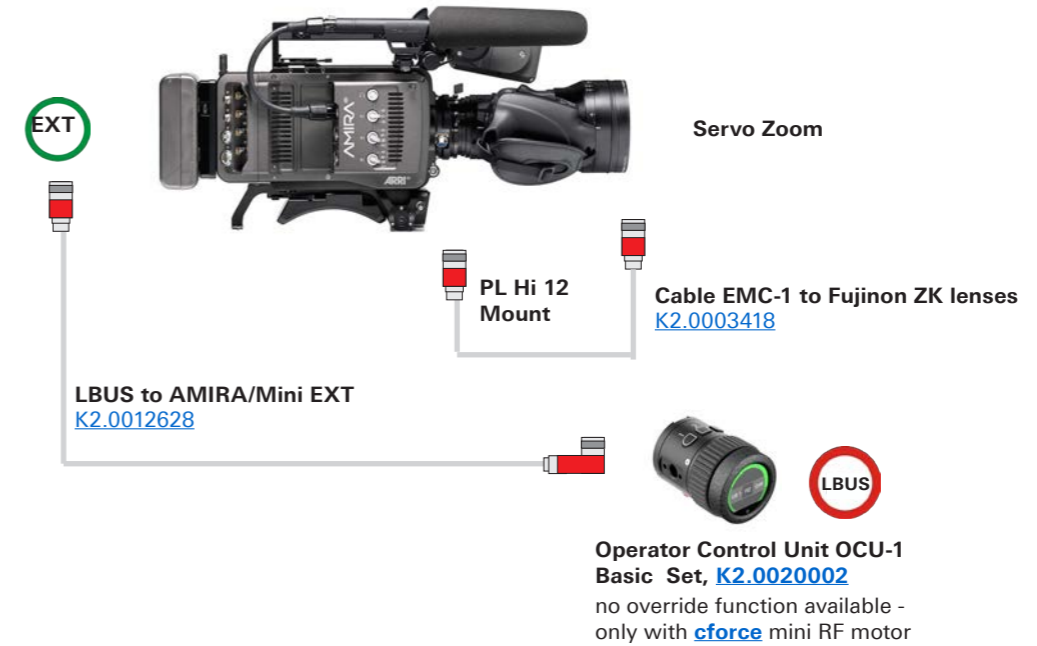

## AMIRA - EF Lens

EF lens control requires AMIRA/ALEXA Mini SUP 5.0 or higher



\* For Extensions 80 and 160 mm length we suggest:  
Cable LBUS (angled) to LBUS (angled)  
Length: 0.6m/2ft, [K2.0013040](#)  
\* For Extensions 240 mm length we suggest:  
Cable LBUS (angled) to LBUS (angled)  
Length: 0.8m/2.6ft, [K2.0012630](#)

## LBUS Cables

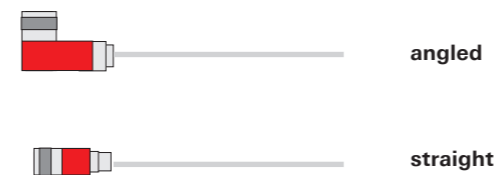

LBUS cables need to be ordered separately

Cable LBUS (straight) to LBUS (straight) Length: 0.2m/8", [K2.0006749](#)  
Cable LBUS (straight) to LBUS (straight) Length: 0.3m/1ft, [K2.0006750](#)  
Cable LBUS (straight) to LBUS (straight) Length: 0.5m/1.5ft, [K2.0006751](#)  
Cable LBUS (straight) to LBUS (straight) Length: 0.8m/2.5ft, [K2.0006752](#)  
Cable LBUS (straight) to LBUS (straight) Length: 1.5m/5ft, [K2.0006753](#)  
Cable LBUS (straight) to LBUS (straight) Length: 3m/10ft, [K2.0006754](#)  
Cable LBUS (straight) to LBUS (straight) Length: 6m/20ft, [K2.0006755](#)  
Cable LBUS (straight) to LBUS (straight) Length: 15m/49ft, [K2.0006756](#)  
Cable LCS (5p) - LBUS (0.8m/2.6ft): [K2.0007318](#)

Cable LBUS (angled) to LBUS (straight) Length: 0.35m/1.1ft, [K2.0013042](#)  
Cable LBUS (angled) to LBUS (straight) Length: 0.80m/2.3ft, [K2.0013043](#)  
Cable LBUS (angled) to LBUS (straight) Length: 1m/3.3ft, [K2.0013041](#)  
Cable LBUS (angled) to LBUS (straight) Length: 0.3m/1", [K2.0051681](#)  
Cable LBUS (angled) to LBUS (angled) Length: 0.2m/8", [K2.0012785](#)  
Cable LBUS (angled) to LBUS (angled) Length: 0.6m/2ft, [K2.0013040](#)  
Cable LBUS (angled) to LBUS (angled) Length: 0.8m/2.6ft, [K2.0012630](#)

Cable LBUS Star (0.2m/8in). [K2.0023823](#)

## Accessories



# Operator Control Unit - Sample Configurations 3rd Party Camera



Configuration Overview | 4.4.3 / 2026.04

## 3rd Party Camera - Cine Lens

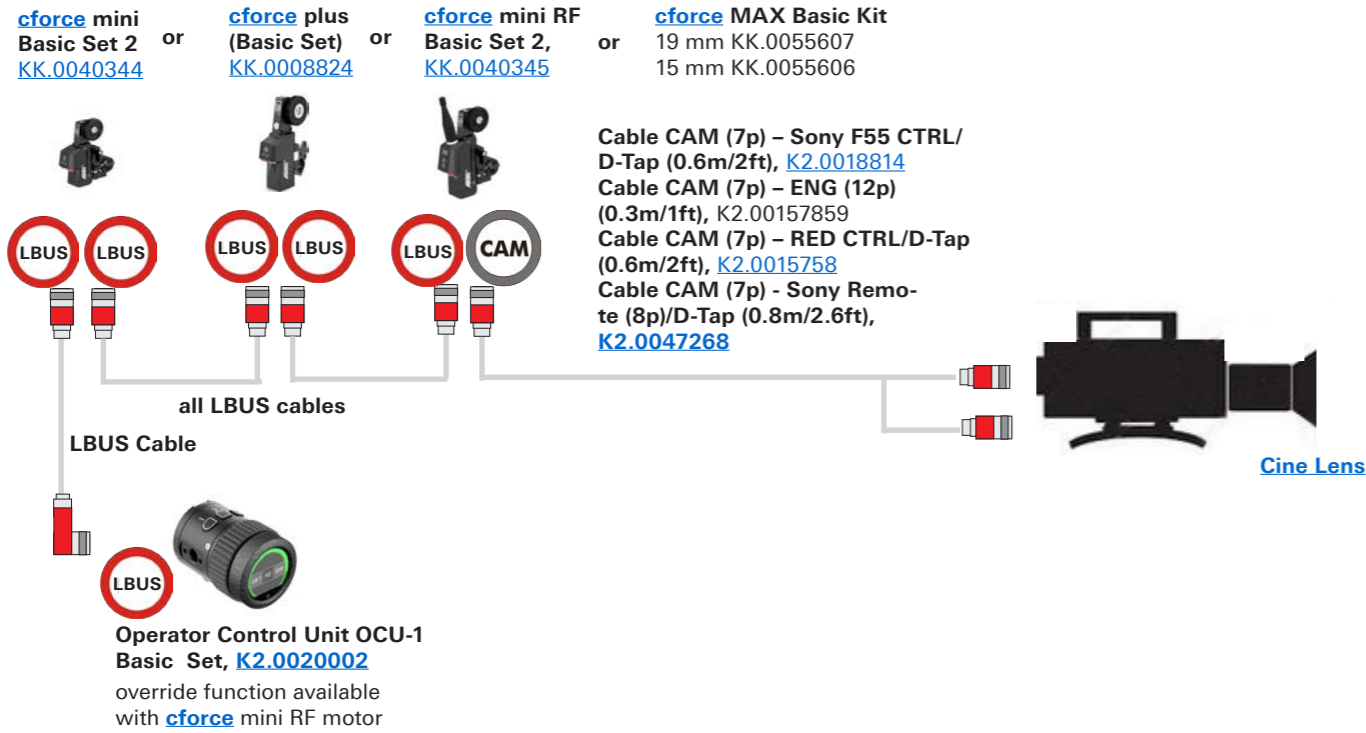

## 3rd Party Camera - Cine Lens

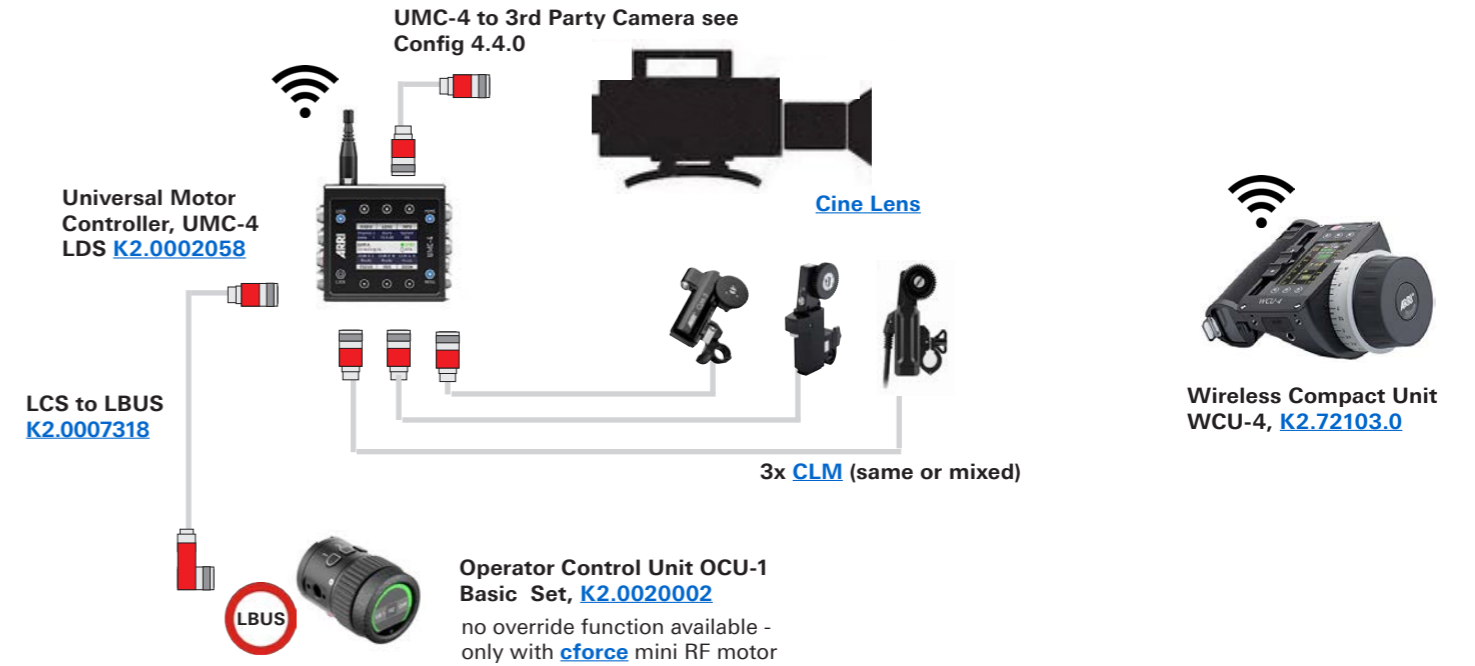

## LBUS Cables



LBUS cables need to be ordered separately

- Cable LBUS (straight) to LBUS (straight) Length: 0.2m/8", [K2.0006749](#)
- Cable LBUS (straight) to LBUS (straight) Length: 0.3m/1ft, [K2.0006750](#)
- Cable LBUS (straight) to LBUS (straight) Length: 0.5m/1.5ft, [K2.0006751](#)
- Cable LBUS (straight) to LBUS (straight) Length: 0.8m/2.5ft, [K2.0006752](#)
- Cable LBUS (straight) to LBUS (straight) Length: 1.5m/5ft, [K2.0006753](#)
- Cable LBUS (straight) to LBUS (straight) Length: 3m/10ft, [K2.0006754](#)
- Cable LBUS (straight) to LBUS (straight) Length: 6m/20ft, [K2.0006755](#)
- Cable LBUS (straight) to LBUS (straight) Length: 15m/49ft, [K2.0006756](#)
- Cable LCS (5p) - LBUS (0.8m/2.6ft): [K2.0007318](#)

- Cable LBUS (angled) to LBUS (straight) Length: 0.35m/1.1ft, [K2.0013042](#)
- Cable LBUS (angled) to LBUS (straight) Length: 0.80m/2.3ft, [K2.0013043](#)
- Cable LBUS (angled) to LBUS (straight) Length: 1m/3.3ft, [K2.0013041](#)
- Cable LBUS (angled) to LBUS (straight) Length: 0.3m/1", [K2.0051681](#)
- Cable LBUS (angled) to LBUS (straight) Length: 0.2m/8", [K2.0012785](#)
- Cable LBUS (angled) to LBUS (angled) Length: 0.6m/2ft, [K2.0013040](#)
- Cable LBUS (angled) to LBUS (angled) Length: 0.8m/2.6ft, [K2.0012630](#)

Cable LBUS Star (0.2m/8in). [K2.0023823](#)

## Accessories

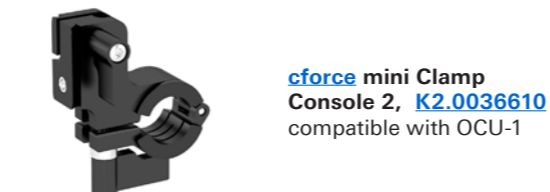

## 3rd Party Camera - Servo Zoom Lens

Servo zoom control requires AMIRA/ALEXA Mini SUP 5.0 and higher

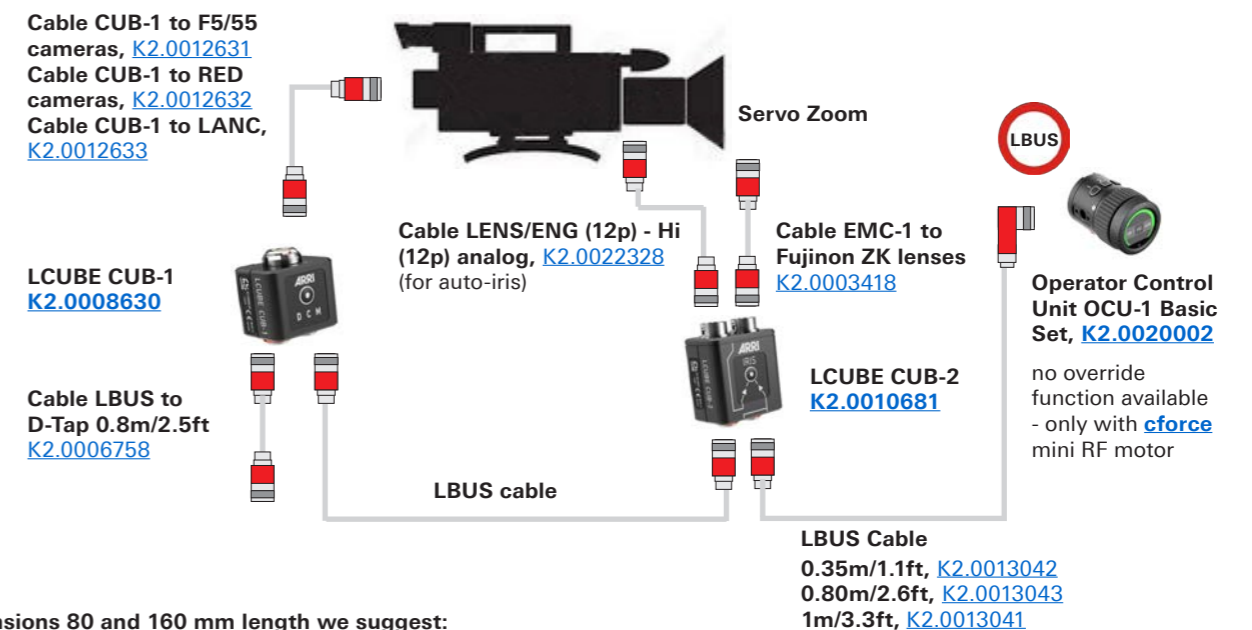

- \* For Extensions 80 and 160 mm length we suggest:  
 Cable LBUS (angled) to LBUS (angled) Length: 0.6m/2ft, [K2.0013040](#)
- \* For Extensions 240 mm length we suggest:  
 Cable LBUS (angled) to LBUS (angled) Length: 0.8m/2.6ft, [K2.0012630](#)

# cforce mini RF - Sample Configuration



Configuration Overview | 4.5.0 / 2026.04

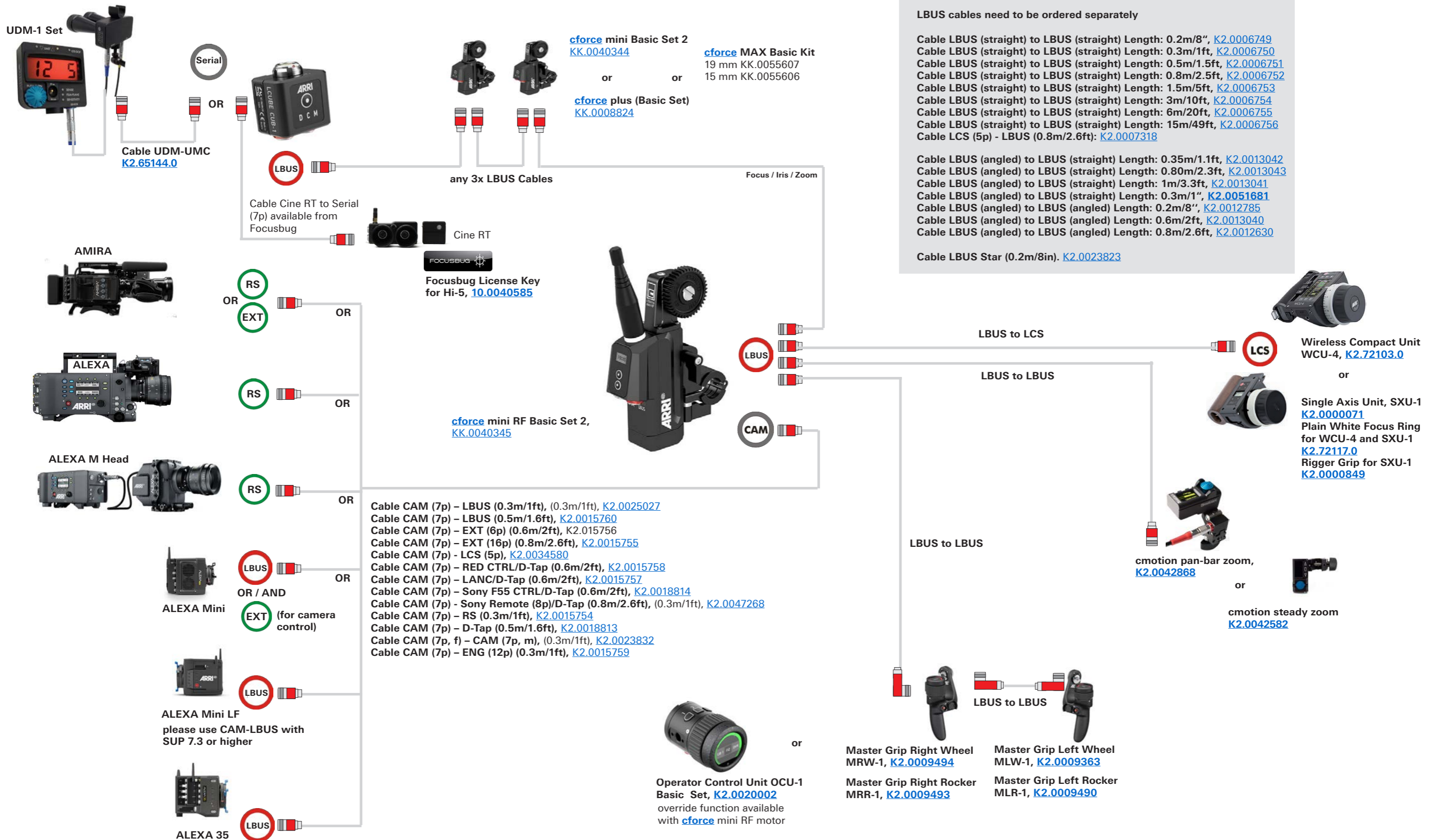

# cforce mini RF - Cable Guide



Configuration Overview | 4.5.1 / 2025.10

Item Number	Cable Name	Supported Cameras	Camera Control		
			Run/Stop?	on Hi-5	on WCU-4
<a href="#">K2.0025027</a>	Cable CAM (7p) – LBUS (0.3m/1ft)	ALEXA 35, or when using a <a href="#">cforce</a> mini RF motor in CLIENT mode in a daisy chain with other <a href="#">cforce</a> motors.	Yes	Yes	Yes
<a href="#">K2.0015760</a>	Cable CAM (7p) – LBUS (0.5m/1.6ft)	ALEXA 35, or when using a <a href="#">cforce</a> mini RF motor in CLIENT mode in a daisy chain with other <a href="#">cforce</a> motors.	Yes	Yes	Yes
<a href="#">K2.0015756</a>	Cable CAM (7p) – EXT (6p) (0.6m/2ft)	ALEXA Mini, ALEXA Mini LF, AMIRA	Yes	Yes	Yes
<a href="#">K2.0015755</a>	Cable CAM (7p) – EXT (16p) (0.8m/2.6ft)	ALEXA Classic EV, ALEXA XT EV, ALEXA SXT EV. Only works with ALEXA EV cameras, not ALEXA Plus	Yes	Yes	Yes
<a href="#">K2.0034580</a>	Cable CAM (7p) - LCS (5p) (0.8m/2.6ft)	ALEXA Plus cameras including ALEXA Plus, ALEXA XT Plus, ALEXA SXT Plus, ALEXA LF, ALEXA 65	Yes	Yes	Yes
<a href="#">K2.0015758</a>	Cable CAM (7p) – RED CTRL/D-Tap (0.6m/2ft)	RED DSMC2 cameras except those with Base Expander Module. RED DSMC3 cameras (Komodo/V-Raptor) with module or break-out cable from 9p Lemo EXT Connector to RED CTRL connector. Supports run/stop/tally on WCU-4 and Hi-5. Additional RED Camera Control License Key required for further camera control on Hi-5	Yes	Yes	No
<a href="#">K2.0015757</a>	Cable CAM (7p) – LANC/D-Tap (0.6m/2ft)	Many cameras with a LANC connector including Canon C300/C500 series, Sony PXW-FX9/FS7 and Blackmagic Ursa Mini Pro	Yes	No	No
<a href="#">K2.0018814</a>	Cable CAM (7p) – Sony Venice/F55 CTRL/D-Tap (0.6m/2ft)	Sony F5/F55 and Sony Venice. Not compatible with Sony Venice 2, Panasonic Varicam, Panasonic Vari-cam LT	Yes	No	No
<a href="#">K2.0047268</a>	Cable CAM (7p) - Sony Remote (8p)/D-Tap (0.8m/2.6ft)	Run/stop/tally for Sony Venice and Venice 2. Additional camera control supported on Hi-5 with Sony Camera Control License Key for Hi-5	Yes	Yes	No
<a href="#">K2.0015754</a>	Cable CAM (7p) – RS (0.3m/1ft)	Run/stop/tally on all ARRI Cameras and any camera that supports run/stop via a 3p Fischer connector. Can also be used to supply additional power to an LBUS chain	Yes	No	No
<a href="#">K2.0018813</a>	Cable CAM (7p) – D-Tap (0.5m/1.6ft)	For adding additional power into an LBUS system, or for powering the <a href="#">cforce</a> mini RF without any camera connection	No	No	No
<a href="#">K2.0023832</a>	Cable CAM (7p, f) – CAM (7p, m) (0.3m/1ft)	Extension cable for any CAM cable	N/A	N/A	N/A
<a href="#">K2.0015759</a>	Cable CAM (7p) – ENG (12p) (0.3m/1ft)	Broadcast cameras that feature a 12p Hirose Lens connector. Required for remote iris control by Sony or Skaarhoj RCP. Can also be used to inject lens metadata into Sony Venice LENS connector.	N/A	N/A	N/A

Note: Sony and RED Camera Control Licenses required for camera control on Hi-5. ALEXA Remote License Key required for ALEXA/AMIRA camera control on WCU-4.

### cforce mini



**cforce mini Basic Set 2**  
KK.0040344

**cforce mini Motor Unit**  
K2.0006354

**cforce mini Clamp Console 2**  
19/15mm, K2.0036610

**CLM-5/cforce mini Gear**  
m0.8/32p, 40t, K2.0003753

**LBUS** **LBUS**

### cforce plus



**cforce plus Motor Unit**, K2.0008819

**cforce plus Clamp Console**  
19/15 mm, K2.0008678

**cforce plus (Basic Set)**  
KK.0008824

**cforce plus Gear** m0.8/32p, 60t,  
K2.0009335

**LBUS** **LBUS**

### cforce MAX



**cforce MAX Motor Unit**, K2.0055211

**Motor Rod Clamp MRC-1**  
19 mm K2.0053386  
15 mm K2.0055222

**cforce MAX Basic Kit**  
19 mm KK.0055607  
15 mm KK.0055606

**CLM-4/cforce Gear**  
m0.8/32p, 50t, K2.72108.0

**LBUS** **LBUS**

### cforce mini RF



**cforce mini RF Motor Unit**  
K2.0016802

**cforce mini Clamp Console 2**  
19/15mm, K2.0036610

**CLM-5/cforce mini Gear**  
m0.8/32p, 40t, K2.0003753

**Outdoor Antenna, straight, for UMC-4 Motor Controller**,  
K2.0002007

**LBUS** **CAM**

### cforce mini / MAX & CLM-5 Accessories

**CLM-5/cforce mini Clamp Console** 19/15mm,  
K2.0006176

**CLM-5/cforce mini Clamp Insert** 19/15mm (incl. in  
K2.0006176) K2.0006175

**cforce mini Clamp Console 2** 19/15mm  
K2.0036610

**Motor Rod Clamp MRC-1**  
19 mm K2.0053386  
15 mm K2.0055222

**cforce mini Clamp Insert 2** 15mm  
K2.0038503

**cforce mini Clamp Insert 2** 5/8in  
K2.0038504

**CLM-5/cforce mini Gear** m0.8/32p, 40t, K2.0003753  
**CLM-5/cforce mini Gear** m0.8, 40t, 25 mm, K2.0006372  
**CLM-5/cforce mini Gear** m0.4/64p, 80t, K2.0006367  
**CLM-5/cforce mini Gear** m0.5, 64t, K2.0006365  
**CLM-5/cforce mini Gear** m0.6, 56t, K2.0006363  
**CLM-5/cforce mini Gear** 48p, 60t, K2.0006370

**CLM-4/cforce Gear** m0.8/32p, 50t, K2.72108.0  
**CLM-4/cforce Gear** m0.8, 50t, 25mm, K2.72112.0

### cforce plus / MAX & CLM-4 Accessories

**CLM-4 Rod-to-Rod Adapter** 15mm, K2.72106.0

**CLM-4 Rod-to-Rod Bridge Adapter** 15mm, K2.72107.0

**Motor Rod Clamp MRC-1**  
19 mm K2.0053386  
15 mm K2.0055222

**CLM-4 Rosette Adapter for Hill Bracket**, K2.72113.0

**Gear Screw for CLM-4**  
K2.72127.0

**CLM-4/cforce plus Gear assembly with modul**  
0.6, 70 teeth, K2.72111.0

**CLM-4/cforce plus Gear assembly with 48 pitch,**  
75 teeth, K2.0002044

**CLM-4/cforce plus Gear assembly with module**  
0.5, 80 teeth, K2.72110.0

**CLM-4/cforce plus Gear assembly with module**  
0.4/64 pitch, 100 teeth, K2.72109.0

### LBUS / CAM Cables

LBUS cables need to be ordered separately

LBUS (straight) to LBUS (straight) Length: 0.2m/8", K2.0006749  
LBUS (straight) to LBUS (straight) Length: 0.3m/1ft, K2.0006750  
LBUS (straight) to LBUS (straight) Length: 0.5m/1.5ft, K2.0006751  
LBUS (straight) to LBUS (straight) Length: 0.8m/2.5ft, K2.0006752  
LBUS (straight) to LBUS (straight) Length: 1.5m/5ft, K2.0006753  
LBUS (straight) to LBUS (straight) Length: 3m/10ft, K2.0006754  
LBUS (straight) to LBUS (straight) Length: 6m/20ft, K2.0006755  
LBUS (straight) to LBUS (straight) Length: 15m/49ft, K2.0006756  
LCS (5p) - LBUS (0.8m/2.6ft): K2.0007318

LBUS (angled) to LBUS (straight) Length: 0.35m/1.1ft, K2.0013042  
LBUS (angled) to LBUS (straight) Length: 0.80m/2.3ft, K2.0013043  
LBUS (angled) to LBUS (straight) Length: 1m/3.3ft, K2.0013041  
LBUS (angled) to LBUS (angled) Length: 0.2m/8", K2.0012785  
LBUS (angled) to LBUS (angled) Length: 0.6m/2ft, K2.0013040  
LBUS (angled) to LBUS (angled) Length: 0.8m/2.6ft, K2.0012630  
LBUS Star (0.2m/8in). K2.0023823

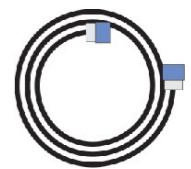

Cable CAM (7p) – RS (0.3m/1ft), K2.0015754  
Cable CAM (7p) – EXT (16p) (0.8m/2.6ft), K2.0015755  
Cable CAM (7p) – EXT (6p) (0.6m/2ft), K2.0015756  
Cable CAM (7p) – LANC/D-Tap (0.6m/2ft), K2.0015757  
Cable CAM (7p) – RED CTRL/D-Tap (0.6m/2ft), K2.0015758  
Cable CAM (7p) – ENG (12p) (0.3m/1ft), K2.0015759  
Cable CAM (7p) – LBUS (0.5m/1.6ft), K2.0015760  
Cable CAM (7p) – Sony F55 CTRL/D-Tap (0.6m/2ft), K2.0018814  
Cable CAM (7p) – D-Tap (0.5m/1.6ft), K2.0018813  
Cable CAM (7p, f) – CAM (7p, m), (0.3m/1ft), K2.0023832  
Cable CAM (7p) – LBUS (0.3m/1ft), (0.3m/1ft), K2.0025027

Lens Type	Focus Gear	Iris Gear	Zoom Gear
CINE	Module 0.8 / 32 pitch	Module 0.8 / 32 pitch	Module 0.8 / 32 pitch
Panavision	Module 0.8 / 32 pitch	Module 0.4 / 64 pitch	48 pitch (no common pitch equivalent)
Fujifilm B4 ENG	Module 0.6 (no common pitch equivalent)	Module 0.4 / 64 pitch	Modul 0.6 (no common pitch equivalent)
Canon B4 ENG	Module 0.5 (no common pitch equivalent)	Module 0.4 / 64 pitch	Modul 0.5 (no common pitch equivalent)

## Configuration Overview | 4.5.3 / 2025.10

### CLM-4 & Accessories



**Controlled Lens Motor CLM-4 (Set)**  
[KK.0005855](#)



**Cable for CLM-4 Motor,** [K2.72099.0](#)



**CLM-4 Gear Set**  
0.8, 0.6, 0.5, 0.4,  
[K2.72116.0](#)  
(incl. one metal core)



**Standard Clamp Console for CLM-4**  
[K2.72101.0](#)



**Standard Clamp Console for CLM-3**  
[K2.65140.0](#)



**Clamp Console-2 for CLM-3**  
[K2.65141.0](#)



**19 mm to 15 mm insert for CLM-4,** [K2.0002080](#)



**CLM-4 Clamp Insert 5/8"**  
[K2.72115.0](#)



**Gear Flange for CLM-4**  
[K2.0000244](#)



**CLM-4 Gear assembly with modul 0.8/32 pitch, 50 teeth (incl. metal gear Flange),** [K2.72108.0](#)



**CLM-4 Gear assembly with modul 0.8/32 pitch, 50 teeth, 25mm extra wide** [K2.72112.0](#)

### CLM-5 \*\* & Accessories

**\*\* phase out - sales only as long as stock is available**



**CLM-5 Motor Unit\*\***  
[K2.0006360](#)



**CLM-5/cforce mini Clamp Console 19/15mm,**  
[K2.0006176](#)



**CLM-5/cforce mini Gear m0.8/32p, 40t,** [K2.0003753](#)



**CLM-5 Motor Cable,**  
[K2.0006332](#)



**CLM-5\*\* (Basic Set)**  
[K2.0006361](#)

### CLM-5\*\* / cforce mini Accessories

**\*\* phase out - sales only as long as stock is available**



**CLM-5/cforce mini Clamp Console 19/15mm,**  
[K2.0006176](#)



**CLM-5/cforce mini Clamp Insert 19/15mm (incl. in [K2.0006176](#))** [K2.0006175](#)



**CLM-5/cforce mini Gear m0.8/32p, 40t,** [K2.0003753](#)  
**CLM-5/cforce mini Gear m0.8, 40t, 25 mm,** [K2.0006372](#)  
**CLM-5/cforce mini Gear m0.4/64p, 80t,** [K2.0006367](#)  
**CLM-5/cforce mini Gear m0.5, 64t,** [K2.0006365](#)  
**CLM-5/cforce mini Gear m0.6, 56t,** [K2.0006363](#)  
**CLM-5/cforce mini Gear 48p, 60t,** [K2.0006370](#)

### CLM-3\*\* & Accessories

**\*\* phase out - sales only as long as stock is available**



**Controlled Lens Motor CLM-3 (Set)\*\*** [KK.0005854](#)



**CLM-3 Motor Unit\*\***  
[K2.65143.0](#)



**Cable for CLM-3 Motor,** [K2.65145.0](#)



**Gear for Cine Lenses Module 0.8, 60 teeth for CLM-3,** [K2.65142.0](#)



**Standard Clamp Console for CLM-3**  
[K2.65140.0](#)



**Clamp Console-2 for CLM-3**  
[K2.65141.0](#)



**19 mm to 15 mm inserts for CLM-3 (pair),**  
[K2.0002077](#)



**CLM-3 gear module 0.8/32 pitch, 60 teeth,** [K2.65142.0](#)



**CLM-3 gear module, 0.8/32 pitch, 60 teeth, 25mm extra-wide,** [K2.0001256](#)



**CLM-3 gear module 0.6, 84 teeth,** [K2.0001918](#)



**CLM-3 gear module with 48 pitch, 90 teeth,** [K2.0002055](#)



**CLM-3 gear module 0.5, 96 teeth,** [K2.0001914](#)



**CLM-3 gear module 0.4/64 pitch, 120 teeth,** [K2.0001911](#)

### LDE-1 Lens Data Encoder\*\*

**\*\* phase out - sales only as long as stock is available**



**Lens Data Encoder LDE-1\*\*,** [K2.0002680](#)



**LDE-1 Cable**  
[K2.0003040](#)



**LDE-1 Gear m0.8/32p, 60t,** [K2.0003036](#)  
For standard cine lenses focus/iris/zoom, Panavision focus only.



**LDE-1 Gear m0.4/64p, 120t,** [K2.0003050](#)  
For Panavision iris, Fujinon ENG iris, Canon ENG iris.



**LDE-1 Gear 48p, 90t,** [K2.0003052](#)  
For Panavision zoom.

### CLM-4 / cforce plus Accessories



**cforce plus Rod-to-Rod Adapter 15mm,** [K2.72106.0](#)



**cforce plus Rod-to-Rod Bridge 15mm,** [K2.72107.0](#)



**CLM-4 Rosette Adapter for Hill Bracket,** [K2.72113.0](#)



**CLM-4, cforce plus Gear Screw,** [K2.72127.0](#)



**CLM-4 Gear assembly with modul 0.6, 70 teeth,** [K2.72111.0](#)



**CLM-4 Gear assembly with 48 pitch, 75 teeth,** [K2.0002044](#)



**CLM-4 Gear assembly with module 0.5, 80 teeth,** [K2.72110.0](#)



**CLM-4 Gear assembly with module 0.4/64 pitch, 100 teeth,**  
[K2.72109.0](#)

Lens Type	Focus Gear	Iris Gear	Zoom Gear
CINE	Module 0.8 / 32 pitch	Module 0.8 / 32 pitch	Module 0.8 / 32 pitch
Panavision	Module 0.8 / 32 pitch	Module 0.4 / 64 pitch	48 pitch (no common pitch equivalent)
Fujifilm B4 ENG	Module 0.6 (no common pitch equivalent)	Module 0.4 / 64 pitch	Module 0.6 (no common pitch equivalent)
Canon B4 ENG	Module 0.5 (no common pitch equivalent)	Module 0.4 / 64 pitch	Module 0.5 (no common pitch equivalent)

# Universal Motor Controller UMC-4



Configuration Overview | 4.6.0 / 2025.10

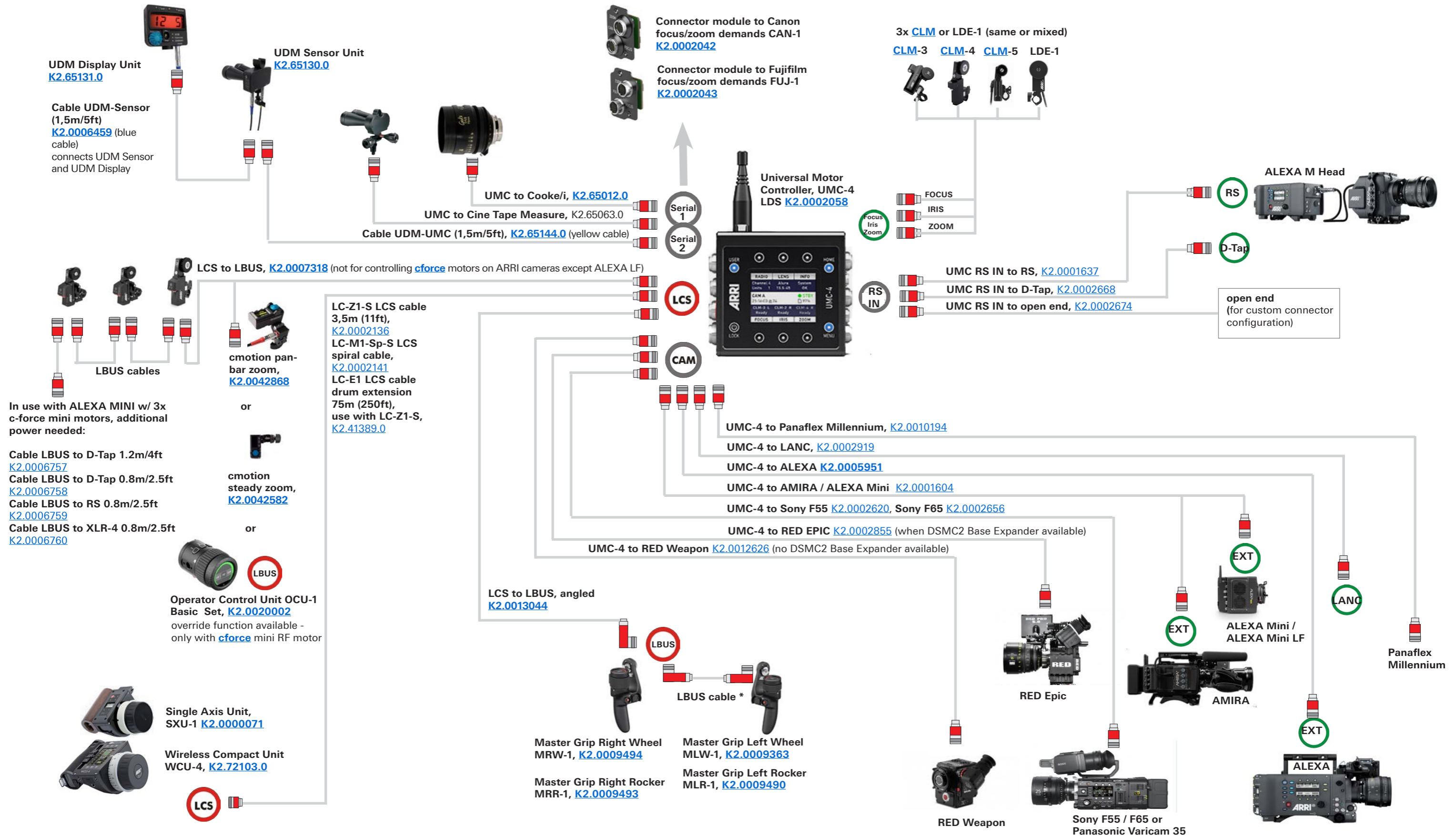

## Lens Control System



**ERM-2400 Ext 2.4 GHz RXD-TXD Pro Set LCS, [KK.0040048](#)**  
[K2.0037440](#) 2x ERM-2400,LCS, Single Module  
[K2.0033763](#) 2x ERM-2400 Rubber Duck Antenna  
[K2.0036900](#) 2x ERM LCS to FS CAN Bus Adapter Cable, 0.2m/0.65ft  
[K2.0036903](#) 2x ERM LBUS to FS CAN Bus Adapter Cable, 0.2m/0.65ft  
[K2.0036901](#) 1x ERM EXT. to FS CAN Bus Adapter Cable, 0.2m/0.65ft  
[K2.0036902](#) 1x ERM D-Tap Pwr Cable, 0B Lemo 2pin to D-Tap, 1m/3.2ft  
[K2.0033762](#) 2x SRH FS CAN Bus Cable, 1m/3.2ft

Note:  
The basic set is only supplied with adapter cables.

Recommended and required optional extension cables:  
 • SRH FS CAN Bus Cable, 10m/32.8ft [K2.0019302](#)  
 • SRH FS CAN Bus Cable, 25m/82ft [K2.0019301](#)  
 • SRH FS CAN Bus Coupler, 0.2m/0.65ft [K2.0019300](#)



**ERM-2400, LCS, Single Spare Module**  
[K2.0037440](#), incl. Antenna  
 coupling through ARRI Service

## Stabilized Remote Head



**ERM-2400 2.4 GHz RXD-TXD Basic Set, SRH-3, [KK.0040049](#)**  
 includes:  
[K2.0037428](#) 2x ERM-2400, SRH, Single Module  
[K2.0033763](#) 2x ERM-2400 Rubber Duck Antenna  
[K2.0033762](#) 2x SRH FS CAN Bus Cable, 1m/3.2ft  
[K2.0033761](#) 1x ERM Power Cable, ERM-2400 & ERM-900

Range:  
Up to 1000 meter / 3280 ft.



**ERM-2400, SRH, Single Spare Module**  
[K2.0037428](#), incl. Antenna



**ERM-900 MHz RXD-TXD Basic Set, SRH-3, [KK.0040050](#)**  
 includes:  
[K2.0037425](#) 2x ERM-900, SRH, Single Module  
[K2.0033765](#) 2x ERM-900 Rubber Duck Antenna  
[K2.0033762](#) 2x SRH FS CAN Bus Cable, 1m/3.2ft  
[K2.0033761](#) 1x ERM Power Cable, ERM-2400 & ERM-900

Range:  
Up to 3000 meter / 6560 ft



**ERM-900, SRH, Single Spare Module**  
[K2.0037425](#), incl. Antenna

## Cables



**ERM LCS to FS CAN Bus Adapter Cable 0.2m/0.65ft**  
[K2.0036900](#)



**ERM LBUS to FS CAN Bus Adapter Cable, 0.2m/0.65ft**  
[K2.0036903](#)



**ERM EXT. to FS CAN Bus Adapter Cable, 0.2m/0.65ft**  
[K2.0036901](#)



**ERM D-Tap Pwr Cable, 0B Lemo 2pin to D-Tap, 1m/3.2ft,**  
[K2.0036902](#)



Required optional extension cables:  
 SRH FS CAN Bus Cable, 0,3m/0.98ft, [K2.0037788](#)  
 SRH FS CAN Bus Cable, 1m/3.2ft, [K2.0033762](#)  
 SRH FS CAN Bus Cable, 5m/16.4ft, [K2.0037701](#)  
 SRH FS CAN Bus Cable, 10m/32.8ft, [K2.0019302](#)  
 SRH FS CAN Bus Cable, 25m/82ft, [K2.0019301](#)

## LCS Configuration Samples

For Configuration Sample with the Lens Control System please also see **Configuration Overview 4.8.1 & 4.8.2**

## SRH Configuration Samples

For Configuration Sample with the SRH-360 & SRH-3 System please also see **Configuration Overview 8.4.2 & 8.4.3 & 8.5.1**



**ERM-2400 Rubber Duck Antenna, [K2.0033763](#)**



**ERM-900 Rubber Duck Antenna, [K2.0033765](#)**

# ERM - External Radio Module - Sample Configurations, Part I



Configuration Overview | 4.7.1 / 2025.10

## ALEXA Mini / ALEXA Mini LF with 3 motors

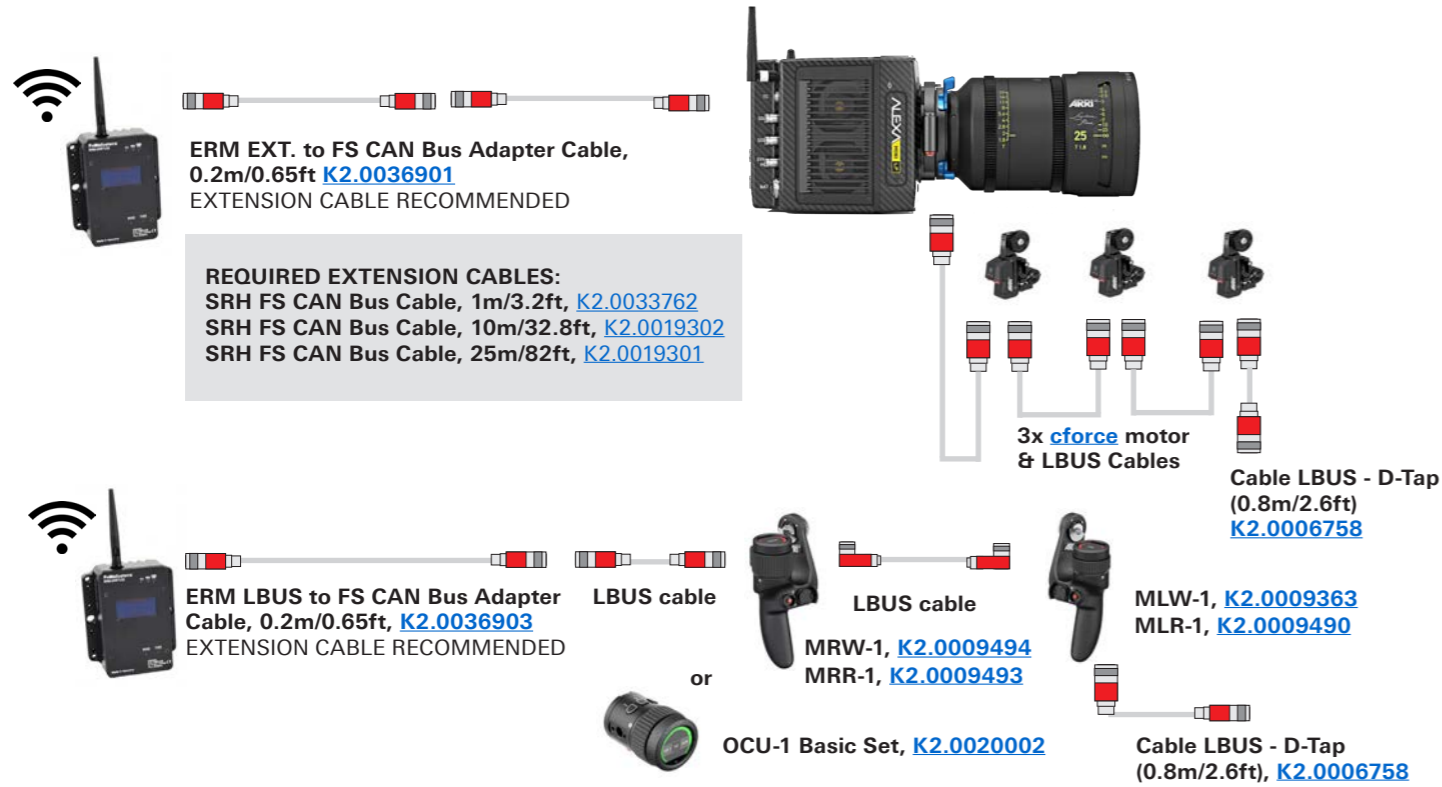

## ALEXA Mini / ALEXA Mini LF with 2 motors

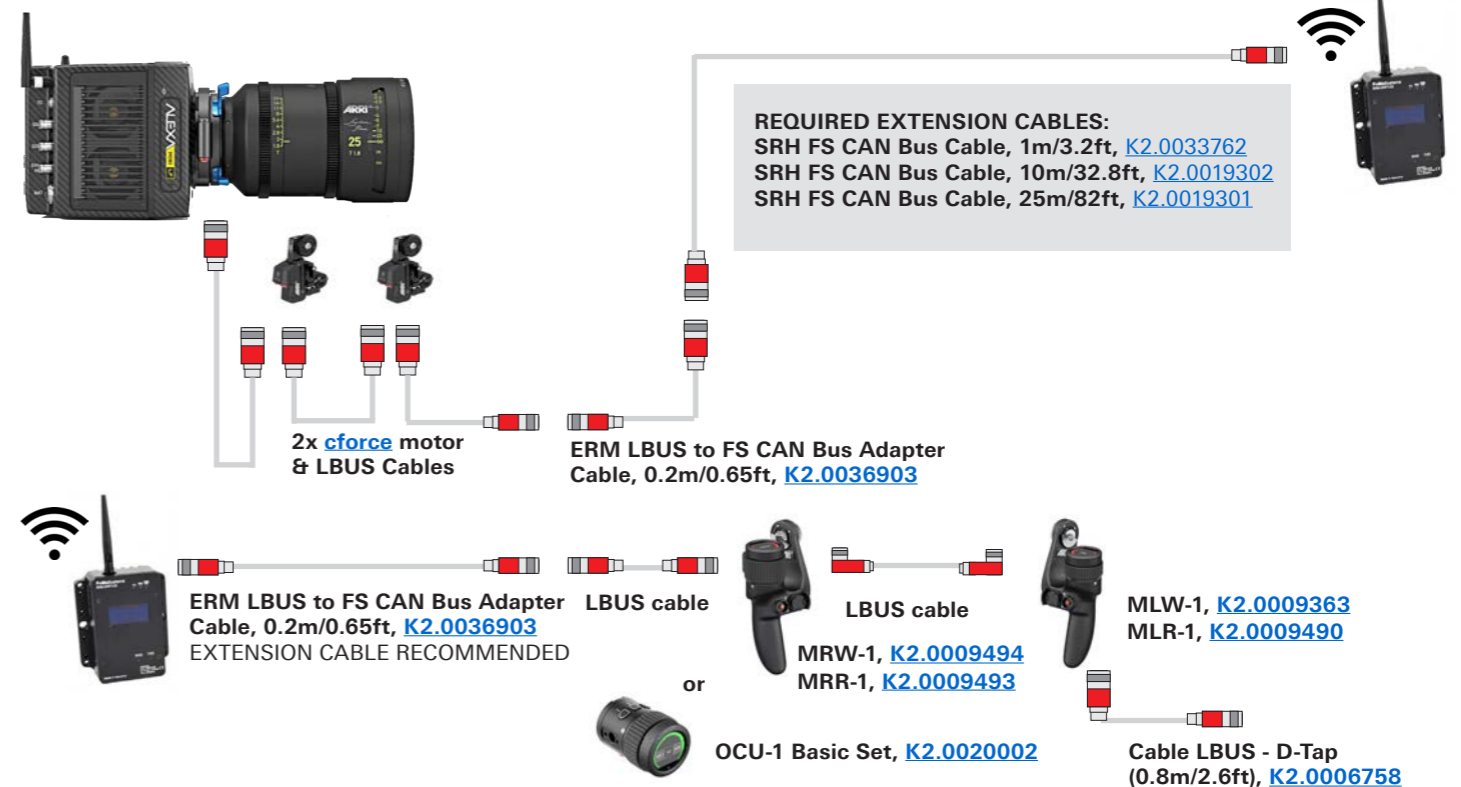

## Amira with 3 motors - **cforce** mini RF and/or **cforce** mini/plus



## Amira with 3 **cforce** mini motors



# ERM - External Radio Module - Sample Configurations, Part II



Configuration Overview | 4.7.2 / 2025.10

## ALEXA Plus / ALEXA LF with CLM motors

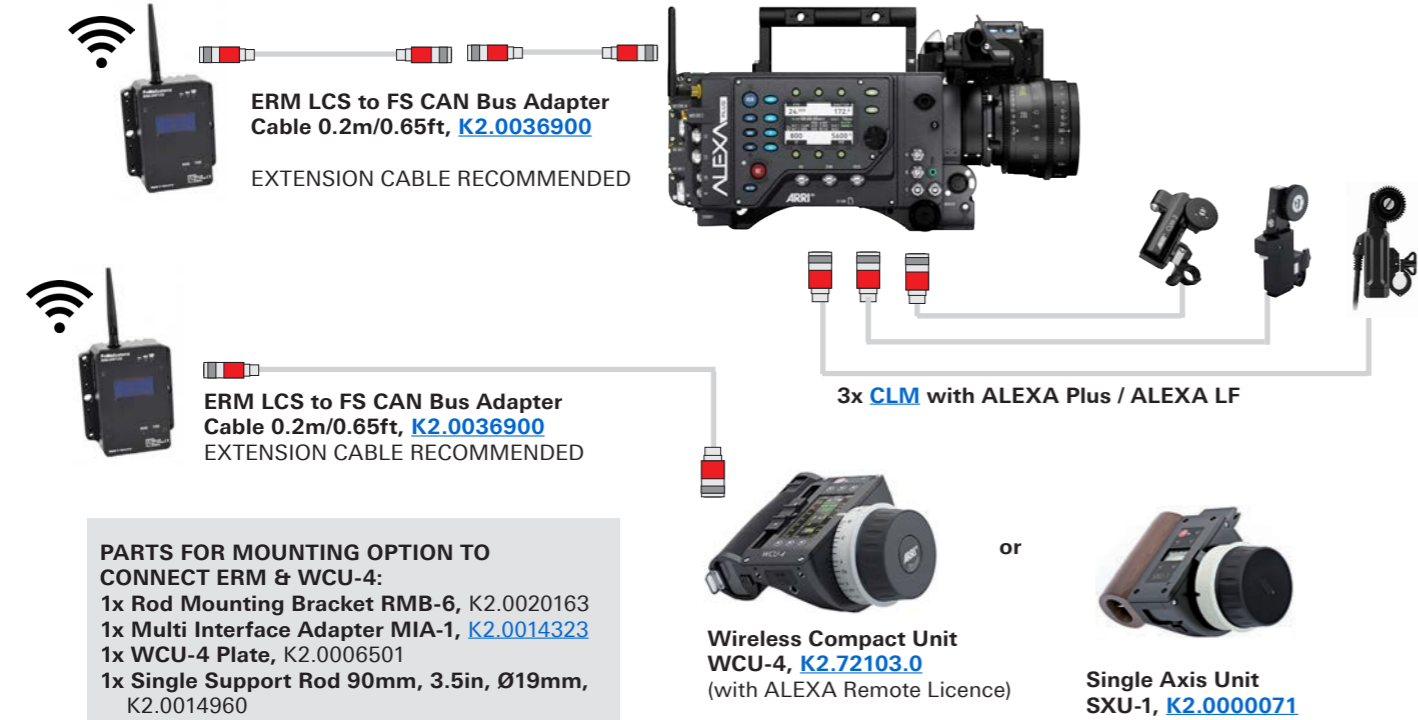

## ALEXA Plus / ALEXA LF with c-force motors

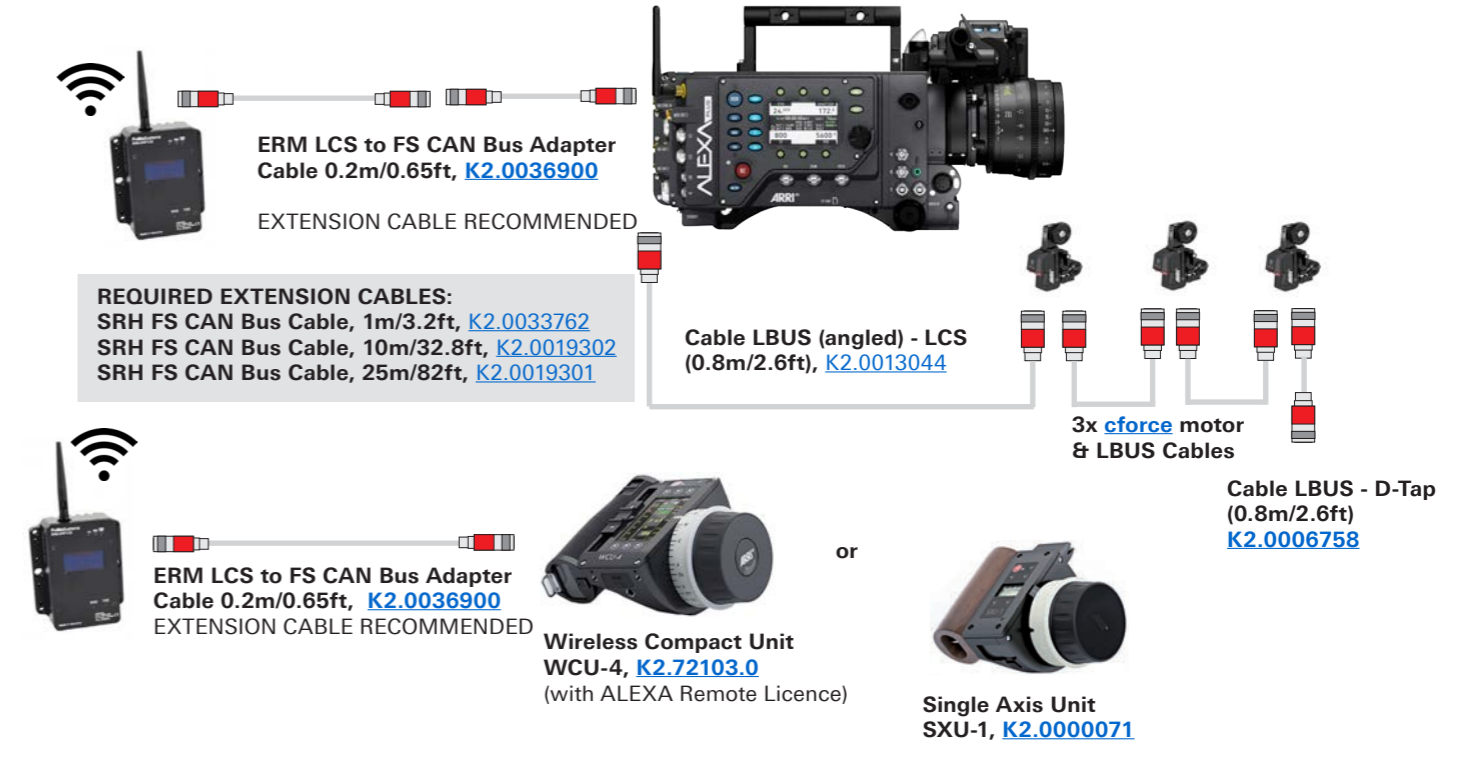

## ALEXA Plus / ALEXA LF - two radio connections



## 3rd Party Camera

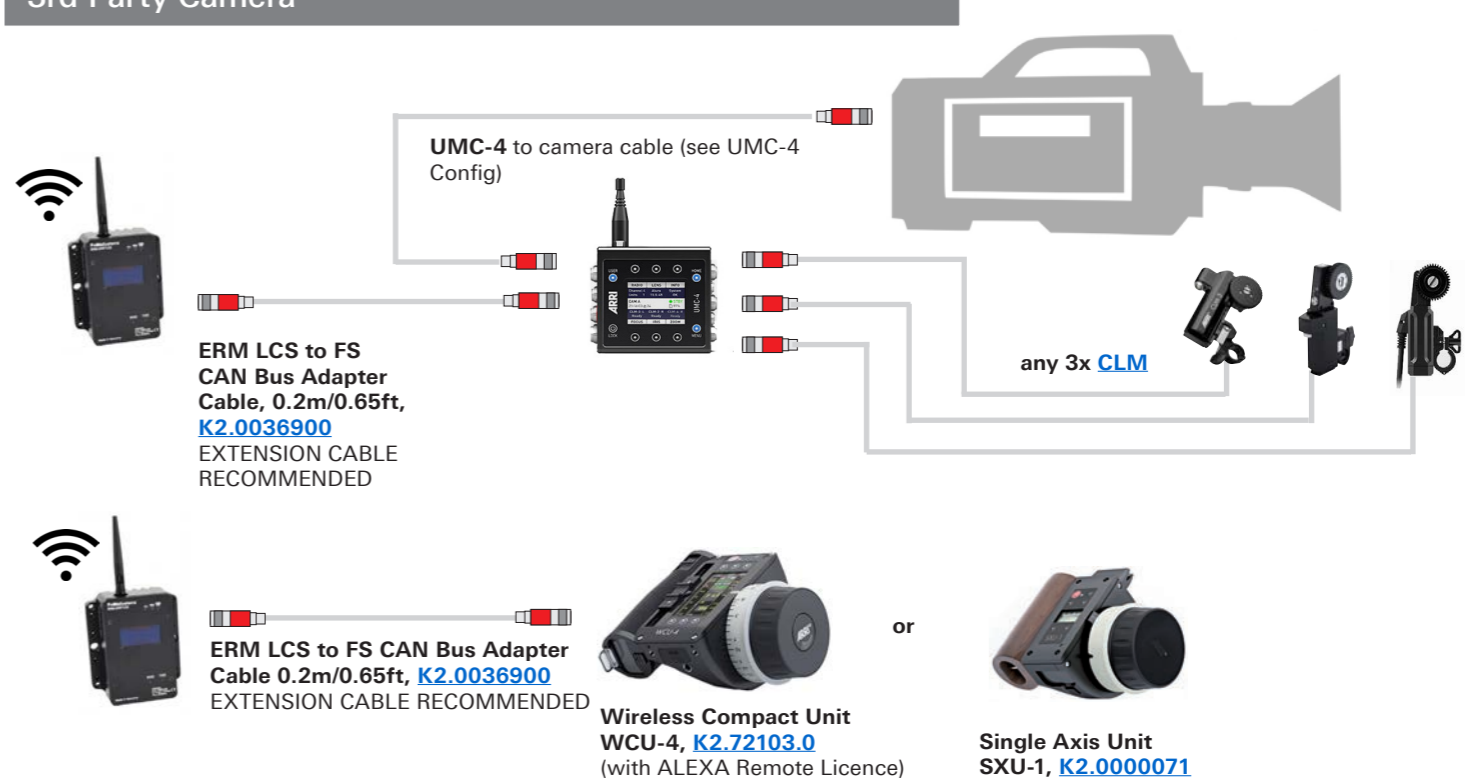

# Ultrasonic Distance Measure UDM-1



Configuration Overview | 4.8.0 / 2025.10

## UDM-1 Distance Measure

### Ultrasonic Distance Measure UDM-1 Set

[KK.0005853](#)

Set includes:

UDM Sensor Unit, [K2.65130.0](#)

UDM Display Unit, [K2.65131.0](#)

Cable UDM-Sensor, [K2.0006459](#)



UDM Display Unit  
[K2.65131.0](#)

UDM Sensor Unit  
[K2.65130.0](#)

Cable UDM-Sensor (1,5m/5ft)  
[K2.0006459](#) (blue cable)  
connects UDM Sensor and UDM Display

Cable UDM-PSC (1,5m/5ft)  
[K2.65262.0](#) (yellow cable)  
Additional PSC power cable  
needed

## PSC Power Cable



### PSC Cable System:

Both needed:  
PSC cable to device  
PSC power cable to power source

### ARRI PSC power supply cables

K2.65206.0 PSC-XLR3	1,5m/5ft	1,5m/5ft	24 Volts battery
K2.65207.0 PSC-XLR4	1,5m/5ft	1,5m/5ft	12 Volts battery
K2.65211.0 PSC-RS	0,6m/2ft	0,6m/2ft	ARRI RS socket
K2.65212.0 PSC-FI2	0,6m/2ft	1,5m/5ft	ARRI OBB-2 battery

Cable UDM-UMC (1,5m/5ft)  
[K2.65144.0](#) (yellow cable)

Connects to CUB-1



LCUBE CUB-1 Basic Set  
[KK.0009001](#)



LBUS 0.2m/8", [K2.0006749](#)  
LBUS 0.3m/1ft, [K2.0006750](#)  
LBUS 0.5m/1.5ft, [K2.0006751](#)  
LBUS 0.8m/2.5ft, [K2.0006752](#)  
LBUS 1.5m/5ft, [K2.0006753](#)  
LBUS 3m/10ft, [K2.0006754](#)  
LBUS 6m/20ft, [K2.0006755](#)  
LBUS 15m/49ft, [K2.0006756](#)



cforce motors



ALEXA Mini /  
ALEXA Mini LF

Cable UDM - EXT (16p)  
(0.5m/1.6ft) [K2.65261.0](#) (yellow cable)  
Connects to EXT socket of ALEXA  
cameras with SUP 8.0 or later



ALEXA

UDM values / Lens Data

Focus Tracking

WCU-4



Wireless Compact Unit  
WCU-4, [K2.72103.0](#)

UDM values / Lens Data

Focus Tracking

Hi-5



Hi-5 Hand Unit Body  
Set, [KK.0039973](#)  
Radio Module needed

Cable UDM - SERIAL (7p) (1.5m/5ft),  
[K2.65144.0](#) (yellow cable)



Connects to UMC-4



Cable UDM - SERIAL (4p) (0.8m/2.6ft)  
[K2.0041172](#)



Connects to RIA-1



Cable UDM-RS (1,5m/5ft)  
[K2.65240.0](#) (yellow cable)  
Connects to camera RS socket



any camera  
with RS



AMIRA

Cable CAM (10p) - RS (3p) (0.5m/1.6ft), [K2.0001606](#)



AMC-1

Cable UDM-D.Tap (0,8m/2,6ft)  
[K2.0023553](#)



Cable UDM-UMC (1,5m/5ft)  
[K2.65144.0](#) (yellow cable)



Connects to CUB-1



LCUBE CUB-1 Basic Set  
[KK.0009001](#)



LBUS 0.2m/8", [K2.0006749](#)  
LBUS 0.3m/1ft, [K2.0006750](#)  
LBUS 0.5m/1.5ft, [K2.0006751](#)  
LBUS 0.8m/2.5ft, [K2.0006752](#)  
LBUS 1.5m/5ft, [K2.0006753](#)  
LBUS 3m/10ft, [K2.0006754](#)  
LBUS 6m/20ft, [K2.0006755](#)  
LBUS 15m/49ft, [K2.0006756](#)

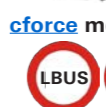

cforce motors

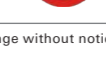

cmotion cdistance



cmotion cfinder III



cmotion cdistance  
K2.0015667



LBUS Cable

- LBUS 0.2m/8", [K2.0006749](#)
- LBUS 0.3m/1ft, [K2.0006750](#)
- LBUS 0.5m/1.5ft, [K2.0006751](#)
- LBUS 0.8m/2.5ft, [K2.0006752](#)
- LBUS 1.5m/5ft, [K2.0006753](#)
- LBUS 3m/10ft, [K2.0006754](#)
- LBUS 6m/20ft, [K2.0006755](#)
- LBUS 15m/49ft, [K2.0006756](#)

- LBUS 0.2m/8", [K2.0006749](#)
- LBUS 0.3m/1ft, [K2.0006750](#)
- LBUS 0.5m/1.5ft, [K2.0006751](#)
- LBUS 0.8m/2.5ft, [K2.0006752](#)
- LBUS 1.5m/5ft, [K2.0006753](#)
- LBUS 3m/10ft, [K2.0006754](#)
- LBUS 6m/20ft, [K2.0006755](#)
- LBUS 15m/49ft, [K2.0006756](#)

**Cable UDM-ALEXA (1,5m/5ft)**  
[K2.65261.0](#) (yellow cable)  
Connects to EXT socket of ALEXA cameras with SUP 8.0 or later

**Cable UDM-SERIAL (1,5m/5ft)**  
[K2.65144.0](#) (yellow cable)

**Cable LBUS - RS (0.8m/2.6ft)**  
[K2.0006759](#)

- LBUS 0.2m/8", [K2.0006749](#)
- LBUS 0.3m/1ft, [K2.0006750](#)
- LBUS 0.5m/1.5ft, [K2.0006751](#)
- LBUS 0.8m/2.5ft, [K2.0006752](#)
- LBUS 1.5m/5ft, [K2.0006753](#)
- LBUS 3m/10ft, [K2.0006754](#)
- LBUS 6m/20ft, [K2.0006755](#)
- LBUS 15m/49ft, [K2.0006756](#)

additional power might be needed:

- Cable LBUS to D-Tap 1.2m/4ft  
[K2.0006757](#)
- Cable LBUS to D-Tap 0.8m/2.5ft  
[K2.0006758](#)
- Cable LBUS to RS 0.8m/2.5ft  
[K2.0006759](#)
- Cable LBUS to XLR-4 0.8m/2.5ft  
[K2.0006760](#)



cforce motor



ALEXA



UMC-4



AMIRA

SMC/EMC/AMC to RS, [K2.0001606](#)



WCU-4

Wireless Compact Unit  
WCU-4, [K2.72103.0](#)



ALEXA Mini /  
ALEXA Mini LF



cdistance readout



AMC-1

Focus Tracking

UDM values / Lens Data

Focus Tracking

UDM values / Lens Data

Focus Tracking

UDM values /  
no Lens Data

# Network Interface Adapter NIA-1 - Configuration Overview



Configuration Overview | 4.9.0 / 2025.10

## NIA-1 Sample Configuration

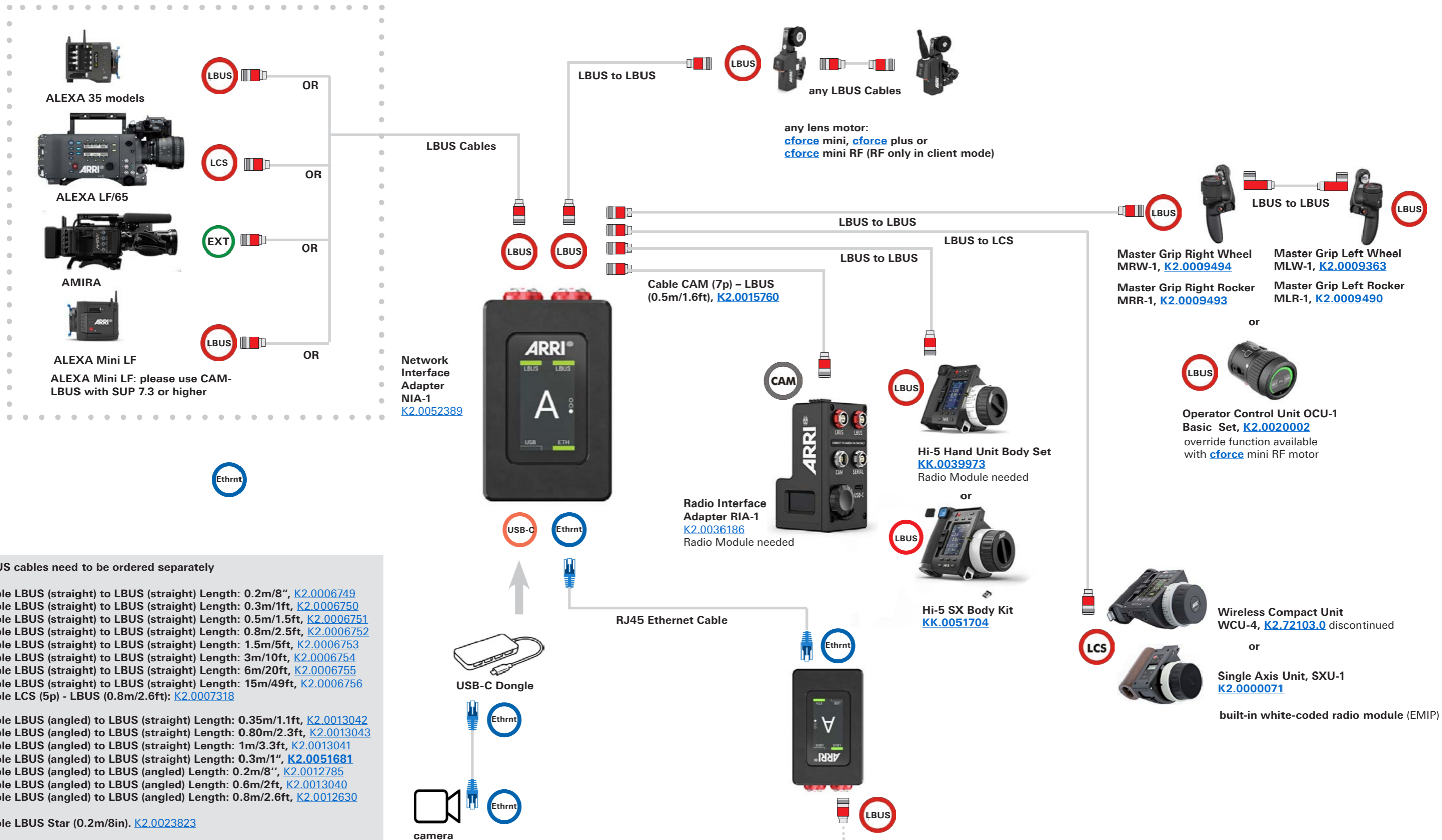

# Network Interface Adapter NIA-1 - Sample Configurations 1



Configuration Overview | 4.9.1 / 2025.10

## ALEXA 35 models & NIA-1

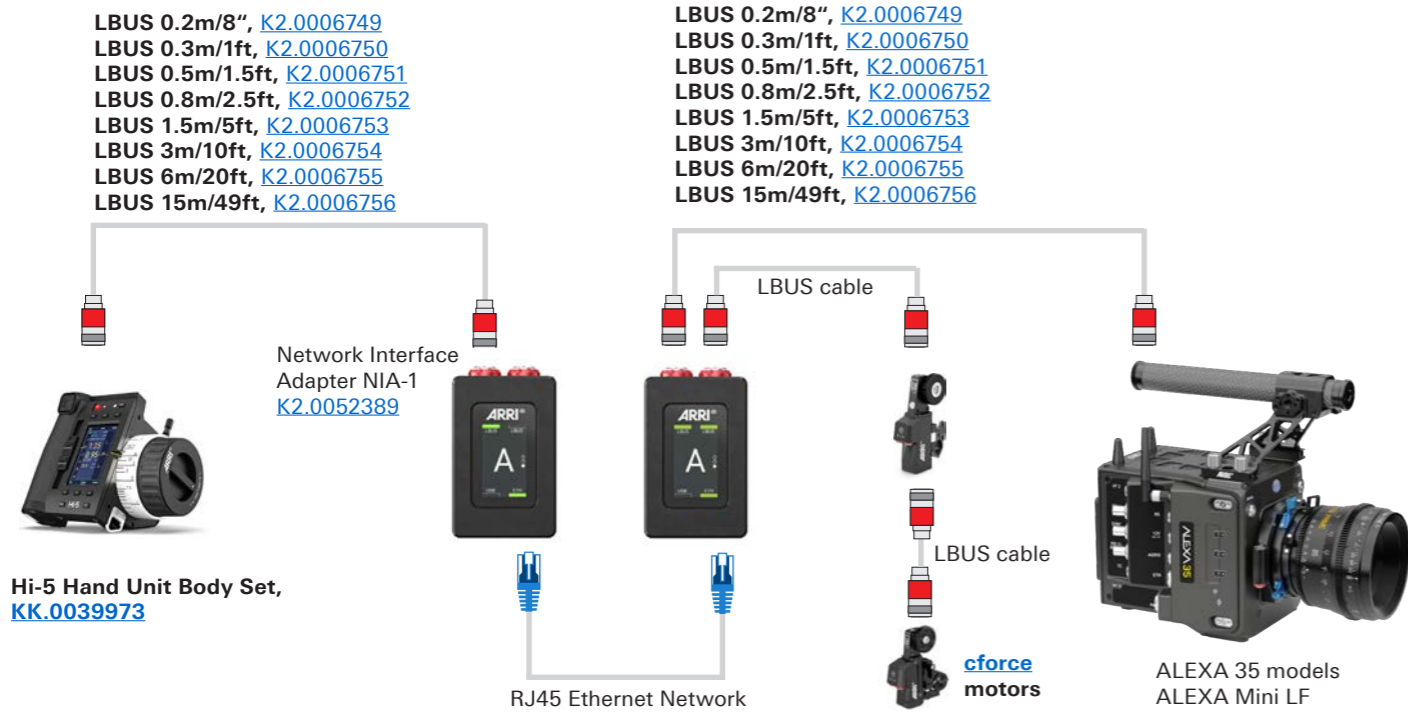

## ALEXA 35 models & NIA-1 & 2x Hi-5 & RIA-1

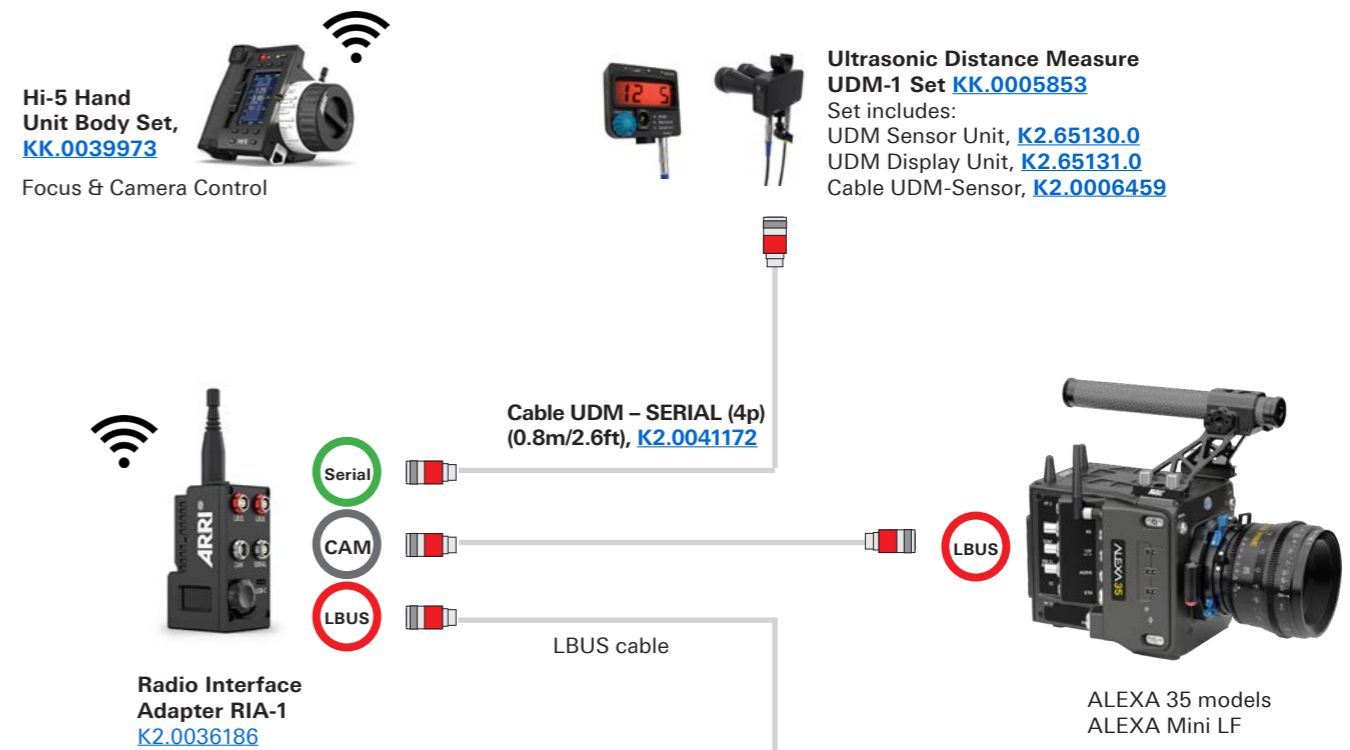

## ALEXA 35 models & NIA-1 & 2x Hi-5

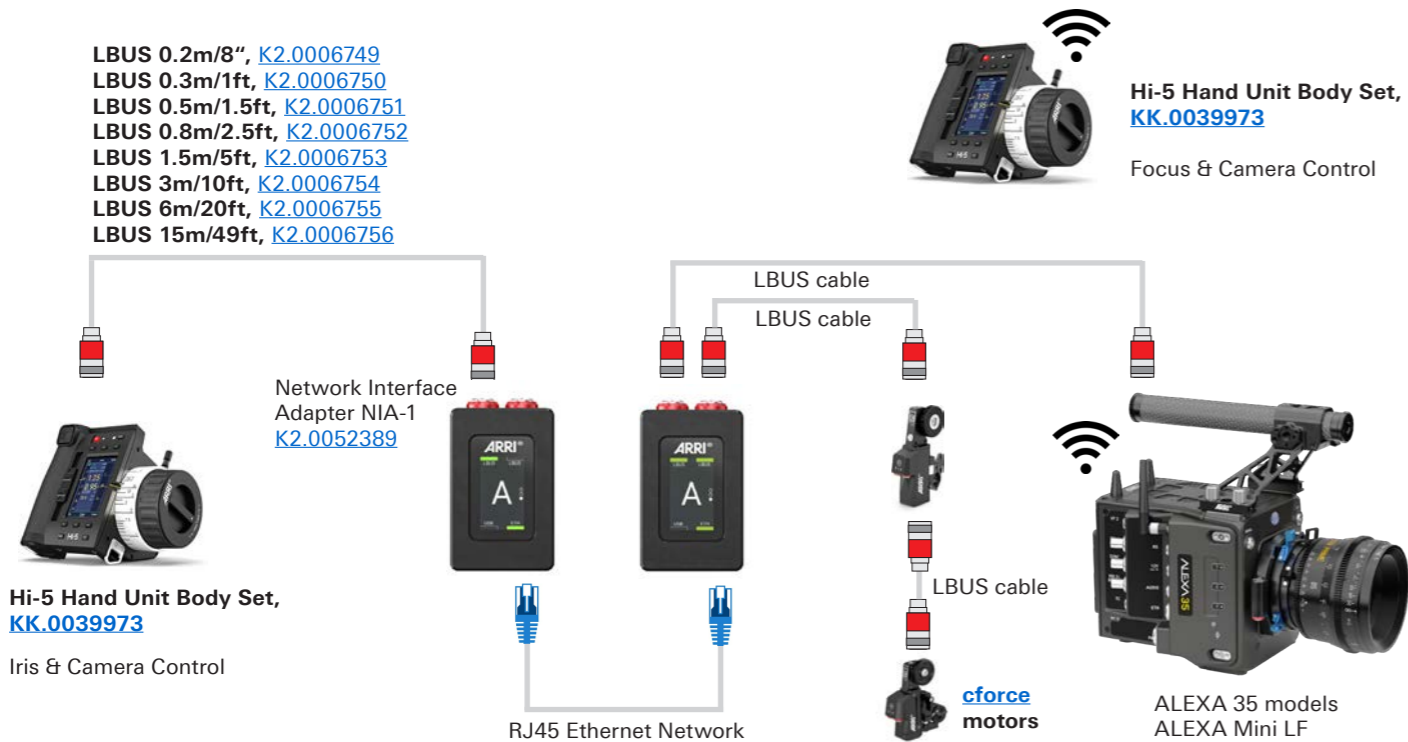

# Network Interface Adapter NIA-1 - Sample Configurations 2



Configuration Overview | 4.9.2 / 2025.10

## ALEXA 35 models & NIA-1 & Hi-5 & RIA-1

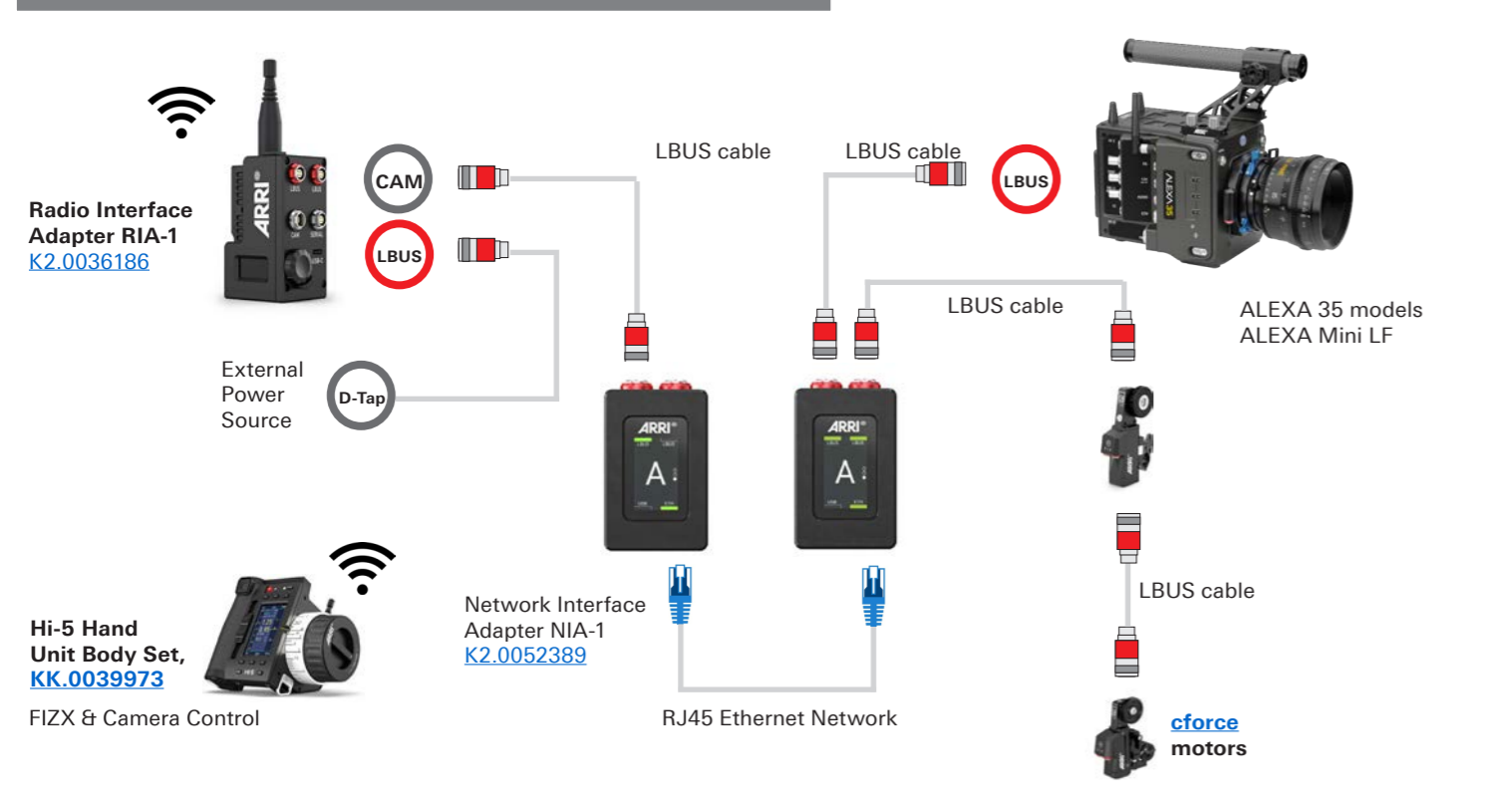

## Sony Burano & NIA-1



## 3rd Party Control via **cforce** mini RF

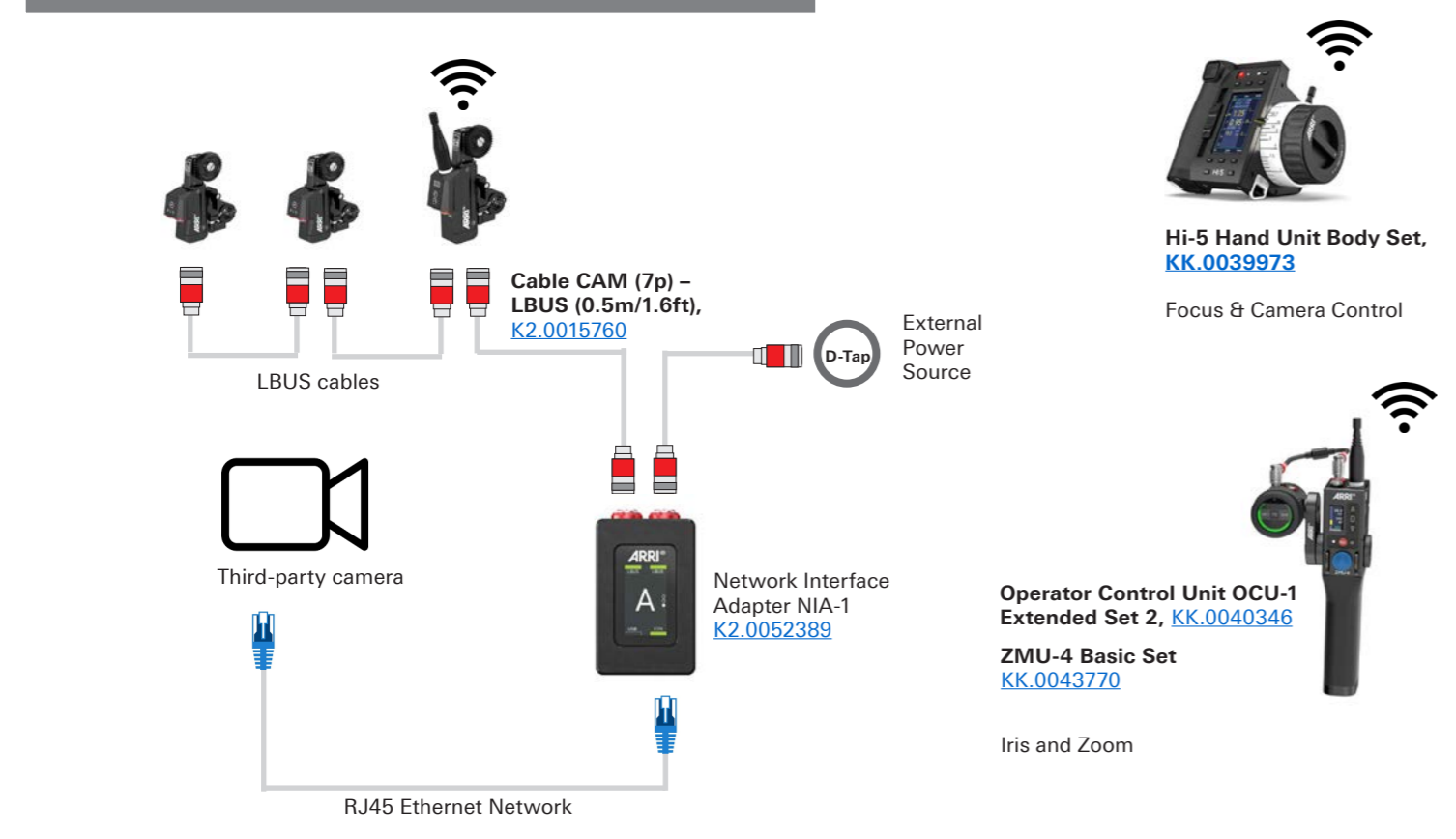

## Blackmagic URSA Cine & NIA-1

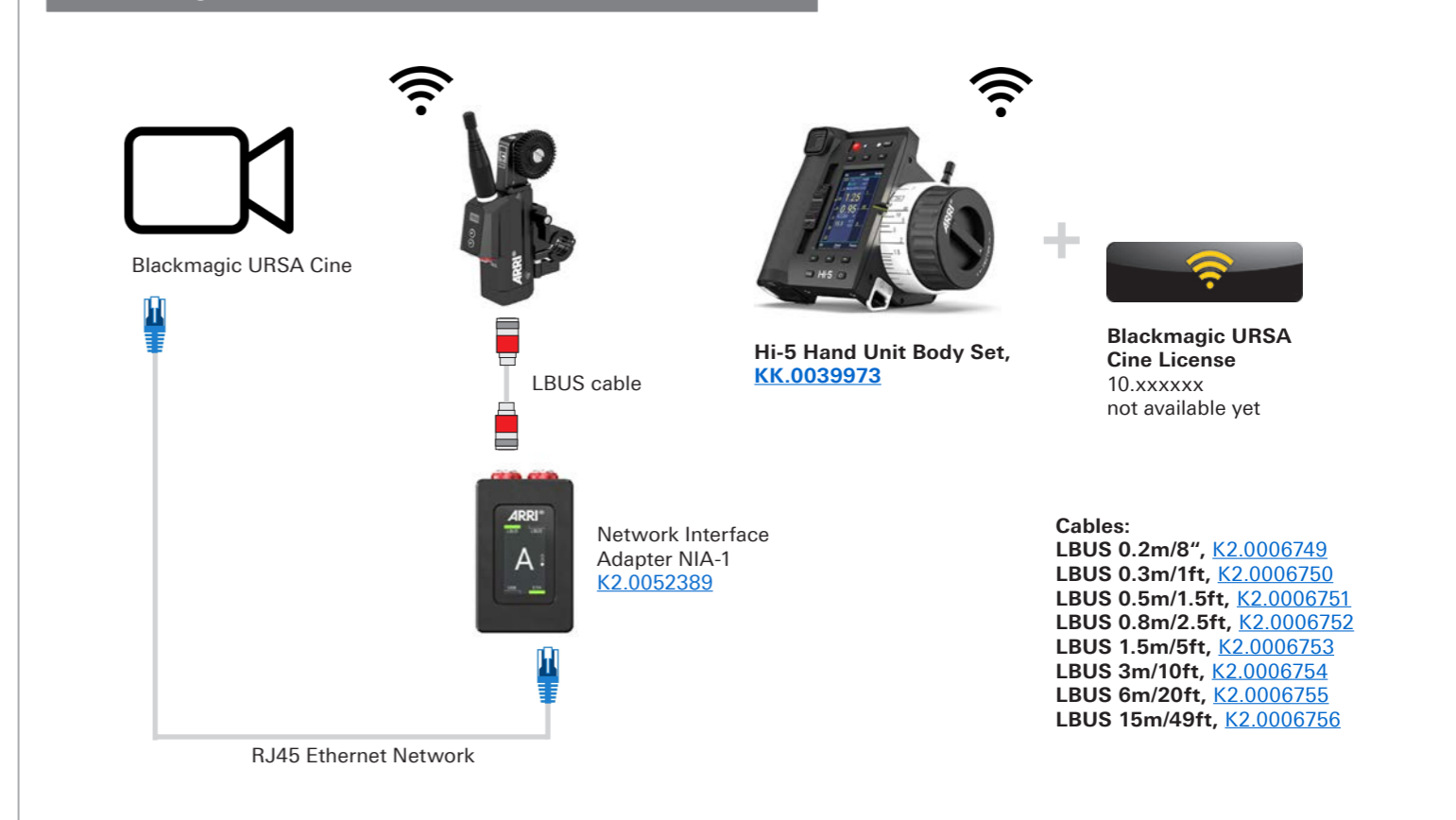

# Network Interface Adapter NIA-1 - Sample Configurations 3



Configuration Overview | 4.9.3 / 2026.05

## 3rd Party Camera Control via RIA-1

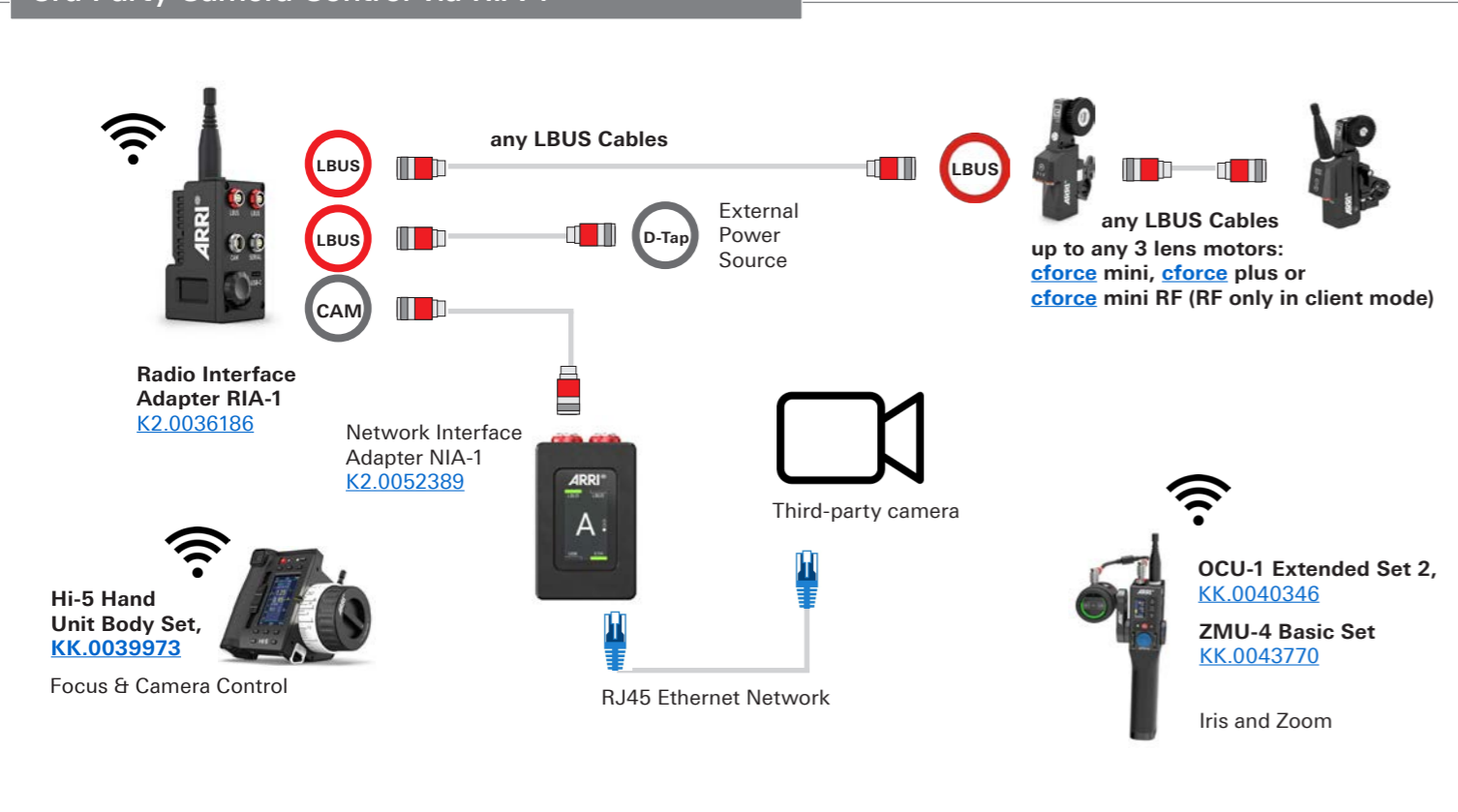

## Further “NIA-1 Configuration Overviews” will follow.

- Cable CAM (7p) – LBUS (0.3m/1ft), (0.3m/1ft), [K2.0025027](#)
- Cable CAM (7p) – LBUS (0.5m/1.6ft), [K2.0015760](#)
- Cable CAM (7p) – EXT (6p) (0.6m/2ft), [K2.015756](#)
- Cable CAM (7p) – EXT (16p) (0.8m/2.6ft), [K2.0015755](#)
- Cable CAM (7p) – LCS (5p), [K2.0034580](#)
- Cable CAM (7p) – RED CTRL/D-Tap (0.6m/2ft), [K2.0015758](#)
- Cable CAM (7p) – LANC/D-Tap (0.6m/2ft), [K2.0015757](#)
- Cable CAM (7p) – Sony F55 CTRL/D-Tap (0.6m/2ft), [K2.0018814](#)
- Cable CAM (7p) – Sony Remote (8p)/D-Tap (0.8m/2.6ft), (0.3m/1ft), [K2.0047268](#)
- Cable CAM (7p) – RS (0.3m/1ft), [K2.0015754](#)
- Cable CAM (7p) – D-Tap (0.5m/1.6ft), [K2.0018813](#)
- Cable CAM (7p, f) – CAM (7p, m), (0.3m/1ft), [K2.0023832](#)
- Cable CAM (7p) – ENG (12p) (0.3m/1ft), [K2.0015759](#)

## NIA-1 Lens & Recording Synchronization

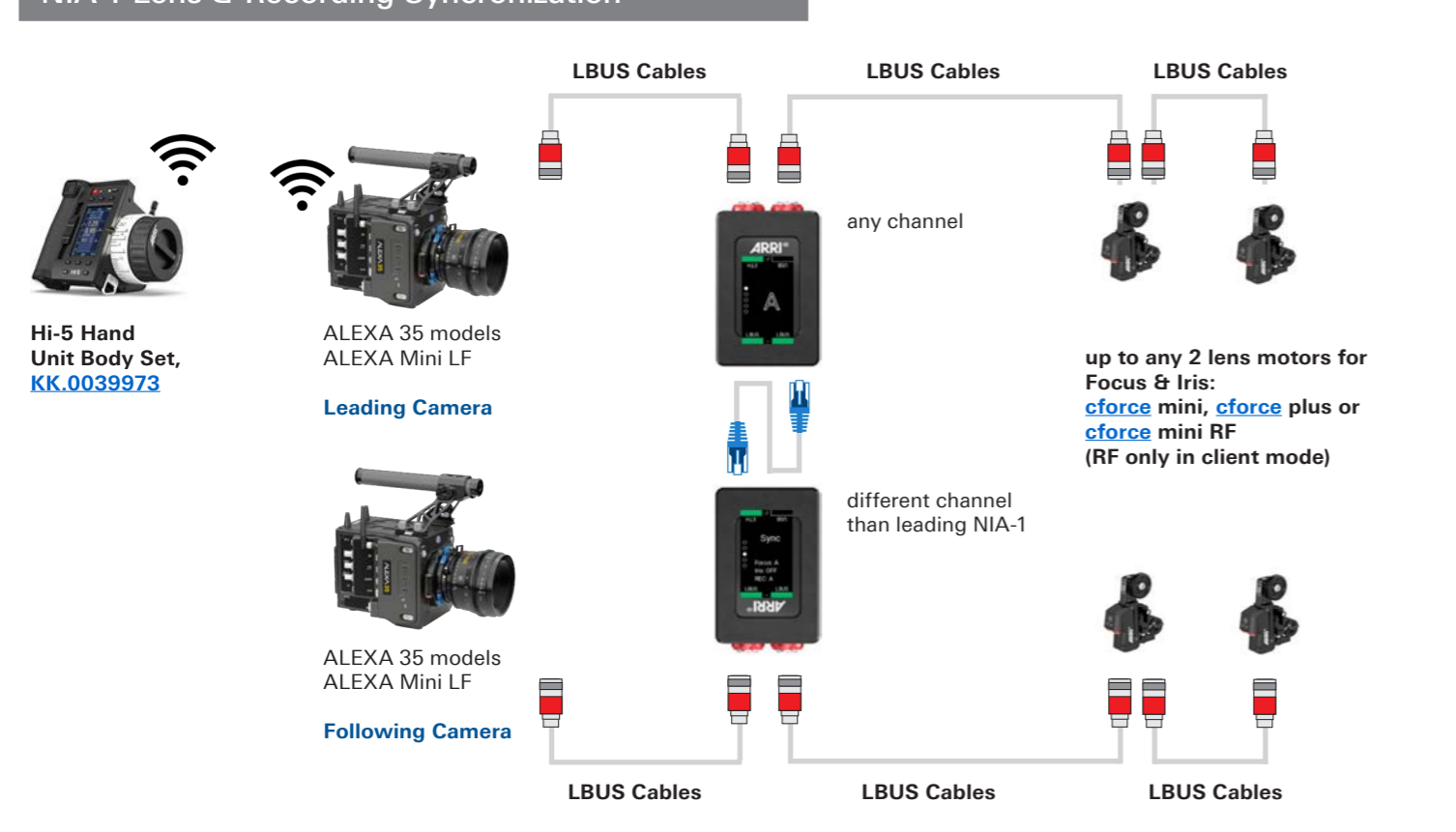

### LBUS cables need to be ordered separately

- Cable LBUS (straight) to LBUS (straight) Length: 0.2m/8", [K2.0006749](#)
- Cable LBUS (straight) to LBUS (straight) Length: 0.3m/1ft, [K2.0006750](#)
- Cable LBUS (straight) to LBUS (straight) Length: 0.5m/1.5ft, [K2.0006751](#)
- Cable LBUS (straight) to LBUS (straight) Length: 0.8m/2.5ft, [K2.0006752](#)
- Cable LBUS (straight) to LBUS (straight) Length: 1.5m/5ft, [K2.0006753](#)
- Cable LBUS (straight) to LBUS (straight) Length: 3m/10ft, [K2.0006754](#)
- Cable LBUS (straight) to LBUS (straight) Length: 6m/20ft, [K2.0006755](#)
- Cable LBUS (straight) to LBUS (straight) Length: 15m/49ft, [K2.0006756](#)
- Cable LCS (5p) - LBUS (0.8m/2.6ft): [K2.0007318](#)

- Cable LBUS (angled) to LBUS (straight) Length: 0.35m/1.1ft, [K2.0013042](#)
- Cable LBUS (angled) to LBUS (straight) Length: 0.80m/2.3ft, [K2.0013043](#)
- Cable LBUS (angled) to LBUS (straight) Length: 1m/3.3ft, [K2.0013041](#)
- Cable LBUS (angled) to LBUS (straight) Length: 0.3m/1", [K2.0051681](#)
- Cable LBUS (angled) to LBUS (angled) Length: 0.2m/8", [K2.0012785](#)
- Cable LBUS (angled) to LBUS (angled) Length: 0.6m/2ft, [K2.0013040](#)
- Cable LBUS (angled) to LBUS (angled) Length: 0.8m/2.6ft, [K2.0012630](#)

- Cable LBUS Star (0.2m/8in). [K2.0023823](#)

## Configuration Overview | 5.1.0 / 2024.11

### Set for Panasonic AU-EVA1

#### Basic Set for Panasonic AU-EVA1

Consists of:  
 Plate for Panasonic AU-EVA1 [K2.0015883](#)  
 Top Plate for Panasonic AU-EVA1 [K2.0015880](#)  
 Support Rods 240 mm (9.4 inch), Ø 15 mm [K2.66253.0](#)

[KK.0016260](#)



Plate for Panasonic AU-EVA1  
[K2.0015883](#)



Top Plate for Panasonic AU-EVA1 [K2.0015880](#)

#### Pro Set for Panasonic AU-EVA1

Consists of:  
 Plate for Panasonic AU-EVA1 [K2.0015883](#)  
 Top Plate for Panasonic AU-EVA1 [K2.0015880](#)  
 Support Rods 240 mm (9.4 inch), Ø 15 mm [K2.66253.0](#)  
 Monitor Bracket for Panasonic AU-EVA1 [K2.0016259](#)  
 HGA-3 for Panasonic AU-EVA1 [K2.0016711](#)  
 Battery Adapter Plate BAP-1 [K2.0006471](#)  
 15 mm LWS Rod Console [K2.65264.0](#)  
 Support Rods 140 mm (5.5 inch), Ø 15 mm (2x) [K2.66254.0](#)

[KK.0016261](#)



Monitor Bracket for Panasonic AU-EVA1, [K2.0016259](#) \*



HGA-3 for Panasonic AU-EVA1 [K2.0016711](#)

### Sets for RED DSMC2

#### Basic Cine Set for RED DSMC2

Consists of:  
 Cine plate for RED DSMC2 [K2.0008886](#)  
 Support Rods 240 mm (9.4 inch), Ø 15 mm [K2.66253.0](#)  
 Support Rods 140 mm (5.5 inch), Ø 15 mm [K2.66254.0](#)  
 Bridge Plate Sled, BPS-2 [K2.66260.0](#)  
 Bottom Dovetail Plate 300mm/12in [K2.0015896](#)  
 Top plate for RED DSMC2 [K2.0009664](#)  
 Top handle for RED DSMC2 [K2.0008903](#)  
 Monitor bracket for RED DSMC2 [K2.0009582](#)

[KK.0010059](#)



Cine Plate for RED DSMC2,  
K2.0008886



Top Plate for RED DSMC2,  
[K2.0009664](#)

#### Pro Cine Set 19 mm for RED DSMC2

Consists of:  
 Cine plate for RED DSMC2 [K2.0008886](#)  
 Support Rods 240 mm (9.4 inch), Ø 15 mm [K2.66253.0](#)  
 Support Rods 140 mm (5.5 inch), Ø 15 mm [K2.66254.0](#)  
 Top plate for RED DSMC2 [K2.0009664](#)  
 Top handle for RED DSMC2 [K2.0008903](#)  
 Monitor bracket for RED DSMC2 [K2.0009582](#)  
 Bridge Plate BP-8 Set (19 mm Rods) [K2.47090.0](#)

[KK.0010066](#)



Broadcast Plate for RED DSMC2,  
[K2.0009614](#)



Top Handle for RED DSMC2,  
[K2.0008903](#)

#### Pro Cine Set 15 mm for RED DSMC2

Consists of:  
 Cine plate for RED DSMC2 [K2.0008886](#)  
 Support Rods 240 mm (9.4 inch), Ø 15 mm [K2.66253.0](#)  
 Support Rods 140 mm (5.5 inch), Ø 15 mm [K2.66254.0](#)  
 Top plate for RED DSMC2 [K2.0009664](#)  
 Top handle for RED DSMC2 [K2.0008903](#)  
 Monitor bracket for RED DSMC2 [K2.0009582](#)  
 Bridge Plate BP-9 Set (15 mm Rods) [K2.47091.0](#)

[KK.0010068](#)



Monitor Bracket for RED DSMC2,  
[K2.0009582](#)



Viewfinder Bracket for RED DSMC2, [K2.0012522](#)

#### Broadcast Set for RED DSMC2

Consists of:  
 Broadcast plate for RED DSMC2 [K2.0009614](#)  
 Support Rods 240 mm (9.4 inch), Ø 15 mm [K2.66253.0](#)  
 Quick Release Plate, QRP-1 [K2.0000399](#)  
 Top plate for RED DSMC2 [K2.0009664](#)  
 Top handle for RED DSMC2 [K2.0008903](#)  
 Monitor bracket for RED DSMC2 [K2.0009582](#)

[KK.0010069](#)

### Brackets for Electronic Viewfinders

#### Viewfinder Cross Pipe RMB-3 Set

Consists of:  
 Viewfinder Cross Pipe [K2.0013302](#)  
 Rod Mounting Bracket RMB-3 [K2.0006186](#)

[KK.0013311](#)



Monitor Bracket for Canon LM-V1/2, [K2.0015520](#) \*



Monitor Bracket for Panasonic AU-EVA1,  
[K2.0016259](#) \*

#### EVF bracket set for Sony DVF-EL200

Consists of:  
 Mini Viewfinder Bracket MVB-1 [K2.0006140](#)  
 EVF bracket for Sony DVF-EL200 (Venice) [K2.0021525](#)

[KK.0022326](#)

#### EVF bracket set for Zacuto Gratical

Consists of:  
 Viewfinder mounting bracket for ALEXA Mini (MVB-1) [K2.0006140](#)  
 EVF bracket for Zacuto Gratical [K2.0008624](#)

[KK.0010048](#)



Viewfinder Bracket for VariCam, [K2.0010580](#)



EVF bracket for Zacuto Gratical, [K2.0008624](#)

#### EVF bracket set for Canon Monitor Unit

Consists of:  
 Viewfinder mounting bracket for ALEXA Mini (MVB-1) [K2.0006140](#)  
 EVF bracket for Canon Monitor Unit [K2.0008955](#)

[KK.0010060](#)



EVF bracket for Small HD Sidefinder, [K2.0008711](#)



Viewfinder Bracket for Canon EVF, [K2.0008955](#)

#### EVF bracket set for VariCam

Consists of:  
 Viewfinder mounting bracket for ALEXA Mini (MVB-1) [K2.0006140](#)  
 EVF bracket for VariCam [K2.0010580](#)

[KK.0012560](#)

#### EVF bracket set for RED Bomb Viewfinder

Consists of:  
 Viewfinder mounting bracket for ALEXA Mini (MVB-1) [K2.0006140](#)  
 EVF bracket for RED Bomb Viewfinder [K2.0008712](#)

[KK.0012695](#)



Viewfinder Bracket for RED Bomb, [K2.0008712](#)



EVF Bracket for Canon EVF-V70, [K2.0013195](#)

#### EVF bracket set for RED DSMC2

Consists of:  
 Viewfinder mounting bracket for ALEXA Mini (MVB-1) [K2.0006140](#)  
 EVF bracket for RED DSMC2 [K2.0012522](#)

[KK.0012693](#)



Viewfinder Bracket for RED DSMC2, [K2.0012522](#)



EVF bracket for Sony DVF-EL200 (Venice), [K2.0021525](#)



Viewfinder Cross Pipe  
[K2.0013302](#)

\* discontinued items  
 only as long as stock is available (single item)

## Configuration Overview | 5.1.1 / 2025.12

### Sholder Config with Clip-on Matt Box



#### Extended Pro Set for ETERNA 55, [K0.0055797](#)

- includes:
- [KK.0055440](#) 1x Basic Set for ETERNA 55
  - K2.0024161 1x Compact Shoulder Pad CSP-2
  - [K2.0054184](#) 2x NATO Rail Clamp NRC-6 (Rosette)
  - K2.0050467 1x Lightweight Support LWS-7
  - [K2.66253.0](#) 1x Support Rods 240mm/9.4in, 15mm
  - [K2.0055362](#) 1x Rear Side Bracket Right for ETERNA 55
  - K2.0048324 1x NATO Rail Clamp NRC-2
  - K2.0055230 1x Top Plate for ETERNA 55
  - [K2.0017270](#) 1x Center Camera Handle CCH-4



#### Pro Set for ETERNA 55, [KK.0055439](#)

- includes:
- [K2.0055237](#) 1x Top NATO Rail for ETERNA 55
  - K2.0055230 1x Top Plate for ETERNA 55
  - [K2.0055235](#) 2x Side Bracket for ETERNA 55
  - [K2.0055233](#) 1x Base Plate for ETERNA 55
  - [K2.0055362](#) 1x Rear Side Bracket Right for ETERNA 55
  - [K2.0017270](#) 1x Center Camera Handle CCH-4
  - [K2.66253.0](#) 1x Support Rods 240mm/9.4in, 15mm
  - K2.0048324 1x NATO Rail Clamp NRC-2
  - [K2.66255.0](#) 1x 15mm Reduction Insert
  - [K2.0047776](#) 1x NATO Rail Clamp NRC-1
  - K2.0023549 1x Compact Bridge Plate CBP-5 (19mm)

### Lightweight Configuration



#### Extended Basic Set for ETERNA 55, [K0.0055796](#)

- includes:
- [KK.0055440](#) 1x Basic Set for ETERNA 55
  - K2.0024161 1x Compact Shoulder Pad CSP-2
  - [K2.0054184](#) 2x NATO Rail Clamp NRC-6 (Rosette)
  - K2.0050467 1x Lightweight Support LWS-7
  - [K2.66253.0](#) 1x Support Rods 240mm/9.4in, 15mm
  - [K2.0055362](#) 1x Rear Side Bracket Right for ETERNA 55
  - K2.0048324 1x NATO Rail Clamp NRC-2



#### Basic Set for ETERNA 55, [KK.0055440](#)

- includes:
- [K2.0055237](#) 1x Top NATO Rail for ETERNA 55
  - [K2.66255.0](#) 1x 15mm Reduction Insert
  - [K2.0047776](#) 1x NATO Rail Clamp NRC-1
  - [K2.0055233](#) 1x Base Plate for ETERNA 55
  - [K2.0055235](#) 2x Side Bracket for ETERNA 55
  - [K2.0055367](#) 1x Lightweight Tripod Plate LTP-1



**Lightweight Support LWS-7, K2.0050467**

### ETERNA 55 - Single Components

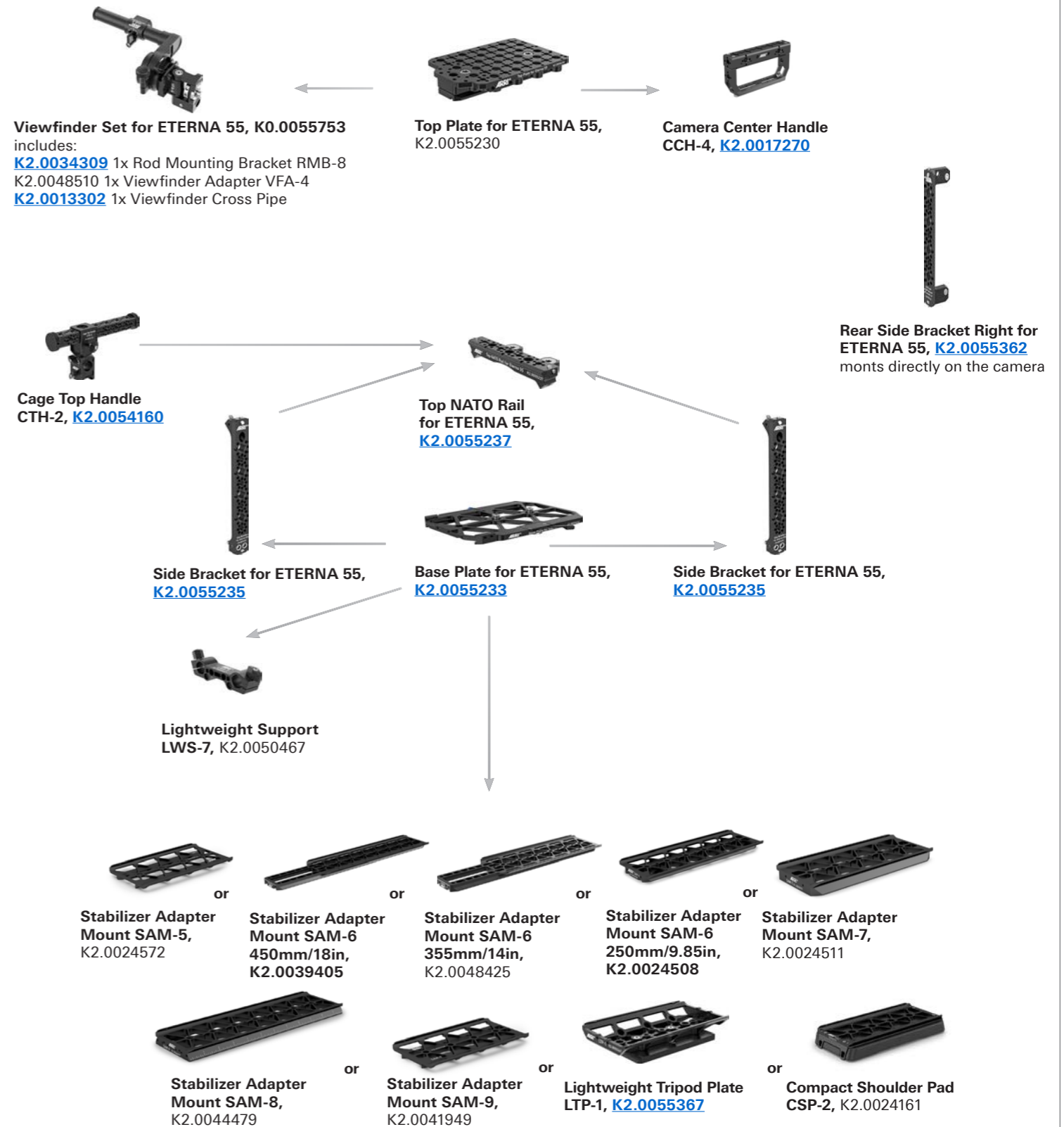

#### Please note:

Due to the height of the Fujifilm ETERNA 55, rods mounted via the Compact Bridge Plates CBP-5/6 and the BPA-6 are positioned approximately 10 mm below the standard heights defined for 15 mm LWS and 15/19 mm studio rod standards. To achieve the standard 15 mm LWS height, the Base Plate for Eterna 55 used together with the LWS-7 provides full compatibility. The 19 mm studio standard height is not supported with this camera configuration.

### NATO Rail Components



**NATO Rail Bar NRB-160**  
[K2.0051823](#)



**NATO Rail Clamp NRC-1, [K2.0047776](#)**



**NATO Rail Clamp NRC-3, [K2.0049419](#)**



**NATO Rail Clamp NRC-5, [K2.0047771](#)**



**Swivel Mechanism Bracket [K2.0052697](#)**



**NATO Rail Clamp NRC-2, K2.0048324**



**NATO Rail Clamp NRC-4, [K2.0047801](#)**



**NATO Rail Clamp NRC-6 (Rosette), [K2.0054184](#)**

## Sets for Sony BURANO

### Basic Cine Set for Sony BURANO, [KK.0050113](#)

includes:  
[K2.0049751](#) 1x Top Plate for Sony BURANO  
[K2.0043726](#) 1x Plate for Sony Venice 1/2  
[K2.0017138](#) 1x Bridge Plate Adapter BPA-5  
[K2.65264.0](#) 1x 15mm LWS Rod Console  
[K2.66253.0](#) 1x Support Rods 240mm/9.4in, 15mm

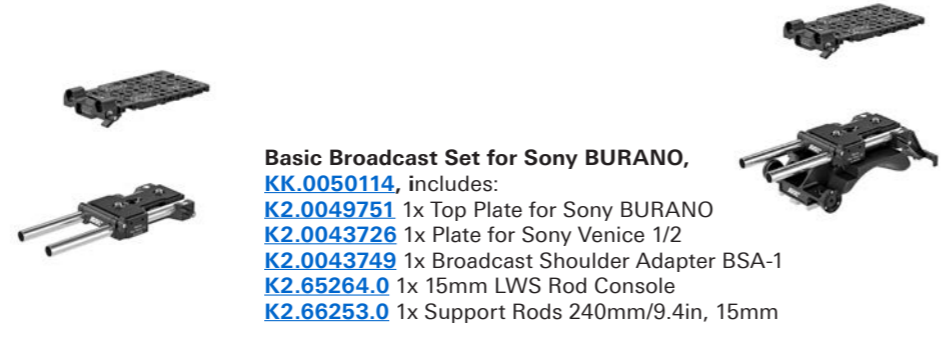

### Basic Broadcast Set for Sony BURANO, [KK.0050114](#)

includes:  
[K2.0049751](#) 1x Top Plate for Sony BURANO  
[K2.0043726](#) 1x Plate for Sony Venice 1/2  
[K2.0043749](#) 1x Broadcast Shoulder Adapter BSA-1  
[K2.65264.0](#) 1x 15mm LWS Rod Console  
[K2.66253.0](#) 1x Support Rods 240mm/9.4in, 15mm



### Pro Cine Set for Sony BURANO, [KK.0050115](#)

includes:  
[K2.0049751](#) 1x Top Plate for Sony BURANO  
[K2.0043726](#) 1x Plate for Sony Venice 1/2  
[K2.0049819](#) 1x Side Bracket Right for Sony BURANO  
[K2.0049816](#) 1x Side Bracket Left for Sony BURANO  
[K2.0049904](#) 1x Rear Side Bracket Right for Sony BURANO  
[K2.0047776](#) 1x NATO Rail Clamp NRC-1  
[K2.0048324](#) 1x NATO Rail Clamp NRC-2  
[K2.0017270](#) 1x Center Camera Handle CCH-4  
[K2.0017138](#) 1x Bridge Plate Adapter BPA-5  
[K2.66255.0](#) 2x 15mm Reduction Insert  
[K2.65264.0](#) 1x 15mm LWS Rod Console  
[K2.66253.0](#) 1x Support Rods 240mm/9.4in, 15mm  
[K2.0006186](#) 1x Rod Mounting Bracket RMB-3

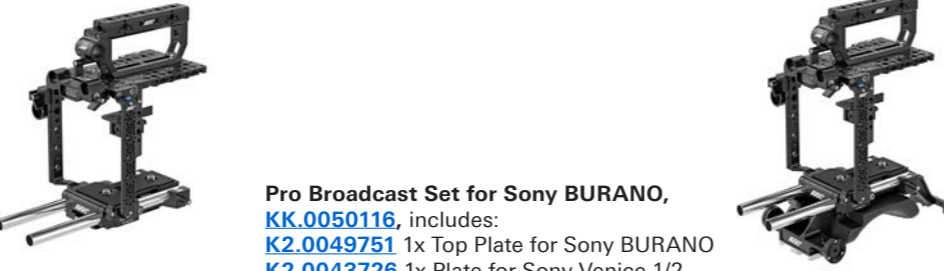

### Pro Broadcast Set for Sony BURANO, [KK.0050116](#)

includes:  
[K2.0049751](#) 1x Top Plate for Sony BURANO  
[K2.0043726](#) 1x Plate for Sony Venice 1/2  
[K2.0049819](#) 1x Side Bracket Right for Sony BURANO  
[K2.0049816](#) 1x Side Bracket Left for Sony BURANO  
[K2.0049904](#) 1x Rear Side Bracket Right for Sony BURANO  
[K2.0047776](#) 1x NATO Rail Clamp NRC-1  
[K2.0048324](#) 1x NATO Rail Clamp NRC-2  
[K2.0017270](#) 1x Center Camera Handle CCH-4  
[K2.0043749](#) 1x Broadcast Shoulder Adapter BSA-1  
[K2.66255.0](#) 2x 15mm Reduction Insert  
[K2.65264.0](#) 1x 15mm LWS Rod Console  
[K2.66253.0](#) 1x Support Rods 240mm/9.4in, 15mm  
[K2.0006186](#) 1x Rod Mounting Bracket RMB-3



## Parts for Sony BURANO



Top Plate for Sony BURANO  
[K2.0049751](#)



NATO Rail Clamp NRC-1  
[K2.0047776](#)



NATO Rail Clamp RC-2  
[K2.0048324](#)



Side Bracket Left for Sony BURANO  
[K2.0049816](#)



Side Bracket Right for Sony BURANO,  
[K2.0049819](#)



Rear Side Bracket Right for Sony BURANO,  
[K2.0049904](#)

## Sets for Sony VENICE 1/2

### Basic Cine Set for Sony Venice 1/2, [KK.0043758](#)

includes:  
[K2.0043699](#) 1x Top Plate for Sony Venice 1/2  
[K2.0043726](#) 1x Plate for Sony Venice 1/2  
[K2.0017138](#) 1x Bridge Plate Adapter BPA-5  
[K2.66252.0](#) 1x Support Rods 340mm/13.4in, 15mm  
[K2.0017270](#) 1x Center Camera Handle CCH-4

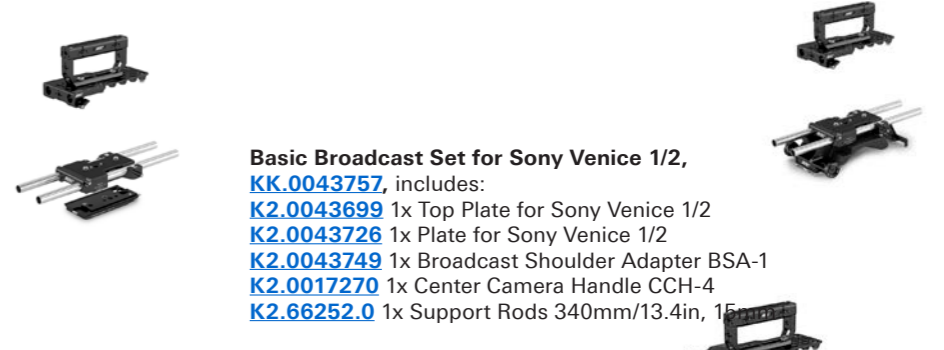

### Basic Broadcast Set for Sony Venice 1/2, [KK.0043757](#)

includes:  
[K2.0043699](#) 1x Top Plate for Sony Venice 1/2  
[K2.0043726](#) 1x Plate for Sony Venice 1/2  
[K2.0043749](#) 1x Broadcast Shoulder Adapter BSA-1  
[K2.0017270](#) 1x Center Camera Handle CCH-4  
[K2.66252.0](#) 1x Support Rods 340mm/13.4in, 15mm



### Pro Cine Set for Sony Venice 1/2, [KK.0043759](#)

includes:  
[K2.0043699](#) 1x Top Plate for Sony Venice 1/2  
[K2.0043726](#) 1x Plate for Sony Venice 1/2  
[K2.0017138](#) 1x Bridge Plate Adapter BPA-5  
[K2.66252.0](#) 1x Support Rods 340mm/13.4in, 15mm  
[K2.0017270](#) 1x Center Camera Handle CCH-4  
[K2.0043731](#) 1x Side Bracket Right for Sony Venice 1/2  
[K2.0043725](#) 1x Side Bracket Left for Sony Venice 1/2  
[K2.0021525](#) 1x EVF Bracket for Sony DVF-EL200 (Venice)  
[K2.0006140](#) 1x Mini Viewfinder Bracket MVB-1

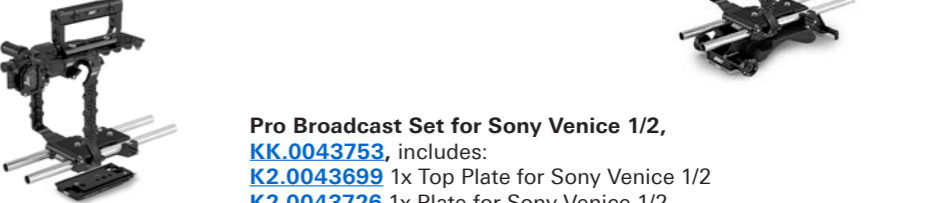

### Pro Broadcast Set for Sony Venice 1/2, [KK.0043753](#)

includes:  
[K2.0043699](#) 1x Top Plate for Sony Venice 1/2  
[K2.0043726](#) 1x Plate for Sony Venice 1/2  
[K2.0043749](#) 1x Broadcast Shoulder Adapter BSA-1  
[K2.66252.0](#) 1x Support Rods 340mm/13.4in, 15mm  
[K2.0017270](#) 1x Center Camera Handle CCH-4  
[K2.0043731](#) 1x Side Bracket Right for Sony Venice 1/2  
[K2.0043725](#) 1x Side Bracket Left for Sony Venice 1/2  
[K2.0021525](#) 1x EVF Bracket for Sony DVF-EL200 (Venice)  
[K2.0006140](#) 1x Mini Viewfinder Bracket MVB-1



## Parts for Sony VENICE 1/2



Top Plate for Sony Venice 1/2  
[K2.0043699](#)



Plate for Sony Venice 1/2  
[K2.0043726](#)



Broadcast Shoulder Adapter BSA-1,  
[K2.0043749](#)



Side Bracket Right for Sony Venice 1/2  
[K2.0043731](#)



Side Bracket Left for Sony Venice 1/2  
[K2.0043725](#)



Rosette Adapter RA-6 (pair)  
[K2.0024574](#)

# Accessories for Sony VENICE Extension Unit 1/2 & Sony VENICE Ext. Mini



Configuration Overview | 5.2.1 / 2025.07

## Sets for Sony VENICE Extension Unit 1/2



**Basic Set for Venice Extension Unit 1/2, KK.0047971** includes:  
[K2.0024564](#) 1x Base Plate for Venice Ext. Unit  
[K2.0039457](#) 1x Top Plate for Venice Ext. Unit  
[K2.0024566](#) 1x Side Bracket Right for Venice Ext. Unit  
[K2.0024761](#) 1x Side Bracket Left for Venice Ext. Unit  
[K2.0024569](#) 1x Cable Clamp for Venice Ext. Unit  
[K2.0024573](#) 1x Back Plate for Venice Ext. Unit  
[K2.0024574](#) 1x Rosette Adapters, RA-6, pair  
[K2.0047941](#) 1x Back Plate 2 for Venice Ext. Unit



**Pro Set for Venice Extension Unit 1/2, KK.0047962**, includes:  
[K2.66253.0](#) 1x Support Rods 240mm/9.4in, 15mm  
[K2.66254.0](#) 1x Support Rods 140mm/5.5in, 15mm  
[K2.66227.0](#) 1x Cage Top Handle, CTH-1  
[K2.66255.0](#) 1x 15mm Reduction Insert  
[K2.65264.0](#) 1x 15mm LWS Rod Console  
[K2.0024564](#) 1x Base Plate for Venice Ext. Unit  
[K2.0039457](#) 1x Top Plate for Venice Ext. Unit  
[K2.0024566](#) 1x Side Bracket Right for Venice Ext. Unit  
[K2.0024761](#) 1x Side Bracket Left for Venice Ext. Unit  
[K2.0024569](#) 1x Cable Clamp for Venice Ext. Unit  
[K2.0024574](#) 1x Rosette Adapters, RA-6, pair  
[K2.0024573](#) 1x Back Plate for Venice Ext. Unit  
 K2.0024965 1x Wooden Handgrip WHG-1  
 K2.0006186 1x Rod Mounting Bracket RMB-3  
[K2.0047941](#) 1x Back Plate 2 for Venice Ext. Unit  
[K2.0017138](#) 1x Bridge Plate Adapter BPA-5

## Sets for Sony VENICE Ext. Mini



**Basic Set for Sony Venice Ext. Mini, KK.0054193** includes:  
[K2.0054187](#) 1x Base Plate for Sony VENICE Ext. Mini  
[K2.0054520](#) 1x Top Plate for Sony VENICE Ext. Mini  
[K2.0054179](#) 2x Side Bracket for Sony VENICE Ext. Mini  
 K2.0054522 2x NATO Rail for Sony VENICE Ext. Mini  
[K2.0054201](#) 1x Cable Clamp for Sony VENICE Ext. Mini  
[K2.0047776](#) 1x NATO Rail Clamp NRC-1  
[K2.66255.0](#) 1x 15mm Reduction Insert



**Pro Set for Sony Venice Ext. Mini, KK.0054192** includes:  
[K2.0054187](#) 1x Base Plate for Sony VENICE Ext. Mini  
[K2.0054520](#) 1x Top Plate for Sony VENICE Ext. Mini  
[K2.0054189](#) 1x Back Plate for Sony VENICE Ext. Mini  
[K2.0054179](#) 2x Side Bracket for Sony VENICE Ext. Mini  
 K2.0054522 3x NATO Rail for Sony VENICE Ext. Mini  
[K2.0054201](#) 1x Cable Clamp for Sony VENICE Ext. Mini  
[K2.0054184](#) 2x NATO Rail Clamp NRC-6 (Rosette)  
[K2.66255.0](#) 1x 15mm Reduction Insert  
 K2.0024745 1x Bridge Plate Adapter BPA-6  
[K2.0054160](#) 1x Cage Top Handle CTH-2  
[K2.0047776](#) 1x NATO Rail Clamp NRC-1  
[K2.0054216](#) 1x Wooden Handle Grip WHG-3 right  
[K2.0054215](#) 1x Wooden Handle Grip WHG-3 left  
[K2.66254.0](#) 1x Support Rods 140mm/5.5in, 15mm

## Parts for Sony VENICE Extension Unit 1/2



Base Plate for Venice Ext. Unit, [K2.0024564](#)



Top Plate for Venice Ext. Unit, [K2.0039457](#)



Cable Clamp for Venice Ext. Unit [K2.0024569](#)

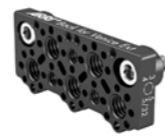

Back Plate for Venice Ext. Unit [K2.0024573](#)



Back Plate 2 for Venice Ext. Unit, [K2.0047941](#)



Side Bracket Left for Venice Ext. Unit [K2.0024761](#)



Side Bracket Right for Venice Ext. Unit, [K2.0024566](#)

## Parts for Sony VENICE Ext. Mini



Top Plate for Sony VENICE Ext. Mini, [K2.0054520](#)



Base Plate for Sony VENICE Ext. Mini, [K2.0054187](#)



Back Plate for Sony VENICE Ext. Mini, [K2.0054189](#)



Side Bracket for Sony VENICE Ext. Mini, [K2.0054179](#)



Cable Clamp for Sony VENICE Ext. Mini, [K2.0054201](#)



NATO Rail Clamp NRC-6 (Rosette), [K2.0054184](#)



Cage Top Handle CTH-2, [K2.0054160](#)



Wooden Handgrip WHG-3 right, [K2.0054216](#)



Wooden Handgrip WHG-3 left, [K2.0054215](#)

for more compatible NATO Rail parts please see Config 5.6.1

# Compatibility of Accessories for Sony VENICE Ext. Mini parts



Configuration Overview | 5.2.2 / 2025.04

## Compatibility Base Plate for Sony VENICE Ext. Mini

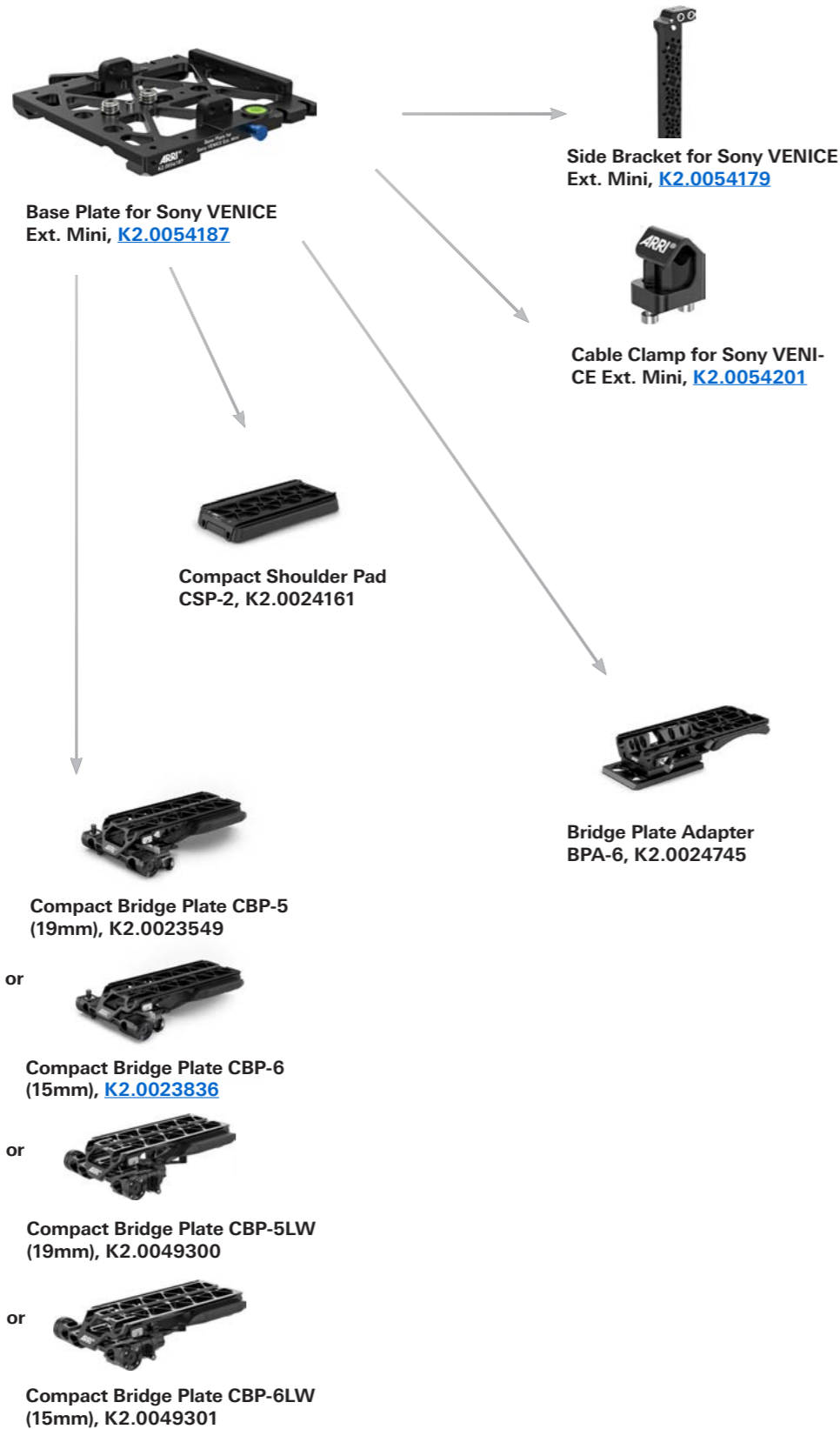

## Compatibility Top Plate for Sony VENICE Ext. Mini



## Compatibility Back Plate for Sony VENICE Ext. Mini

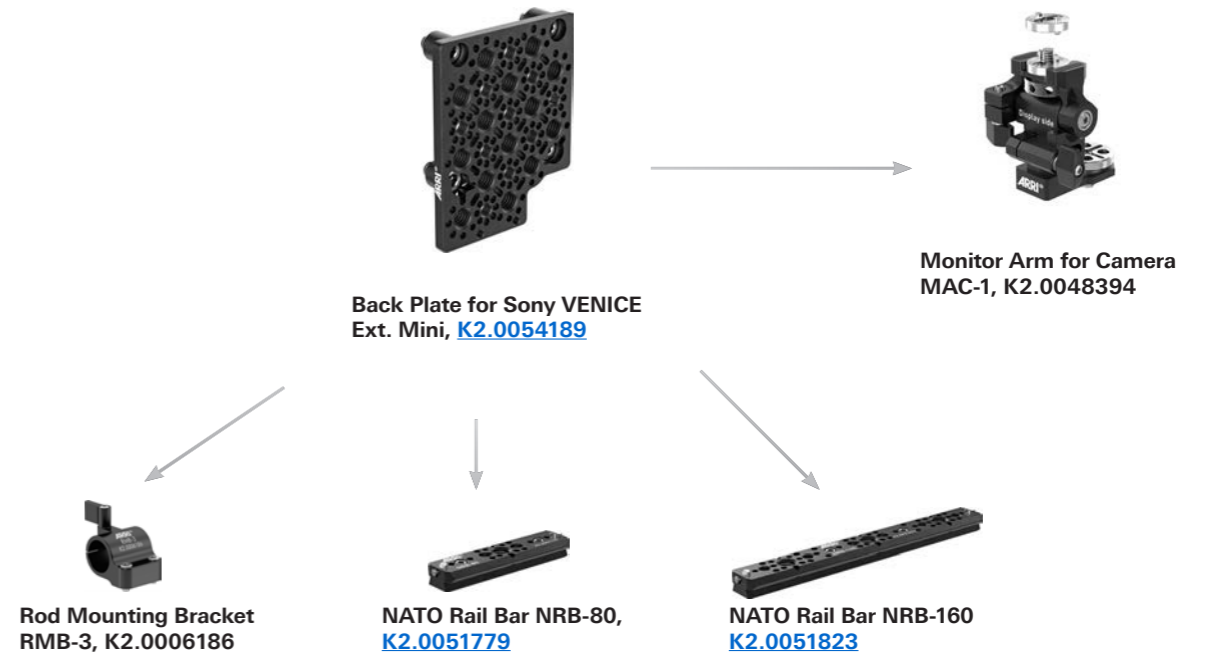

## Sets for Canon EOS C300 MkIII / C500 MkII



**Basic Set for Canon C300 MkIII / C500 MkII** [KK.0033625](#)  
 Consists of:  
 Plate for Canon C300 Mk III / C500 MkII [K2.0033439](#)  
 Bridge Plate Adapter BPA-5 [K2.0017138](#)  
 Support Rods 340mm, Ø15mm [K2.66252.0](#)



**Pro Set for Canon C300 MkIII / C500 MkII** [KK.0037326](#)  
 Consists of:  
 Top Plate for Canon C300 MkIII / C500 MkII [K2.0033441](#)  
 Plate for Canon C500 MkII [K2.0033439](#)  
 Bridge Plate Adapter BPA-5 [K2.0017138](#)  
 Camera Center Handle CCH-4 [K2.0017270](#)  
 Sliding Adapter for CCH-4 [K2.0019282](#)  
 Rod Mounting Bracket RMB-3 [K2.0006186](#)  
 15mm Reduction Insert [K2.66255.0](#)  
 Mini Viewfinder Bracket MVB-1 [K2.0006140](#)  
 Bracket for Canon LM-V1 [K2.0015520](#)  
 Support Rods 340mm, Ø15mm [K2.66252.0](#)  
 Side Bracket Left for C300 MkIII / C500 MkII [K2.0037185](#)  
 Side Bracket Right for C300 MkIII / C500 MkII [K2.0037183](#)



**Plate for Canon C300 MkIII / C500 MkII,** [K2.0033439](#)

**Top Plate for Canon C300 MkIII / C500 MkII,** [K2.0033441](#) \*



**Side Bracket Left for C300 MkIII / C500 MkII** [K2.0037185](#)

**Side Bracket Right for C300 MkIII / C500 MkII** [K2.0037183](#)

\* discontinued items  
no stock available anymore

## Sets for Canon C300 / C300 Mk II / C500



**Basic Cine Set for Canon C300 Mk II** [KK.0007700](#)  
 Consists of:  
 Cine Plate C300 MkII [K2.0006864](#)  
 Support Rods 340 mm (13.4"), Ø 15 mm [K2.66252.0](#)  
 Shoulder Pad CSP-1 [K2.0006807](#)

**Pro Cine Set for Canon C300 Mk II** [KK.0007705](#)  
 Consists of:  
 Cine Plate C300 MkII [K2.0006864](#)  
 Support Rods 340 mm (13.4"), Ø 15 mm [K2.66252.0](#)  
 Top Plate C300 MkII [K2.0006859](#)  
 Center Camera Handle, CCH-2 [K2.73002.0](#)  
 3/8" Accessory Shoe Adapter, 18.65mm square [K2.54077.0](#)  
 Shoulder Pad CSP-1 [K2.0006807](#)

**Pro Cine Set for Canon C300 Mk II + BP-8** [KK.0007703](#)  
 Consists of:  
 Cine Plate C300 MkII [K2.0006864](#)  
 Support Rods 340 mm (13.4"), Ø 15 mm [K2.66252.0](#)  
 Top Plate C300 MkII [K2.0006859](#)  
 Center Camera Handle, CCH-2 [K2.73002.0](#)  
 Bridge Plate BP-8 Set (19 mm Rods) [K2.47090.0](#)  
 3/8" Accessory Shoe Adapter, 18.65mm square [K2.54077.0](#)  
 Shoulder Pad CSP-1 [K2.0006807](#)

**Pro Cine Set for Canon C300 Mk II + BP-9** [KK.0007704](#)  
 Consists of:  
 Cine Plate C300 MkII [K2.0006864](#)  
 Support Rods 340 mm (13.4"), Ø 15 mm [K2.66252.0](#)  
 Top Plate C300 MkII [K2.0006859](#)  
 Center Camera Handle, CCH-2 [K2.73002.0](#)  
 Bridge Plate BP-9 Set (15 mm Rods) [K2.47091.0](#)  
 3/8" Accessory Shoe Adapter, 18.65mm square [K2.54077.0](#)  
 Shoulder Pad CSP-1 [K2.0006807](#)

**Pro Broadcast Set for Canon C300 Mk II** [KK.0007702](#)  
 Consists of:  
 Broadcast Plate C300 MkII [K2.0006797](#)  
 Support Rods 340 mm (13.4"), Ø 15 mm [K2.66252.0](#)  
 Top Plate C300 MkII [K2.0006859](#)  
 Center Camera Handle, CCH-2 [K2.73002.0](#)  
 3/8" Accessory Shoe Adapter, 18.65mm square [K2.54077.0](#)

**Basic Broadcast Set for Canon C300 Mk II** [KK.0007699](#)  
 Consists of:  
 Broadcast Plate C300 MkII [K2.0006797](#)  
 Support Rods 340 mm (13.4"), Ø 15 mm [K2.66252.0](#)

**Pro Broadcast Set for Canon C300 Mk II + QRP-1,** [KK.0007701](#)  
 Consists of:  
 Broadcast Plate C300 MkII [K2.0006797](#)  
 Support Rods 340 mm (13.4"), Ø 15 mm [K2.66252.0](#)  
 Top Plate C300 MkII [K2.0006859](#)  
 Center Camera Handle, CCH-2 [K2.73002.0](#)  
 Quick Release Plate, QRP-1 [K2.0000399](#)  
 3/8" Accessory Shoe Adapter, 18.65mm square [K2.54077.0](#)

## Sets for Canon C200

**Basic Cine Set for Canon C200** [KK.0016044](#)  
 Consists of:  
 Adapter Plate for Canon C200 [K2.0015518](#)  
 Cine Plate C300 Mk II [K2.0006864](#)  
 Support Rods 340 mm (13.4 inch), Ø 15 mm [K2.66252.0](#)  
 Shoulder Pad CSP-1 [K2.0006807](#)

**Pro Cine Set for Canon C200** [KK.0016051](#)  
 Consists of:  
 Adapter Plate for Canon C200 [K2.0015518](#)  
 Cine Plate C300 Mk II [K2.0006864](#)  
 Support Rods 340 mm (13.4 inch), Ø 15 mm [K2.66252.0](#)  
 Top Plate for Canon C200 [K2.0015513](#)  
 Center Camera Handle, CCH-2 [K2.73002.0](#)  
 Shoulder Pad CSP-1 [K2.0006807](#)  
 Monitor Bracket for Canon C200 [K2.0015520](#)  
 Viewfinder Mounting Bracket MVB-1 [K2.0006140](#)

**Pro Broadcast Set for Canon C200 + QRP-1** [KK.0016052](#)  
 Consists of:  
 Adapter Plate for Canon C200 [K2.0015518](#)  
 Broadcast Plate C300 Mk II [K2.0006797](#)  
 Support Rods 340 mm (13.4 inch), Ø 15 mm [K2.66252.0](#)  
 Top Plate for Canon C200 [K2.0015513](#)  
 Center Camera Handle, CCH-2 [K2.73002.0](#)  
 Quick Release Plate, QRP-1 [K2.0000399](#)  
 Monitor Bracket for Canon C200 [K2.0015520](#)  
 Viewfinder Mounting Bracket MVB-1 [K2.0006140](#)



**Adapter Plate for Canon C200** [K2.0015518](#) \*



**Top Plate for Canon C200** [K2.0015513](#) \*



**Monitor Bracket for Canon C200** [K2.0015520](#) \*

\* discontinued items  
only as long as stock is available (single item)

## Viewfinder Brackets for Canon



**Viewfinder Bracket for Canon C700,** [K2.0013195](#)



**EVF bracket for Canon Monitor Unit,** [K2.0008955](#)

## Sets for Canon C700

**Pro Set for Canon C700** [KK.0013598](#)  
 Consists of:  
 Plate for Canon C700 [K2.0013191](#)  
 Support Rods 240 mm (9.4 inch), Ø 15 mm [K2.66253.0](#)  
 Top Plate for Canon C700 [K2.0013229](#)  
 Viewfinder mounting bracket Mini (MVB-1) [K2.0006140](#)  
 Viewfinder bracket for Canon C700 [K2.0013195](#)  
 Center Camera Handle, CCH-2 [K2.73002.0](#)

**Cine 19mm Pro Set for Canon C700** [KK.0013597](#)  
 Consists of:  
 Plate for Canon C700 [K2.0013191](#)  
 Support Rods 240 mm (9.4 inch), Ø 15 mm [K2.66253.0](#)  
 Top Plate for Canon C700 [K2.0013229](#)  
 Viewfinder mounting bracket Mini (MVB-1) [K2.0006140](#)  
 Viewfinder bracket for Canon C700 [K2.0013195](#)  
 Center Camera Handle, CCH-2 [K2.73002.0](#)  
 Bridge Plate BP-8 Set (19 mm Rods) [K2.47090.0](#)

**Cine 15mm Pro Set for Canon C700** [KK.0013599](#)  
 Consists of:  
 Plate for Canon C700 [K2.0013191](#)  
 Support Rods 240 mm (9.4 inch), Ø 15 mm [K2.66253.0](#)  
 Top Plate for Canon C700 [K2.0013229](#)  
 Viewfinder mounting bracket Mini (MVB-1) [K2.0006140](#)  
 Viewfinder bracket for Canon C700 [K2.0013195](#)  
 Center Camera Handle, CCH-2 [K2.73002.0](#)  
 Bridge Plate BP-9 Set (15 mm Rods) [K2.47091.0](#)

**Broadcast Pro Set for Canon C700** [KK.0013596](#)  
 Consists of:  
 Plate for Canon C700 [K2.0013191](#)  
 Support Rods 240 mm (9.4 inch), Ø 15 mm [K2.66253.0](#)  
 Top Plate for Canon C700 [K2.0013229](#)  
 Viewfinder mounting bracket Mini (MVB-1) [K2.0006140](#)  
 Viewfinder bracket for Canon C700 [K2.0013195](#)  
 Center Camera Handle, CCH-2 [K2.73002.0](#)  
 Quick Release Plate, QRP-1 [K2.0000399](#)



**Plate for Canon C700** [K2.0013191](#)



**Top Plate for Canon C700** [K2.0013229](#)



**Viewfinder Bracket for Canon C700,** [K2.0013195](#)



**Handgrip Adapter HGA-1 Set LBS-2** [KK.0005673](#)  
 Consists of (without rods):  
 Handgrip Adapter, HGA-1 [K2.66191.0](#)  
 Lightweight Bridge Support, LBS-2 [K2.66275.0](#)

# Accessories for Canon Camera EOS C400 & compatible Nato Rail System



Configuration Overview | 5.3.1 / 2025.04

## Sets for Canon EOS C400



### Basic Cine Set for Canon EOS C400

Consists of:  
 Top Plate for Canon EOS C400  
 Plate for Canon EOS C400  
 Bridge Plate Adapter BPA-5  
 15mm LWS Rod Console  
 Support Rods 240mm/9.4in, Ø15mm

[KK.0051657](#)

[K2.0051221](#)  
[K2.0051262](#)  
[K2.0017138](#)  
[K2.65264.0](#)  
[K2.66253.0](#)



### Basic Broadcast Set for Canon EOS C400

Consists of:  
 Top Plate for Canon EOS C400  
 Plate for Canon EOS C400  
 Broadcast Shoulder Adapter BSA-1  
 15mm LWS Rod Console  
 Support Rods 240mm/9.4in, Ø15mm

[KK.0051659](#)

[K2.0051221](#)  
[K2.0051262](#)  
[K2.0043749](#)  
[K2.65264.0](#)  
[K2.66253.0](#)



### Pro Cine Set for Canon C400

Consists of:  
 Top Plate for Canon EOS C400  
 Plate for Canon EOS C400  
 Bridge Plate Adapter BPA-5  
 Center Camera Handle CCH-4  
 Side Bracket Right for Canon EOS C400  
 Side Bracket Left for Canon EOS C400  
 Rear Side Bracket Right for Canon EOS C400  
 NATO Rail Clamp NRC-1  
 NATO Rail Clamp NRC-2  
 Rod Mounting Bracket RMB-3  
 Support Rods 240mm/9.4in, Ø15mm  
 15mm LWS Rod Console  
 15mm Reduction Insert (2x)

[KK.0051661](#)

[K2.0051221](#)  
[K2.0051262](#)  
[K2.0017138](#)  
[K2.0017270](#)  
[K2.0051223](#)  
[K2.0051222](#)  
[K2.0051224](#)  
[K2.0047776](#)  
[K2.0048324](#)  
[K2.0006186](#)  
[K2.66253.0](#)  
[K2.65264.0](#)  
[K2.66255.0](#)



### Pro Broadcast Set for Canon EOS C400

includes:  
 Top Plate for Canon EOS C400  
 Plate for Canon EOS C400  
 Broadcast Shoulder Adapter BSA-1  
 Center Camera Handle CCH-4  
 Side Bracket Right for Canon EOS C400  
 Side Bracket Left for Canon EOS C400  
 Rear Side Bracket Right for Canon EOS C400  
 NATO Rail Clamp NRC-1  
 NATO Rail Clamp NRC-2  
 Rod Mounting Bracket RMB-3  
 Support Rods 240mm/9.4in, Ø15mm  
 15mm Reduction Insert (2x)  
 15mm LWS Rod Console

[KK.0051662](#)

[K2.0051221](#)  
[K2.0051262](#)  
[K2.0043749](#)  
[K2.0017270](#)  
[K2.0051223](#)  
[K2.0051222](#)  
[K2.0051224](#)  
[K2.0047776](#)  
[K2.0048324](#)  
[K2.0006186](#)  
[K2.66253.0](#)  
[K2.66255.0](#)  
[K2.65264.0](#)

## Parts for Canon C400



Top Plate for Canon EOS C400, [K2.0051221](#)



Plate for Canon EOS C400, [K2.0051262](#)



Side Bracket Right for Canon EOS C400  
[K2.0051223](#)



Side Bracket Left for Canon EOS C400  
[K2.0051222](#)



Rear Side Bracket Right for Canon EOS C400  
[K2.0051224](#)

## Recommended Parts for Canon C400



Viewfinder Cross Pipe,  
[K2.0013302](#)



Rosette Adapters, RA-6,  
 pair, [K2.0024574](#)



EVF Bracket for Canon LM-V1/2, [K2.0015520](#) \*



Cage Top Handle CTH-2,  
[K2.0054160](#)



Wooden Handgrip WHG-3  
 right, [K2.0054216](#)



Wooden Handgrip WHG-3  
 left, [K2.0054215](#)

\* discontinued items  
 only as long as stock is available (single item)

## NATO Rail Sets



NATO Accessory Rail NRC-5 Set Pro, [KK.0051127](#)  
 includes:  
[K2.0047643](#) 1x NATO Accessory Rail NAR-30  
[K2.0047854](#) 1x NATO Accessory Rail NAR-60  
[K2.0047631](#) 1x NATO Accessory Rail NAR-90  
[K2.0047771](#) 1x NATO Rail Clamp NRC-5  
[K2.0050106](#) 1x 1/4in Slide for NAR-60/90  
[K2.0050107](#) 1x Double M4 Slide for NAR-60/90

NATO Accessory Rail NRC-5 Set Basic, [KK.0051126](#)  
 includes:  
[K2.0047643](#) 1x NATO Accessory Rail NAR-30  
[K2.0047854](#) 1x NATO Accessory Rail NAR-60  
[K2.0047631](#) 1x NATO Accessory Rail NAR-90  
[K2.0047771](#) 1x NATO Rail Clamp NRC-5

NATO Accessory Rail NAR-30/NRC-5 Set, [KK.0051123](#)  
 includes:  
[K2.0047643](#) 1x NATO Accessory Rail NAR-30  
[K2.0047771](#) 1x NATO Rail Clamp NRC-5

NATO Accessory Rail NAR-60/NRC-5 Set, [KK.0051124](#)  
 includes:  
[K2.0047854](#) 1x NATO Accessory Rail NAR-60  
[K2.0047771](#) 1x NATO Rail Clamp NRC-5

NATO Accessory Rail NAR-90/NRC-5 Set, [KK.0051125](#)  
 includes:  
[K2.0047631](#) 1x NATO Accessory Rail NAR-90  
[K2.0047771](#) 1x NATO Rail Clamp NRC-5

## NATO Rail Parts



NATO Accessory Rail NAR-30  
[K2.0047643](#)



NATO Accessory Rail NAR-60  
[K2.0047854](#)



NATO Accessory Rail NAR-90  
[K2.0047631](#)



3/8in Slide for NAR-60/90  
[K2.0050105](#)



1/4in Slide for NAR-60/90  
[K2.0050106](#)



Double M4 Slide for NAR-60/90  
[K2.0050107](#)



NATO Rail Clamp NRC-1,  
[K2.0047776](#)



NATO Rail Clamp NRC-2,  
[K2.0048324](#)



NATO Rail Clamp NRC-3,  
[K2.0049419](#)



NATO Rail Clamp NRC-4  
[K2.0047801](#)













NATO Rail Clamp NRC-5  
[K2.0047771](#)



NATO Rail Clamp NRC-6  
 (Rosette), [K2.0054184](#)

for more compatible  
 NATO Rail sets and parts  
 please see Config 5.6.1

## Rosette Adapters

 Rosette Adapter RA-1 (pair), <a href="#">K2.66174.0</a>	 Rosette Adapter RA-2 (pair), <a href="#">K2.65269.0</a>	 Rosette Adapter RA-3 (pair), <a href="#">K2.65268.0</a>	 Rosette Adapter RA-4, <a href="#">K2.0014825</a>	 Rosette Adapter RA-5, <a href="#">K2.0024563</a> *
 Rosette Adapter RA-6 (pair), <a href="#">K2.0024574</a>	 Extension Spacer 50 mm, <a href="#">K2.0013615</a>	 Rosette Extension REX-25, <a href="#">K2.0048040</a>	 Rosette Extension REX-40, <a href="#">K2.0049430</a>	 Rod Clamp for REX-40, <a href="#">K2.0048099</a>

 **Rosette Extension REX-40 Set**  
KK.0049433, Includes:  
[K2.0048099](#) 1x Rod Clamp for REX-40  
[K2.0049430](#) 1x Rosette Extension REX-40  
[K2.66255.0](#) 1x 15mm Reduction Insert

\* discontinued items  
no stock available anymore

## Arrihead



**ARRIHEAD 2**  
with integrated encoders,  
without encoders, [K2.43670.0](#)

Reduction Gear, [K2.34301.0](#)  
Wedge Plate, K2.47171.0  
Handwheel, big, K2.47001.0

## Bridge Plate Sled

**Bridge Plate Sled BPS-2 Set**  
KK.0005813, includes:



**Bridge Plate Sled BPS-2**  
[K2.66260.0](#)

**Bottom Dovetail Plate 300mm/12in**  
[K2.0015896](#)

## Bridge Plate

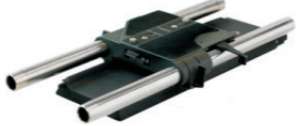

**Bridge Plate Set BP-8**  
19 mm, K2.47090.0



**Bridge Plate Set BP-9**  
15 mm, [K2.47091.0](#)



**Bridge Plate BP-8**  
19 mm, [K2.0031436](#)



**Bridge Plate BP-9**  
15 mm, [K2.0031435](#)

## LWS Shoulder Support



**Universal Shoulder Pad**  
for 15mm rods USP-2,  
K2.66209.0  
(incl. UMB-1 and straight foam)



**Universal Mounting Bracket**  
for 15mm rods (UMB-1)  
K2.66168.0



**Camera Shoulder Pad**  
CSP-1, [K2.0006807](#)

## Support Accessories



**Shoulder Belt Adapters**  
SBA-1, [K2.0001223](#)



**Microphone Bracket Holder**  
MBH-1 [K2.66256.0](#)



**Lightweight Bridge Support**  
LBS-2, [K2.66275.0](#)



**Universal Bridge Support**  
UBS-3, [K2.0013320](#)



**Rod Mounting Bracket RMB-9**  
[K2.0049530](#)

## Quick Release HD



**Quick Release Plate**  
QRP-1, [K2.0000399](#)

## Quick Release HD



**19mm Adapter for Sony F5/F55**, K2.66271.0



**Quick Release HD Baseplate**  
[K2.47796.0](#)



**Support Rod Holder**  
19 mm, K2.47798.0  
**Support Rod Holder**  
15 mm, K2.47799.0



**Bridge Plate Sled**  
BPS-1, [K2.47797.0](#)



**Bottom Plates**

## Bottom Plates



**Bottom Dovetail Plate 150mm/6in**  
[K2.0020427](#)



**Bottom Dovetail Plate 300mm/12in**  
[K2.0015896](#)



**Bottom Dovetail Plate 450mm/18in**  
[K2.0015950](#)



**Bottom Dovetail Plate 600mm/24in**  
[K2.0015952](#)



**Rod Support Bracket RSB-15**, [K2.0000437](#)  
**Rod Support Bracket RSB-19**, [K2.0000440](#)

## Lens Support



**Lens Support LS-9** for 19 mm rods  
[K2.47227.0](#)



**Lens Support LS-10** for 15 mm rods  
[K2.47228.0](#)



**Lightweight Lens Support LLS-1** for 15 mm rods,  
[K2.0017029](#)



**Lightweight Lens Support LLS-1 Set**, [KK.0047392](#)



**LLS-1 Pin**, [K2.0038782](#)



**LLS-1 Pin Small**, [K2.0047386](#)

## Top Handles



Cage Top Handle CTH-1, [K2.66227.0](#)



Cage Top Handle CTH-2, [K2.005416.0](#)



Lightweight Camera Handle LCH-1, [K2.002406.6](#)



Camera Center Handle CCH-4, [K2.001727.0](#)



Center Camera Handle CCH-2, [K2.73002.0](#)

## Handle Support

### Handle Extension Set, KK.0037820 includes:

- [K2.001979.1](#) 1x Handle Extension HEX-1
- [K2.001979.2](#) 1x Handle Extension HEX-2
- [K2.001979.7](#) 1x Handle Extension HEX-3
- [K2.001979.8](#) 1x Handle Extension HEX-4
- [K2.003691.7](#) 1x Handle Extension HEX-5
- [K2.001981.0](#) 1x Handle Extension HEX-90
- [K2.003713.1](#) 1x Wooden Shell for HEX
- [K2.003713.2](#) 1x Plastic Shell for HEX



### Handle Extension Set for ALEXA 35, KK.0051730, includes:

- [K2.001979.1](#) 1x Handle Extension HEX-1
- [K2.001979.2](#) 1x Handle Extension HEX-2
- [K2.001979.7](#) 1x Handle Extension HEX-3
- [K2.001979.8](#) 1x Handle Extension HEX-4
- [K2.003691.7](#) 1x Handle Extension HEX-5
- [K2.001981.0](#) 1x Handle Extension HEX-90
- [K2.003713.1](#) 1x Wooden Shell for HEX
- [K2.004905.0](#) 1x Handle Extension HEX-A



Handle Extension HEX-1, [K2.001979.1](#)



Handle Extension HEX-2, [K2.001979.2](#)



Handle Extension HEX-3, [K2.001979.7](#)



Handle Extension HEX-4, [K2.001979.8](#)



Handle Extension HEX-5, [K2.003691.7](#)



Handle Extension HEX-90, [K2.001981.0](#)



Handle Extension HEX-A, [K2.004905.0](#)



Handle Extension Block HEB-1, [K2.000101.6](#)



Handle Extension Block long, HEB-3, [K2.000101.7](#)



CCH-2 Support, [K2.003817.6](#)



Wooden Shell for HEX [K2.003713.1](#)



Plastic Shell for HEX [K2.003713.2](#)



Bicycle Grip Adapter BGA-1, [K2.003424.8](#)



Bicycle Grip Adapter BGA-2, [K2.003662.3](#)

## Handgrip Support



### Rosette Extension REX-40 Set

- KK.0049433, Includes:
- [K2.004809.9](#) 1x Rod Clamp for REX-40
  - [K2.004943.0](#) 1x Rosette Extension REX-40
  - [K2.66255.0](#) 1x 15mm Reduction Insert



Rosette Extension REX-25, [K2.004804.0](#)



Rosette Extension REX-40, [K2.004943.0](#)



Rod Clamp for REX-40, [K2.004809.9](#)



Extension Tube [K2.47136.0](#)



Extension Spacer 50 mm, [K2.001361.5](#)



15 mm Cable Clip [K2.001292.1](#)



Handgrip Extension 80 mm, [K2.001291.3](#)



Handgrip Extension 160 mm, [K2.001291.1](#)



Handgrip Extension 240 mm, [K2.001291.7](#)

## Handgrip Sets and Parts

**UBS-3 Handgrip Set** without on/off, [KK.000567.5](#), includes:  
[K2.47861.0](#) 2x Handgrip without on/off switch  
 K2.47863.0 2x Handgrip Extension, long  
[K2.001332.0](#) 1x Universal Bridge Support UBS-3



**LBS-2 Handgrip Set** without on/off, [KK.000567.4](#), includes:  
[K2.47861.0](#) 2x Handgrip without on/off switch  
 K2.47863.0 2x Handgrip Extension, long  
[K2.66275.0](#) 1x Lightweight Bridge Support LBS-2



**UBS-3 Handgrip Set on/off RS 3-pin**, [KK.000567.7](#), includes:  
[K2.47861.0](#) 1x Handgrip without on/off switch  
[K2.47862.0](#) 1x Handgrip with on/off switch RS-3 pin  
 K2.47863.0 2x Handgrip Extension, long  
[K2.001332.0](#) 1x Universal Bridge Support UBS-3



**LBS-2 Handgrip Set on/off RS 3-pin**, [KK.000567.6](#), includes:  
[K2.47861.0](#) 1x Handgrip without on/off switch  
[K2.47862.0](#) 1x Handgrip with on/off switch RS-3 pin  
 K2.47863.0 2x Handgrip Extension, long  
[K2.66275.0](#) 1x Lightweight Bridge Support LBS-2



**Handgrip Set Right**, [KK.000571.0](#), includes:  
[K2.45886.0](#) 1x Standard righthand articulating Handgrip  
 K2.47863.0 1x Handgrip Extension, long



Wooden Handgrip WHG-3 right, [K2.005421.6](#)



Wooden Handgrip WHG-3 left, [K2.005421.5](#)



Wooden Handgrips WHG-2 (Pair) [K2.005212.4](#)



Mountable Run Stop Button MRS-1, [K2.004500.6](#)



Cable RRS-1 (0.8m/2.6ft) [K2.005132.6](#)

Cable RS/PWR IN - LANC [K2.004998.4](#)



Handgrip without on/off switch, [K2.47861.0](#)



Handgrip with on/off switch RS-3 pin, [K2.47862.0](#)



Handgrip with on/off switch Hirose 4-pin, [K2.66278.0](#)



Standard Grip Left SGL-1, [K2.001631.7](#)



Standard Grip Right SGR-1, [K2.001631.8](#)



Standard righthand articulating Handgrip [K2.45886.0](#)









## Brackets for Rods

-  **LSA-1 Lighting Spigot Adapter**  
[K2.0014833](#)
-  **Rod Mounting Bracket RMB-5**  
[K2.0014827](#)
-  **Rod Mounting Bracket RMB-6**  
[K2.0020163](#) \*
-  **Rod Mounting Bracket RMB-6 set**  
[KK.0020673](#)
-  **Multi Interface Adapter MIA-1**  
K2.0014323
-  **Rod Mounting Bracket RMB-8**  
[K2.0034309](#)
-  **Rod Mounting Bracket RMB-8 Set**  
[KK.0037732](#)
-  **Rod Mounting Bracket RMB-2, \***  
KK.0005807
-  **Dovetail Insert Rod Bracket for WHA**, K2.52150.0
-  **WHA-2 Rosette Bracket**  
[K2.52153.0](#)
-  **Rod Mounting Bracket RMB-3**, K2.0006186

## Adapters with Rosette

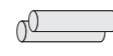
-  **Rosette Adapter RA-1 (pair)**  
[K2.66174.0](#)
-  **Rosette Adapter RA-2 (pair)**  
[K2.65269.0](#)
-  **Rosette Adapter RA-3 (pair)**  
[K2.65268.0](#)
-  **Rosette Adapter RA-4**  
[K2.0014825](#)
-  **Rosette Adapter RA-5**  
[K2.0024563](#)
-  **Rosette Adapter RA-6 (pair)**  
[K2.0024574](#)
-  **Extension Spacer 50 mm**  
[K2.0013615](#)

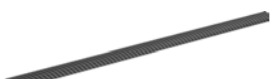
## 19 mm Studio Rods

-  **540 mm, [K2.72028.0](#)**  
stainless steel
-  **440 mm, [K2.0001022](#)**  
stainless steel
-  **340 mm, [K2.66269.0](#)**  
stainless steel, lightweight
-  **240 mm, [K2.66270.0](#)**  
stainless steel, lightweight
-  **150 mm, [K2.0016090](#)**  
stainless steel, lightweight
-  **90 mm, [K2.0016088](#)**  
stainless steel, lightweight
-  **Single Support Rods 540 mm**  
[K2.0014959](#), carbon fibre, black
-  **Single Support Rods 340 mm**  
[K2.0014954](#), carbon fibre, black





## Monitor Mounting

-  **Univ. Mounting Arm, UMA-120**  
[K2.65020.0](#)
-  **Monitor Arm MMA-65**  
[K2.41101.0](#)  
recommended for HDM-7
-  **Univ. Mounting Arm, UMA-240**  
[K2.41100.0](#)
-  **Adjustable Monitor Mount AMM-1**  
[K2.0014829](#)
-  **Monitor Adapter for Transvideo**  
[K2.0014831](#)
-  **Monitor Adapter for Small HD**  
[K2.0014832](#)









## Recorder / Battery Bracket

-  **Battery Adapter Plate BAP-1**  
[K2.0006471](#)

## 15 mm Studio Rods

-  **540 mm, [K2.72029.0](#)**  
stainless steel
-  **440 mm, [K2.0001031](#)**  
stainless steel
-  **340 mm, [K2.66252.0](#)**  
stainless steel, lightweight
-  **240 mm, [K2.66253.0](#)**  
stainless steel, lightweight
-  **140 mm, [K2.66254.0](#)**  
stainless steel, lightweight

## Brackets

-  **Quick Change Adapter 3/8",** [K2.52080.0](#)
-  **Dovetail Insert, 3/8 inch thread,** [K2.52082.0](#)
-  **Dovetail Shoe, 3/8 inch thread,** [K2.52083.0](#)
-  **Microphone Holder Bracket MHB-1,** [K2.66256.0](#)
-  **L-Bracket,** [K2.0001967](#)
-  **V-Plate,** [K2.0001758](#)
-  **3/8" Thread Adapter**  
[K2.0014893](#)
-  **3/8" Accessory Shoe**  
[K2.54077.0](#)
-  **Shoulder Belt Adapters SBA-1,** [K2.0001223](#)

\* discontinued items  
only as long as stock is available (single item)

## NATO Rail Sets



**NATO Accessory Rail NRC-5 Set Basic, [KK.0051126](#)**  
includes:  
[K2.0047643](#) 1x NATO Accessory Rail NAR-30  
[K2.0047854](#) 1x NATO Accessory Rail NAR-60  
[K2.0047631](#) 1x NATO Accessory Rail NAR-90  
[K2.0047771](#) 1x NATO Rail Clamp NRC-5



**NATO Accessory Rail NRC-5 Set Pro, [KK.0051127](#)**  
includes:  
[K2.0047643](#) 1x NATO Accessory Rail NAR-30  
[K2.0047854](#) 1x NATO Accessory Rail NAR-60  
[K2.0047631](#) 1x NATO Accessory Rail NAR-90  
[K2.0047771](#) 1x NATO Rail Clamp NRC-5  
[K2.0050106](#) 1x 1/4in Slide for NAR-60/90  
[K2.0050107](#) 1x Double M4 Slide for NAR-60/90



**NATO Accessory Rail NAR-30/NRC-5 Set, [KK.0051123](#)**  
includes:  
[K2.0047643](#) 1x NATO Accessory Rail NAR-30  
[K2.0047771](#) 1x NATO Rail Clamp NRC-5



**NATO Accessory Rail NAR-60/NRC-5 Set, [KK.0051124](#)**  
includes:  
[K2.0047854](#) 1x NATO Accessory Rail NAR-60  
[K2.0047771](#) 1x NATO Rail Clamp NRC-5



**NATO Accessory Rail NAR-90/NRC-5 Set, [KK.0051125](#)**  
includes:  
[K2.0047631](#) 1x NATO Accessory Rail NAR-90  
[K2.0047771](#) 1x NATO Rail Clamp NRC-5







## Articulated Mounting Plate AMP-2 Set

**Articulated Mounting Plate AMP-2 Set, [KK.0053568](#)**, includes:  
[K2.0052697](#) 1x Swivel Mechanism Bracket  
[K2.0051823](#) 1x NATO Rail Bar NRB-160  
K2.0048324 1x NATO Rail Clamp NRC-2



**Radio Interface Adapter RIA-1, AMP-2 Set, [KK.0053569](#)**, includes:  
[K2.0052697](#) 1x Swivel Mechanism Bracket  
[K2.0051823](#) 1x NATO Rail Bar NRB-160  
K2.0048324 1x NATO Rail Clamp NRC-2  
[K2.0036186](#) 1x Radio Interface Adapter RIA-1

## 19 mm Studio Rods

-  **540 mm, [K2.72028.0](#)**  
stainless steel
-  **440 mm, [K2.0001022](#)**  
stainless steel
-  **340 mm, [K2.66269.0](#)**  
stainless steel, lightweight
-  **240 mm, [K2.66270.0](#)**  
stainless steel, lightweight
-  **150 mm, [K2.0016090](#)**  
stainless steel, lightweight
-  **90 mm, [K2.0016088](#)**  
stainless steel, lightweight

**Single Support Rods 540 mm**  
[K2.0014959](#), carbon fibre, black

**Single Support Rods 340 mm**  
[K2.0014954](#), carbon fibre, black

## Components



**NATO Accessory Rail NAR-30**  
[K2.0047643](#)



**NATO Accessory Rail NAR-60**  
[K2.0047854](#)



**NATO Rail Bar NRB-80,**  
[K2.0051779](#)



**NATO Accessory Rail NAR-90**  
[K2.0047631](#)



**NATO Rail Bar NRB-160**  
[K2.0051823](#)



**Swivel Mechanism Bracket**  
[K2.0052697](#)



**3/8in Slide for NAR-60/90**  
[K2.0050105](#)



**1/4in Slide for NAR-60/90**  
[K2.0050106](#)



**Double M4 Slide for NAR-60/90**  
[K2.0050107](#)



**NATO Rail Clamp NRC-1,**  
[K2.0047776](#)



**NATO Rail Clamp NRC-2,**  
K2.0048324



**NATO Rail Clamp NRC-3**  
[K2.0049419](#)



**NATO Rail Clamp NRC-4**  
[K2.0047801](#)



**NATO Rail Clamp NRC-5**  
[K2.0047771](#)



**NATO Rail Clamp NRC-6**  
(Rosette), [K2.0054184](#)

## Accessory Rail System Sets\*\*



**Accessory Rail Cube**  
ARC-1\*\* [K2.0033852](#)



**Accessory Rail Small**  
ARS-1\*\*, [K2.0016751](#)



**Accessory Rail Bracket**  
ARB-1\*\* [K2.0019444](#)



**Accessory Rail Small**  
ARS-2\*\*, [K2.0034009](#)



**Accessory Rail Small**  
ARS-3\*\*, [K2.0034278](#)

\*\* discontinued items  
no stock available anymore

# Rod Standards (blue rods): 15mm LWS (Light Weight Support)

Configuration Overview | 5.7.0 / 2024.01

## Rod Standards

### VIEW INTO LENS FRONT

All dimensions in millimeters

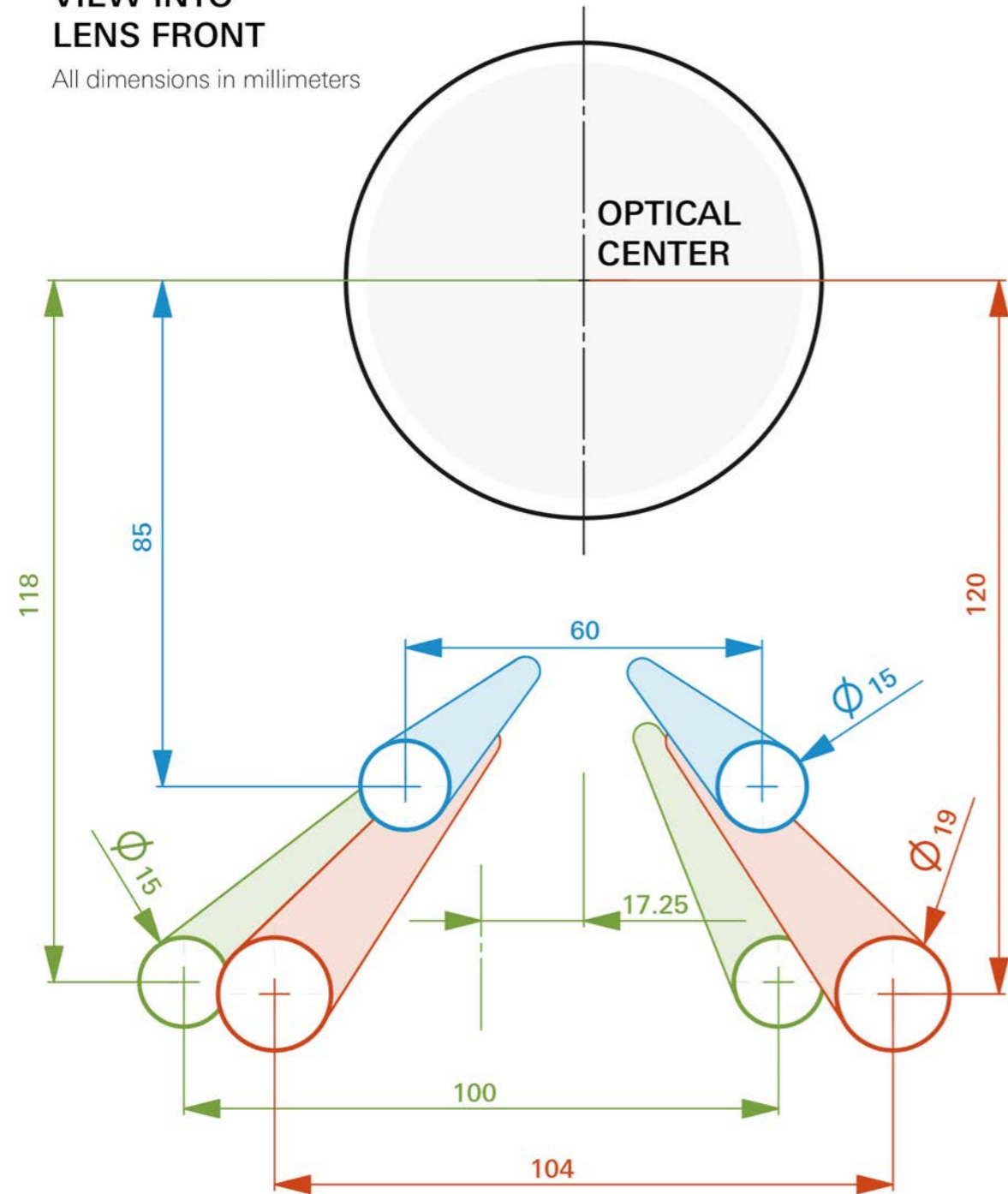

## ALEXA Mini LF / ALEXA Mini



Broadcast Plate for ALEXA Mini, K2.0008509



Mini Adapter Plate MAP-2A, K2.0023839



Camera Shoulder Pad CSP-1, K2.0006807



15mm LWS Adapter for CBP, K2.0019773



Low bracket for CSP-1, K2.0008408



Battery Adapter Plate BAP-1 K2.0006471

## Lens Support



Lightweight Lens Support LLS-1 for 15 mm rods, K2.0017029



LLS-1 Pin, K2.0038782



LLS-1 Lens Bridge, K2.0038783

## AMIRA Camera Support



Universal Adapter Plate UAP-2 Set, K0.0001280



Universal Adapter Plate UAP-2, K2.0001221



Bridge Plate Adapter BPA-3, K2.75006.0 (compatible with BP-8)



Wedge Plate Adapter WPA-1, K2.75000.0

## Matte Boxes



MMB-2



LMB 4x5



SMB-2 Matte Box \*\* 15mm LWS Arm, K2.0002467

\*\* discontinued items no stock available anymore

## Follow Focus



MFF-2



FF-4



FF-5

# Rod Standards (red rods): 19mm Studio Support

Configuration Overview | 5.7.1 / 2021.01

## Rod Standards

### VIEW INTO LENS FRONT

All dimensions in millimeters

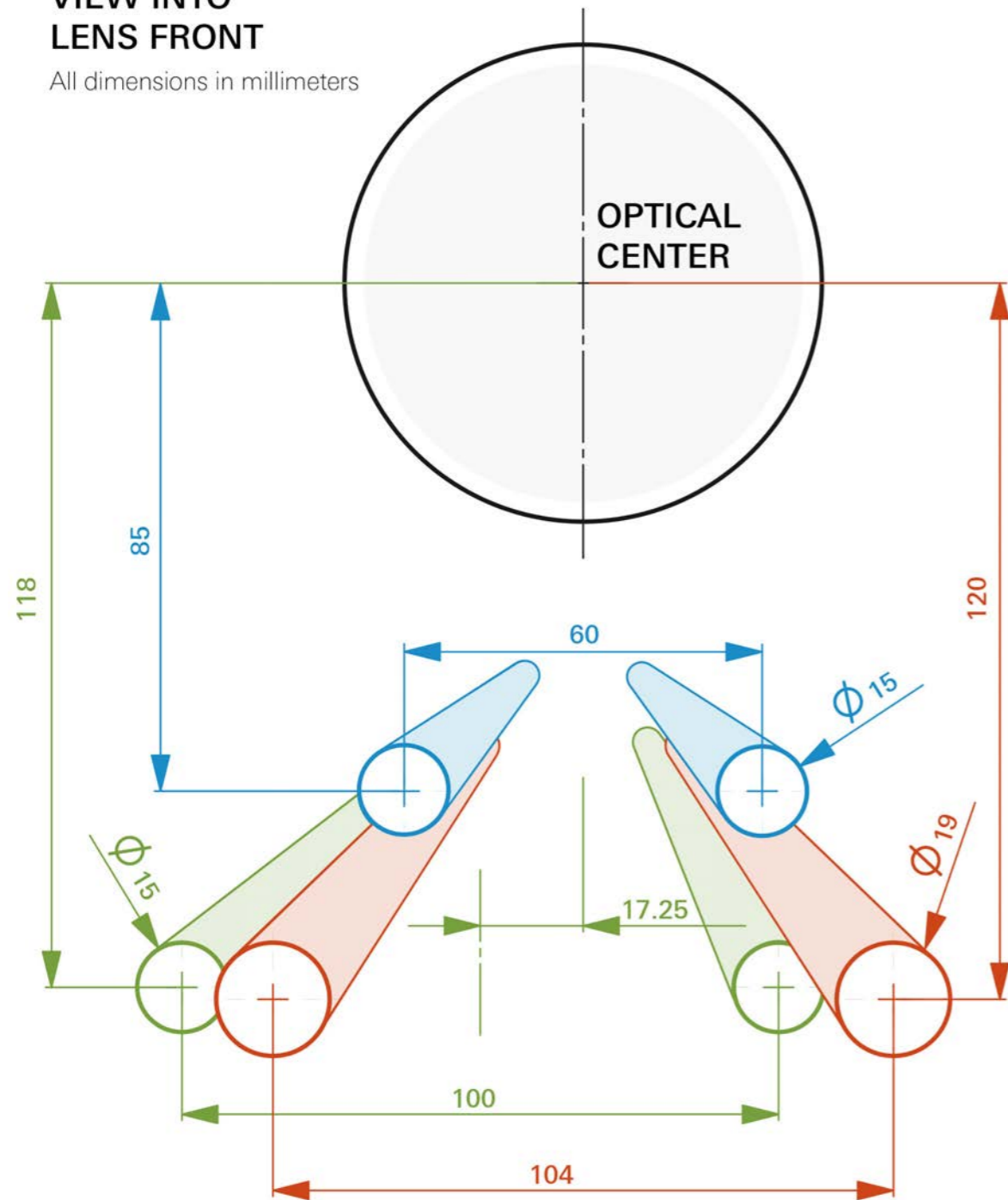

## ALEXA Mini LF / ALEXA Mini



Compact Bridge Plate CBP-1  
19mm for ALEXA Mini  
K2.0014894

## AMIRA Camera Support



Compact Bridge Plate  
CBP-3 19mm for AMIRA,  
K2.0019580

## Bridge Plate Sets

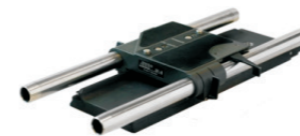

Bridge Plate Set BP-8  
19 mm, K2.47090.0



Bridge Plate Set BP-12  
19 mm, KK.0005819

## Lens Support - Studio



Lens Support LS-9 for 19 mm rods  
K2.47227.0

## Matte Boxes



LMB 4x5 / LMB 6x6  
LMB 19mm Studio  
Rod Adapter  
K2.0013432



SMB-1 / SMB-2  
Matte Box \*\*

\*\* discontinued items  
no stock available  
anymore

## Quick Release HD



19mm Adapter for  
Sony F5/F55, K2.66271.0



Quick Release  
HD Baseplate  
K2.47796.0

Support Rod Holder  
19mm, K2.47798.0

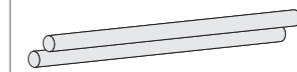

Bridge Plate Sled  
BPS-1, K2.47797.0



Bottom Plates

## Bottom Plates



Bottom Dovetail Plate  
150mm/6in, K2.0020427

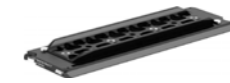

Bottom Dovetail Plate  
300mm/12in, K2.0015896



Bottom Dovetail Plate  
450mm/18in, K2.0015950



Bottom Dovetail Plate  
600mm/24in, K2.0015952



Rod Support Bracket RSB-19, K2.0000440



Bottom Plate Set 600 mm/24"  
incl. RSB-19, KK.0005685

## Follow Focus



FF-4



FF-5

# Rod Standards (green rods): 15mm Studio Support

Configuration Overview | 5.7.2 / 2024.01

## Rod Standards

### VIEW INTO LENS FRONT

All dimensions in millimeters

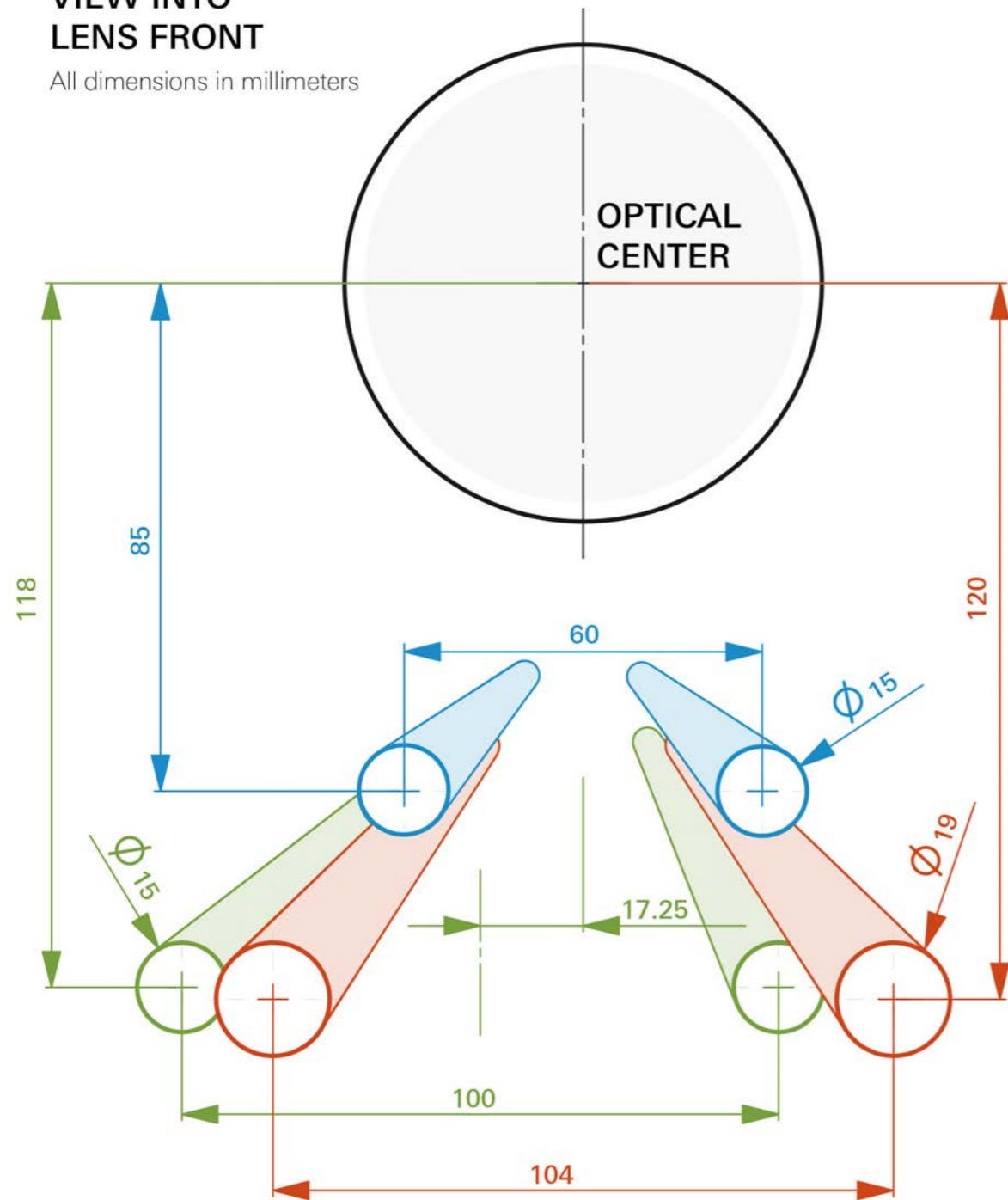

## ALEXA Mini LF / ALEXA Mini



Compact Bridge Plate CBP-2  
15mm for ALEXA Mini,  
K2.0019441

## AMIRA Camera Support



Compact Bridge Plate CBP-4  
15mm for AMIRA, K2.0019582

## Bridge Plate Sets



Bridge Plate Set BP-9  
15 mm, [K2.47091.0](#)



Bridge Plate Set BP-13  
15 mm, KK.0005771

## Lens Support - Studio



Lens Support LS-10 for 15 mm rods  
[K2.47228.0](#)

## Matte Boxes



LMB 4x5 / LMB 6x6



SMB-1 / SMB-2  
Matte Box \*\*

\*\* discontinued items  
no stock available  
anymore

## Quick Release HD

Quick Release  
HD Baseplate  
[K2.47796.0](#)



Bridge Plate Sled  
BPS-1, [K2.47797.0](#)



Support Rod Holder  
15 mm, K2.47799.0

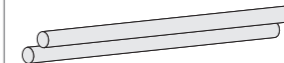

Bottom Plates



## Bottom Plates



Bottom Dovetail Plate  
150mm/6in, [K2.0020427](#)

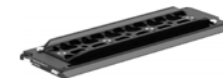

Bottom Dovetail Plate  
300mm/12in, [K2.0015896](#)



Bottom Dovetail Plate  
450mm/18in, [K2.0015950](#)



Bottom Dovetail Plate  
600mm/24in, [K2.0015952](#)



Rod Support Bracket RSB-15  
[K2.0000437](#)



Bottom Plate Set 600 mm/24"  
incl. RSB-15, KK.0005684

## Follow Focus



FF-4



FF-5

## Mini Follow Focus MFF-2 Cine Sets

Cine: Gear Ratio 2:1



### MFF-2 Cine Standard Set

Consists of:  
Mini Follow Focus MFF-2 Cine,  
Focus Knob Standard left,  
Focus Gear 0.8/43 teeth,

[KK.0005759](#)

[K2.65255.0](#)  
[K2.65253.0](#)  
[K2.65259.0](#)



### MFF-2 Cine Hard Stop Set

Consists of:  
Mini Follow Focus MFF-2 Cine,  
Focus Knob Hard Stop,  
Focus Gear 0.8/43 teeth,

[KK.0005760](#)

[K2.65255.0](#)  
[K2.65248.0](#)  
[K2.65259.0](#)



### MFF-2 Cine 2-Speed Set

Consists of:  
Mini Follow Focus MFF-2 Cine,  
Focus Knob 2-Speed,  
Focus gear 0.8/43 teeth,

[KK.0005761](#) \*\*

[K2.65255.0](#)  
[K2.66129.0](#)  
[K2.65259.0](#)



### MFF-2 Cine Standard/Hard Stop Set

Consists of:  
Mini Follow Focus MFF-2 Cine,  
Focus Knob Standard left,  
Focus Knob Hard stop,  
Focus Gear 0.8/43 teeth,

[KK.0005762](#)

[K2.65255.0](#)  
[K2.65253.0](#)  
[K2.65248.0](#)  
[K2.65259.0](#)

## Mini Follow Focus MFF-2 HD Sets

HD: Gear Ratio 1:1



### MFF-2 HD ENG Standard Set

Consists of:  
Mini Follow Focus MFF-2 HD,  
Focus Knob Standard left,  
Focus Gear 0.6/64 teeth,  
Focus Gear 0.5/78 teeth,

[KK.0005772](#)

[K2.65260.0](#)  
[K2.65253.0](#)  
[K2.47632.0](#)  
[K2.47631.0](#)



### MFF-2 HD ENG Hard Stop Set

Consists of:  
Mini Follow Focus MFF-2 HD,  
Focus Knob Hard Stop,  
Focus Gear 0.6/64 teeth,  
Focus Gear 0.5/78 teeth,

[KK.0005773](#) \*\*

[K2.65260.0](#)  
[K2.65248.0](#)  
[K2.47632.0](#)  
[K2.47631.0](#)



### MFF-2 HD SLR Hard Stop Set

Consists of:  
Mini Follow Focus MFF-2 HD,  
Focus Knob Hard Stop,  
Focus gear 0.8/43 teeth,

[KK.0005774](#)

[K2.65260.0](#)  
[K2.65248.0](#)  
[K2.65259.0](#)

## Base and Accessories MFF-2



### MFF-2 Cine, [K2.65255.0](#)

gears and knob need to be ordered separately gear ratio: 1:2

**Flexible Shaft, short**  
[K2.34100.0](#) (300 mm)



### MFF-2 HD, [K2.65260.0](#)

gears and knob need to be ordered separately gear ratio: 1:1



**Flexible Shaft, long**  
[K2.32731.0](#) (900 mm)



**Focus lever**  
[K2.32730.0](#)

## Follow Focus Gears



**Hard Stop Focus Knob for left, [K2.65248.0](#)**  
(incl. 1x [K4.47621.0](#))



**Focus Knob Standard left, [K2.65253.0](#)**  
(incl. 1x [K2.32701.0](#))



**2-Speed Focus Knob left, [K2.66129.0](#)**  
(incl. 1x [K2.32701.0](#))



**Zip Gear cpl., [K2.66131.0](#)**  
incl. zoom or locking pin to equip photo lens with a proper 0,8 gearing zooming or as a support with LS-11 (for 15 mm rods - rods not incl.)

**Zip Gear Basic Set, [KK.0005755](#)**  
consists of 2 zip gears cpl.



**Marking Disk bevelled, [K4.47621.0](#)**  
flat, [K2.47292.0](#)

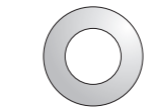

**Marking disk bevelled, [K2.47248.0](#)**  
flat, [K2.32701.0](#)

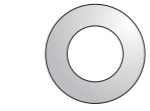

**Marking disk bevelled, [K2.47248.0](#)**  
flat, [K2.32701.0](#)

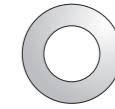

**Set of Marking Disk (10x [K2.32701.0](#)), [KK.0005768](#)**

**Set of Marking Disk (5x [K2.32701.0](#)), [KK.0005769](#)**

## Follow Focus Gears



FF Gear 0.8 Mod, 35 Tooth, 10mm

**Module Gear for smaller prime lenses and 16mm zooms**  
[K2.65276.0](#)



FF Gear 0.8 Mod, 35 Tooth, 25mm

**Gear for lenses with axial movement of focus ring**  
[K2.47557.0](#)



FF Gear 0.8 Mod, 35 Tooth, 45mm

**Gear for prime lenses with large barrels or lenses with extending element when pulling focus, [K2.0020132](#)**



FF Gear 0.8 Mod, 43 Tooth, 45mm

**Gear for zoom lenses with large barrels or lenses with extending element when pulling focus, [K2.0020752](#)**



FF Gear 0.8 Mod, 43 Tooth, 6mm

**Module Gear for larger prime lenses and 35mm zooms**  
[K2.65259.0](#)



FF Gear 32 Dp. 14,5 PA, 35 Tooth, 10mm

**Module Gear for Panavision lenses**  
[K2.66055.0](#)



FF Gear 0.5 Mod, 78 Tooth, 6mm, ENG/EFP

**Focus Gear 0.5 Module for Canon ENG/EFP lenses**  
[K2.47631.0](#)



FF Gear 0.5 Mod, 78 Tooth, 10mm, ENG

**Module Gear - wide face for Canon and Angenieux ENG lenses, [K2.65124.0](#)**



FF Gear 0.6 Mod, 64 Tooth, 6mm, ENG/EFP

**Focus Gear 0.6 Module for Fujinon ENG/EFP lenses**  
[K2.47632.0](#)



FF Gear 0.6 Mod, 64 Tooth, 10mm, ENG

**Module Gear - wide face for Fujinon ENG lenses**  
[K2.65125.0](#)



FF Gear 0.8 Mod, 64 Tooth, 6mm

**Gear for larger prime lenses or for higher transmission ratio on FF5 HD with larger lenses, [K2.65102.0](#)**



Friction gear

\*\* discontinued items  
no stock available anymore

# Studio Follow Focus FF-5 System / FF-4



Configuration Overview | 6.2.0 / 2026.02

## Follow Focus FF-5 Sets



**FF-5 Cine Set basic**  
[KK.0005757](#)  
 Gear Ratio 2:1  
 incl.  
 FF-5 Cine Base, [K2.65246.0](#)  
 Focus Knob standard left, [K2.65253.0](#)  
 Module gear for smaller primes 0,8, [K2.47252.0](#)  
 Module gear for larger primes 0,8, [K2.65259.0](#)

**FF-5 HD Set basic \*\***  
[K0.60145.0](#)  
 Gear Ratio 1:1  
 incl.  
 FF-5 HD Base, [K2.65252.0](#)  
 Focus Knob standard left, [K2.65253.0](#)  
 Module gear 0,5/78/6, [K2.47631.0](#)  
 Module gear 0,6/64/6, [K2.47632.0](#)

additional accessories e.g.  
 Bridgeplate Adapters for  
 19mm or 15mm have to  
 be ordered separately

**\*\* discontinued items  
 no stock available anymore**

**FF-5 Cine Set pro**  
[KK.0005758](#)  
 Gear Ratio 2:1  
 incl.  
 FF-5 Cine Base, [K2.65246.0](#)  
 Focus Knob standard left, [K2.65253.0](#)  
 Module gear for smaller primes 0,8, [K2.47252.0](#)  
 Module gear for larger primes 0,8, [K2.65259.0](#)  
 Focus knob standard right, [K2.47215.0](#)  
 Focus lever, [K2.32730.0](#)  
 Flexible shaft short, [K2.34100.0](#)  
 Marking disk flat large (10x), [K2.32701.0](#)

**FF-5 HD Set pro \*\***  
[K0.60146.0](#)  
 Gear Ratio 1:1  
 incl.  
 FF-5 HD Base, [K2.65252.0](#)  
 Focus Knob standard left, [K2.65253.0](#)  
 Module gear 0,5/78/6, [K2.47631.0](#)  
 Module gear 0,6/64/6, [K2.47632.0](#)  
 Focus knob standard right, [K2.47215.0](#)  
 Focus lever, [K2.32730.0](#)  
 Flexible shaft short, [K2.34100.0](#)  
 Marking disk flat large (10x), [K2.32701.0](#)

## Follow Focus FF-4 black edition

**BLACK edition:**  
**Follow Focus FF-4 SET for 19 mm Rods** [KK.0005745](#)  
**Follow Focus FF-4 SET for 15 mm Rods** [KK.0005746](#)  
 Set includes:  
 Main Unit [K2.65221.0](#), BA Adapter [K2.65224.0](#) (19mm) or  
[K2.47500.0](#) (15mm), Gear for Prime lenses [K2.47252.0](#), Focus  
 lever [K2.32730.0](#), Marking disk (4x) [K2.32701.0](#), case [K2.44965.0](#)

Sample Configuration:

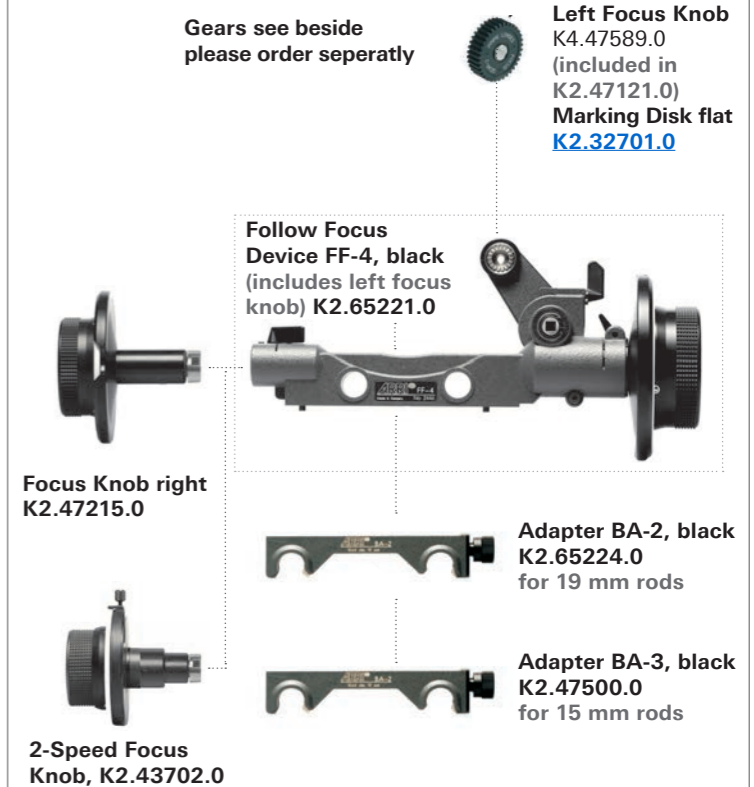

## Basic Units and Accessories FF-5



**FF-5 HD Base \*\***  
[K2.65252.0](#)  
 Gear Ratio 1:1



**FF-5 Cine Base**  
[K2.65246.0](#)  
 Gear Ratio 1:2



**BP Adapter 15 mm**  
[K2.47630.0](#)



**BP Adapter 19 mm**  
[K2.47629.0](#)



**Focus Knob  
 Standard left**  
[K2.65253.0](#)



**Focus Knob  
 Standard right**  
[K2.47215.0](#)



**2-Speed Focus  
 Knob left**  
[K2.66129.0](#)



**2-Speed Focus  
 Knob right**  
[K2.43702.0](#)



**Hard Stop Focus Knob  
 for left and right**  
[K2.65248.0](#)

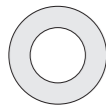

**Marking Disk, flat** [K2.32701.0](#)  
**Marking Disk, bevelled** [K2.47248.0](#)  
 (for standard and 2-speed knob)



**Set of Marking Disk  
 (10x)** [K2.32701.0](#), [KK.0005768](#)  
**Set of Marking Disk  
 (5x)** [K2.32701.0](#), [KK.0005769](#)



**Marking Disk, flat** [K2.47292.0](#)  
**Marking Disk, bevelled** [K4.47621.0](#)  
 (for hard stop knob)



**Flexible Shaft long**  
[K2.32731.0](#)



**Flexible Shaft  
 short,** [K2.34100.0](#)



**Focus Lever**  
[K2.32730.0](#)



**Coupling for  
 Flexible Shaft**  
[K2.47235.0](#)



**Reverse Gear Set**  
[KK.0005770](#)  
 (incl. 1x Reverse Gear  
[K2.65247.0](#) &  
 2x Gear [K2.65259.0](#))



**Extension for  
 Focus Knob**  
[K2.32985.0](#)



**Case for Follow Focus**  
[K2.44965.0](#)

## Follow Focus Gears

For more Gears please see  
 Configuration Overview 7.1.0



## Accessories for FF-4



**Focus Lever**  
[K2.32730.0](#)



**Flexible  
 Shaft, long**  
[K2.32731.0](#)  
 (900 mm)



**Flexible  
 Shaft, short**  
[K2.34100.0](#)  
 (300 mm)



**Extension  
 for focus knob**  
[K2.32985.0](#)



**Coupling  
 for flexible shaft**  
[K2.47235.0](#)  
 (not for LFF-1)



**Case for Follow Focus**  
 FF-3/FF-4, [K2.44965.0](#)



**Marking Disk, bevelled**  
[K2.47248.0](#) (for FF-3, FF-  
 4, FF-5HD and LFF-1  
 with large focus knob only)

**Marking Disk, flat**  
[K2.32701.0](#) (for FF-3, FF-  
 4, FF-5HD and LFF-1  
 with large focus knob only)

**Set of Marking Disk (10x)** [K2.32701.0](#)  
[KK.0005768](#)  
**Set of Marking Disk (5x)** [K2.32701.0](#)  
[KK.0005769](#)

# Mini Matte Box MMB-2 (4" x 5.65")



## Configuration Overview | 7.1.0 / 2026.02

### MMB-2 Sets



**MMB-2 Double 4"x5.65"  
114 Clamp-On Set, [KK.0005764](#)**  
incl.  
MMB-2 basic double 4"x5.65", [K2.66169.0](#)  
Combo 4" x 4"/4" x 5.65" Filter Frame,  
K2.0021499



**MMB-2 Double 4"x5.65" LWS Set  
[KK.0005763](#)**

incl.  
MB-2 basic double 4"x5.65", [K2.66169.0](#)  
2x Combo 4" x 4"/4" x 5.65" Filter Frame,  
K2.0021499  
Console MMB-2, [K2.66127.0](#)  
Top Flag, K2.66093.0



**MMB-2 114 Clamp-On Set  
[KK.0005749](#)**

incl.  
MMB-2 basic module, [K2.66124.0](#)  
Filter frame 4x4/4.5" round, [K2.66128.0](#)  
Combo 4" x 4"/4" x 5.65" Filter Frame,  
K2.0021499



**MMB-2 Basic LWS Set  
[KK.0005750](#)**

incl.  
MMB-2 basic module, [K2.66124.0](#)  
Filter frame 4x4/4.5" round, [K2.66128.0](#)  
Combo 4" x 4"/4" x 5.65" Filter Frame,  
K2.0021499  
Console MMB-2, [K2.66127.0](#)  
Top Flag, K2.66093.0



### MMB-2 Filter Frames



**4" x 4" / 4.5" Filter Frame round  
[K2.66128.0](#)**



**Combo 4" x 4"/4" x 5.65" Filter Frame,  
K2.0021499**

### MMB-2 Basic Module



**MMB-2 Basic Module  
double 4"x5.65"  
[K2.66169.0](#)**  
(filter frame not incl.)



**MMB-2 Basic Module  
[K2.66124.0](#)**  
(filter frame not incl.)



**MMB-2 Console  
[K2.66127.0](#)**

### Flags

**Sideflag full Set  
MMB-2  
[KK.0005747](#)**

incl.  
Side flag holder MMB-2, K2.66134.0 (2x)  
Side flag MMB-2 right, K2.66148.0  
Side flag MMB-2 left, K2.66150.0

**Sideflag Set  
MMB-2  
KK.0005748**

incl.  
Side flag MMB-2 right, K2.66148.0  
Side flag MMB-2 left, K2.66150.0



**Sideflag left  
K2.66150.0**



**Sideflag right  
K2.66148.0**



**Sideflag Holder  
K2.66134.0**

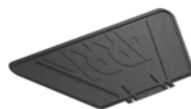

**Topflag  
K2.66093.0**

### MMB-2 Accessories

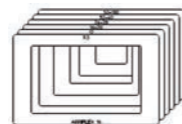

**Mattes-Set for MMB-2  
[K2.66159.0](#)**



**Hand Grip Set (pair)  
[K2.66135.0](#) \***



**Viewfinder Adapter  
[K2.66158.0](#) \***  
has one 1/4" and one  
3/8" thread incl.

### MMB-2 Rings



**Flexible Light Protection,  
[K2.66161.0](#)  
for moving zoom lenses**



**Connection Ring flexible**

connection ring 52, [K2.66156.0](#)  
connection ring 58, [K2.66157.0](#)  
connection ring 62, [K2.66154.0](#)  
connection ring 67, [K2.66152.0](#) \*  
connection ring 72, [K2.66153.0](#)  
connection ring 77, [K2.66151.0](#)  
connection ring 82, [K2.66155.0](#)

**Light Protection Ring Set Pro  
[KK.0005754](#)** (incl. all 7 rings & flexible light protection)

**Light Protection Ring Set Basic  
[KK.0005753](#)** (incl. 3 rings 72, 77, 82 mm & flexible light protection)



**Reduction / Clamp-On Ring**

clamp-on ring 110 mm, [K2.66149.0](#)  
clamp-on ring 104 mm, [K2.66146.0](#)  
clamp-on ring 95 mm, [K2.66147.0](#)  
clamp-on ring 87 mm, [K2.66190.0](#)  
clamp-on ring 85 mm, [K2.0019466](#) \*  
clamp-on ring 80 mm, [K2.66160.0](#)

**Clamp-On Ring Set Cine  
[KK.0005785](#)**

(incl. all 5 still clamp on rings,  
except 114-95)



**Still Lens Clamp-On Ring**

clamp-on ring 52, [K2.66140.0](#)  
clamp-on ring 58, [K2.66143.0](#)  
clamp-on ring 62, [K2.66138.0](#)  
clamp-on ring 67, [K2.66126.0](#)  
clamp-on ring 72, [K2.66137.0](#)  
clamp-on ring 77, [K2.66136.0](#)  
clamp-on ring 82, [K2.66139.0](#)

**Still Lens Clamp-On Set Pro  
[KK.0005751](#)**

(incl. all 7 still clamp on rings)

**Still Lens Clamp-On Set Basic  
[KK.0005752](#)**

(incl. 3 still clamp on rings 72, 77, 82 mm)

\* discontinued items  
only as long as stock is available (single item)

### Matte Box Checker

Find out which matte box you can use with which ARRI lens to avoid vignetting

### MMB-2 System



## Sets for LMB 6x6

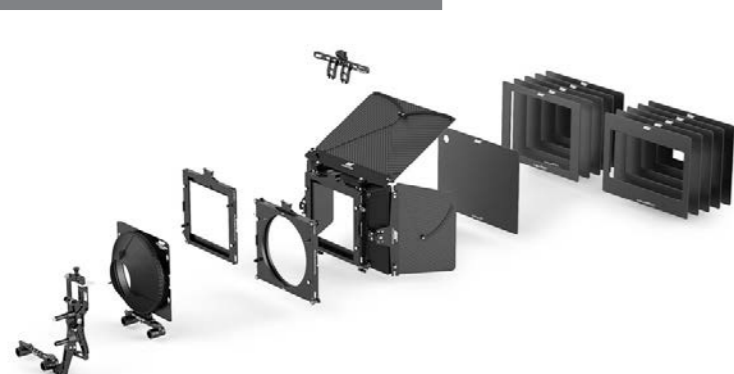

### LMB 6x6 Pro 15mm Studio Set

- [KK.0020235](#) - includes:  
[K2.0019218](#) 1x LMB 6x6 Basic Module  
[K2.0019895](#) 1x LMB 6x6 Swing Away Tilt Mod. 15mm Studio  
[K2.0013440](#) 1x LMB 15mm Studio Rod Adapter  
[K2.0019085](#) 1x LMB 6x6 Tilt and Flex Adapter 80-156mm  
[K2.0019159](#) 1x LMB 6x6 Extra Rotatable Filter Stage  
[K2.0019133](#) 1x LMB 6x6 Extra Non-Rotatable Filter Stage  
[K2.0019178](#) 1x LMB 6x6 Top, Bottom Flag  
[K2.0019216](#) 1x LMB 6x6 Side Flags  
[K2.0013825](#) 2x LMB Flag Holders  
[K2.0013014](#) 1x LMB Accessory Adapter  
[K2.0019253](#) 1x LMB 6x6 Set of Mattes spherical  
[K2.0019258](#) 1x LMB 6x6 Set of Mattes anamorphic

### LMB 6x6 Pro 19mm Studio Set

- [KK.0020233](#) - includes:  
[K2.0019218](#) 1x LMB 6x6 Basic Module  
[K2.0019083](#) 1x LMB 6x6 Swing Away Tilt Mod. 19mm Studio  
[K2.0013432](#) 1x LMB 19mm Studio Rod Adapter  
[K2.0019085](#) 1x LMB 6x6 Tilt and Flex Adapter 80-156mm  
[K2.0019159](#) 1x LMB 6x6 Extra Rotatable Filter Stage  
[K2.0019133](#) 1x LMB 6x6 Extra Non-Rotatable Filter Stage  
[K2.0019178](#) 1x LMB 6x6 Top, Bottom Flag  
[K2.0019216](#) 1x LMB 6x6 Side Flags  
[K2.0013014](#) 1x LMB Accessory Adapter  
[K2.0013825](#) 2x LMB Flag Holders  
[K2.0019253](#) 1x LMB 6x6 Set of Mattes spherical  
[K2.0019258](#) 1x LMB 6x6 Set of Mattes anamorphic

### LMB 6x6 Clamp On 3-Stage Set

- [KK.0020231](#) - includes:  
[K2.0019218](#) 1x LMB 6x6 Basic Module  
[K2.0019133](#) 1x LMB 6x6 Extra Non-Rotatable Filter Stage  
[K2.0019178](#) 1x LMB 6x6 Top, Bottom Flag  
[K2.0023162](#) 1x LMB 6x6 Foam Insert



### LMB 6x6 15mm Studio 3-Stage Set

- [KK.0020232](#) - includes:  
[K2.0019218](#) 1x LMB 6x6 Basic Module  
[K2.0019133](#) 1x LMB 6x6 Extra Non-Rotatable Filter Stage  
[K2.0019178](#) 1x LMB 6x6 Top, Bottom Flag  
[K2.0013440](#) 1x LMB 15mm Studio Rod Adapter  
[K2.0019085](#) 1x LMB 6x6 Tilt and Flex Adapter 80-156mm

### LMB 6x6 19mm Studio 3-Stage Set

- [KK.0020234](#) - includes:  
[K2.0019218](#) 1x LMB 6x6 Basic Module  
[K2.0019133](#) 1x LMB 6x6 Extra Non-Rotatable Filter Stage  
[K2.0019178](#) 1x LMB 6x6 Top, Bottom Flag  
[K2.0013432](#) 1x LMB 19mm Studio Rod Adapter  
[K2.0019085](#) 1x LMB 6x6 Tilt and Flex Adapter 80-156mm

### LMB 6x6 Clamp Adapter Set

- [KK.0020010](#) - includes:  
[K2.0019156](#) 1x LMB 6x6 Clamp Adapter Ø165mm  
[K2.66234.0](#) 1x LMB-6 Clamp Adapter Ø162mm  
[K2.66233.0](#) 1x LMB-6 Clamp Adapter Ø156mm  
[K2.0019275](#) 1x LMB 6x6 Clamp Adapter Ø143mm  
[K2.66235.0](#) 1x LMB-6 Clamp Adapter Ø136mm  
[K2.66236.0](#) 1x LMB-6 Clamp Adapter Ø134mm  
[K2.66237.0](#) 1x LMB-6 Clamp Adapter Ø125mm  
[K2.66238.0](#) 1x LMB-6 Clamp Adapter Ø114mm  
[K2.66239.0](#) 1x LMB-6 Clamp Adapter Ø110mm  
[K2.66240.0](#) 1x LMB-6 Clamp Adapter Ø104mm  
[K2.66241.0](#) 1x LMB-6 Clamp Adapter Ø95mm

### LMB 6x6 Set of Mattes spherical, [K2.0019253](#)



### LMB 6x6 Set of Mattes anamorphic, [K2.0019258](#)



## Clamp Adapter for LMB 6x6

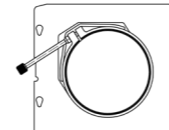

LMB 6x6 Clamp Adapter  
 ø 165mm, [K2.0019156](#)

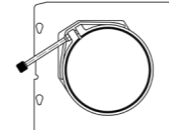

LMB 6x6 Clamp Adapter  
 ø 162 mm, [K2.0019086](#)

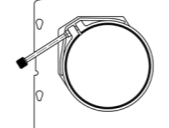

LMB 6x6 Clamp Adapter  
 ø 156 mm, [K2.0019115](#)

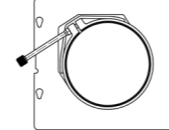

LMB 6x6 Clamp Adapter  
 ø 143 mm, [K2.0019275](#)

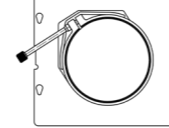

LMB 6x6 Clamp Adapter  
 ø 136 mm, [K2.0019122](#)

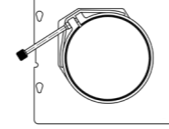

LMB 6x6 Clamp Adapter  
 ø 134 mm, [K2.0019129](#)

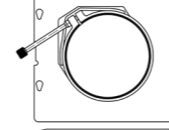

LMB 6x6 Clamp Adapter  
 ø 125 mm, [K2.0019135](#)

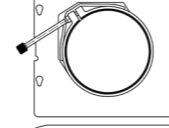

LMB 6x6 Clamp Adapter  
 ø 114 mm, [K2.0019140](#)

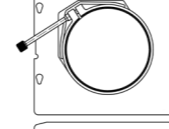

LMB 6x6 Clamp Adapter  
 ø 110 mm, [K2.0019150](#)

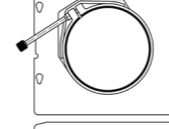

LMB 6x6 Clamp Adapter  
 ø 104 mm, [K2.0019152](#)

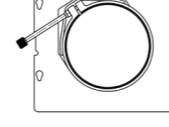

LMB 6x6 Clamp Adapter  
 ø 95 mm, [K2.0019157](#)

**CAUTION: RINGS CAN VIGNETTE.  
 PLEASE CONTACT ARRI.**

## Accessories for LMB 6x6



LMB 6x6 Basic Module  
[K2.0019218](#)



LMB 6x6 Side Flags  
[K2.0019216](#)



LMB 6x6 Top Bottom Flag  
[K2.0019178](#)



Diopter Frame 6"  
[K2.0021310](#)



LMB 6x6 Extra Non-Rotatable Filter Stage  
[K2.0019133](#)

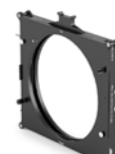

LMB 6x6 Extra Rotatable Filter Stage,  
[K2.0019159](#)



LMB 6x6 Swing way Tilt Module  
 15mm Studio, [K2.0019895](#)  
 19mm Studio, [K2.0019083](#)



LMB 19mm Studio Rod Adapter  
[K2.0013432](#)



LMB 15mm Studio Rod Adapter  
[K2.0013440](#)



Reducer Frame 6.6x6.6 to 4x5.65"  
[K2.66038.0](#)



Filter Frame 6.6" x 6.6"  
[K2.0033481](#)



LMB 6x6 Tilt and Flex Adapter 80-156mm  
[K2.0019085](#)



LMB Flag Holders  
[K2.0013825](#)



LMB Accessory Adapter  
[K2.0013014](#)



LMB 6x6 Foam Insert  
[K2.0023162](#)

## Matte Box Checker

Find out which matte box you can use with which ARRI lens to avoid vignetting

LMB 6x6 technical data:  
 Max number filters: up to three 6.6"x6.6 filters

- LMB 6x6 advanced features:
- For 6.6"x6.6 filter size
  - One product covering a wide range of applications
  - Offers quick and easy set up without tools
  - Lightweight and streamlined

## Sets for LMB 4x5

### LMB 4x5 Pro Set

[KK.0015177](#) - includes:  
 K2.0007992 1x LMB-25 / MB-19 Set of Mattes anam.  
 K2.0000069 1x LMB-25 Set of Mattes  
[K2.0014206](#) 1x LMB 4x5 Tilt and Flex Adapter  
[K2.0013825](#) 2x LMB 4x5 Flag Holders  
[K2.0013750](#) 1x LMB 4x5 Side Flags  
[K2.0013724](#) 1x LMB 4x5 Top Bottom Flag  
[K2.0013447](#) 1x LMB 4x5 Swing Away Tilt Module  
[K2.0014006](#) 1x LMB 4x5 Extra Non-Rotatable Filter Stage  
[K2.0013460](#) 1x LMB 4x5 Extra Rotatable Filter Stage  
[K2.0013014](#) 1x LMB Accessory Adapter  
[K2.0013427](#) 1x LMB 4x5 15 mm LWS Console  
[K2.0013589](#) 1x LMB 4x5 Basic Module (including tray catcher, filter frames and protection matte)  
**Note: Please order Studio Rod Adapters 15mm or 19mm separately**

### LMB 4x5 Clamp-On Set 3-stage

[KK.0015175](#) - includes:  
[K2.0013724](#) 1x LMB 4x5 Top Bottom Flag  
[K2.0014006](#) 1x LMB 4x5 Extra Non-Rotatable Filter Stage  
[K2.0013589](#) 1x LMB 4x5 Basic Module (including tray catcher, filter frames and protection matte)  
**Note: Please order clamp adapters separately**

### LMB 4x5 15mm Lightweight Support (LWS) Set 3-stage

[KK.0015176](#) - includes:  
[K2.0013724](#) 1x LMB 4x5 Top Bottom Flag  
[K2.0014206](#) 1x LMB 4x5 Tilt and Flex Adapter  
[K2.0014006](#) 1x LMB 4x5 Extra Non-Rotatable Filter Stage  
[K2.0013427](#) 1x LMB 4x5 15 mm LWS Console  
[K2.0013589](#) 1x LMB 4x5 Basic Module (including tray catcher, filter frames and protection matte)

### Upgrade Set LMB-25 to LMB 4x5 basic

[KK.0015178](#) - includes:  
 K2.0015140 1x LMB 4x5 Backplate with Filter Guides (including protection matte)  
[K2.0013825](#) 1x LMB 4x5 Flag Holders

### Flexible Sunshade Side Flag Holders Set,

[KK.0038066](#), includes:  
[K2.0033772](#) 1x Flexible Sunshade LMB 4x5  
 K2.0036441 1x LMB Side Flag Holders

### Pro Set Diopter Accessory 138mm/4,5 inch

[KK.0021007](#) - includes:  
[K2.0013740](#) 3x Diopter Frame 138mm  
[K2.0014745](#) 1x Diopter Stage 138mm  
[K2.0014357](#) 1x Diopter Adapter 138mm to 4.5in  
 K2.0020158 3x Pouch Rota Pola 4x5/Diopter Frame 138  
 K2.0020157 1x Pouch Diopter Stage 138

### Upgrade Set LMB-25 to LMB 4x5 Pro

[KK.0015181](#) - includes:  
 K2.0015140 1x LMB 4x5 Backplate wit Filter Guides (including protection matte)  
[K2.0014206](#) 1x LMB 4x5 Tilt and Flex Adapter  
[K2.0013825](#) 1x LMB 4x5 Flag Holders  
[K2.0013750](#) 1x LMB 4x5 Side Flags  
[K2.0013724](#) 2x LMB 4x5 Top Bottom Flag  
[K2.0013447](#) 1x LMB 4x5 Swing Away Tilt Module  
[K2.0014006](#) 1x LMB 4x5 Extra Non-Rotatable Filter Stage  
[K2.0013460](#) 1x LMB 4x5 Rotatable Filter Stage  
[K2.0013014](#) 1x LMB Accessory Adapter  
[K2.0013427](#) 1x LMB 4x5 15 mm LWS Console  
**Note: Please order Studio Rod Adapters 15mm or 19mm separately**

### LMB 4x5 Clamp Adapter Set

[KK.0015133](#) - includes:  
[K2.0014376](#) 1x LMB 4x5 Clamp Adapter Ø 80mm  
[K2.0015065](#) 1x LMB 4x5 Clamp Adapter Ø 85mm  
[K2.0014227](#) 1x LMB 4x5 Clamp Adapter Ø 87mm  
[K2.0014439](#) 1x LMB 4x5 Clamp Adapter Ø 95mm  
[K2.0015103](#) 1x LMB 4x5 Clamp Adapter Ø 100mm  
[K2.0014422](#) 1x LMB 4x5 Clamp Adapter Ø 104mm  
[K2.0014409](#) 1x LMB 4x5 Clamp Adapter Ø 110mm  
[K2.0014396](#) 1x LMB 4x5 Clamp Adapter Ø 114mm  
[K2.0014377](#) 1x LMB 4x5 Clamp Adapter Ø 125mm  
[K2.0014359](#) 1x LMB 4x5 Clamp Adapter Ø 134mm  
[K2.0014348](#) 1x LMB 4x5 Clamp Adapter Ø 136mm  
[K2.0014168](#) 1x LMB 4x5 Clamp Adapter Ø 143mm  
 (interface for LMB 4x5 15 mm LWS Console  
[K2.0013427](#) integrated)  
[K2.0015075](#) 1x LMB 4x5 Clamp Adapter Ø 162mm

for more Clamp Adapter Sets please see website, price list or contact your dealer

## Clamp Adapter for LMB 4x5

CAUTION: Clamp-Adapter CAN VIGNETTE.

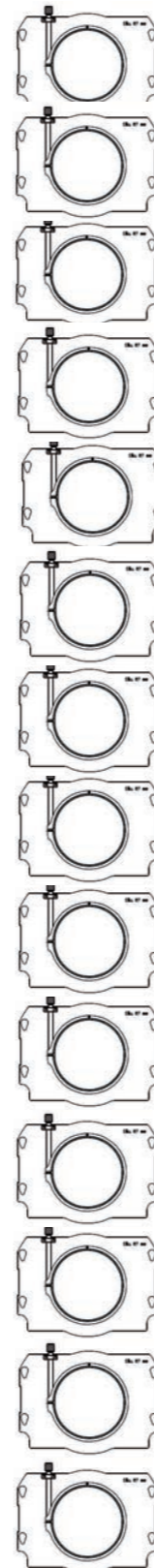

LMB 4x5 Clamp Adapter  
 ø 162mm, [K2.0015075](#)

LMB 4x5 Clamp Adapter  
 ø 156mm, [K2.0039254](#)

LMB 4x5 Clamp Adapter  
 ø 143mm, [K2.0014168](#)

LMB 4x5 Clamp Adapter  
 ø 136mm, [K2.0014348](#)

LMB 4x5 Clamp Adapter  
 ø 134mm, [K2.0014359](#)

LMB 4x5 Clamp Adapter  
 ø 125mm, [K2.0014377](#)

LMB 4x5 Clamp Adapter  
 ø 114mm, [K2.0014396](#)

LMB 4x5 Clamp Adapter  
 ø 110mm, [K2.0014409](#)

LMB 4x5 Clamp Adapter  
 ø 104mm, [K2.0014422](#)

LMB 4x5 Clamp Adapter  
 ø 100mm, [K2.0015103](#)

LMB 4x5 Clamp Adapter  
 ø 95mm, [K2.0014439](#)

LMB 4x5 Clamp Adapter  
 ø 87mm, [K2.0014227](#)

LMB 4x5 Clamp Adapter  
 ø 85mm, [K2.0015065](#)

LMB 4x5 Clamp Adapter  
 ø 80mm, [K2.0014376](#)

## Accessories for LMB 4x5



LMB 4x5 Basic Module, [K2.0013589](#)

Flexible Sunshade LMB 4x5, [K2.0033772](#)

LMB 4x5 Side Flags, [K2.0013750](#)

LMB 4x5 Top Bottom Flag, [K2.0013724](#)



LMB 4x5 Extra Non-Rotatable Filter Stage [K2.0014006](#)

LMB 4x5 Rotatable Filter Stage, [K2.0013460](#)

LMB 4x5 Swing Away Tilt Module [K2.0013447](#)

Filter Frame 4"x 4" [K2.0015551](#)



LMB 4x5 19 mm Studio Rod Adapter [K2.0013432](#)

LMB 4x5 15 mm Studio Rod Adapter [K2.0013440](#)

LMB 4x5 15 mm LWS Console [K2.0013427](#)

LMB 4x5 Tilt and Flex Adapter [K2.0014206](#)



Diopter Frame 138 mm [K2.0013740](#)

Diopter Adapter 138 mm to 4.5" [K2.0014357](#)

Diopter Stage 138mm [K2.0014745](#)

Rota Pola Frame [K2.0009434](#)



LMB 4x5 Foam Insert [K2.0023149](#)

LMB 4x5 Flag Holders [K2.0013825](#)

3/8" Accessory Shoe [K2.66178.0](#)

LMB Accessory Adapter [K2.0013014](#)

## Matte Box Checker

Find out which matte box you can use with which ARRI lens to avoid vignetting

### LMB 4x5 technical data:

Max number filters: up to three 4"x5.65" or 4"x4" filters

### LMB 4x5 advanced features:

- One product covering a wide range of applications
- Clamp-on, 15mm lightweight and 15 and 19mm Studio Rod Support Options
- Offers quick and easy set up without tools
- Tilting option
- Safety gear such as a tray catcher and securing loop
- Accessory mount for ultrasonic or other devices
- Removable sunshade with captive screws

# Accessories for LMB 6x6 & LMB 4x5



Configuration Overview | 7.3.1 / 2024.11

## Accessories for LMB 6x6



LMB 6x6 Basic Module  
[K2.0019218](#)



LMB 6x6 Swing way Tilt Module  
15mm Studio, [K2.0019895](#)  
19mm Studio, [K2.0019083](#)



LMB 6x6 Tilt and Flex Adapter 80-156mm,  
[K2.0019085](#)



LMB 6x6 Side Flags  
[K2.0019216](#)



LMB 6x6 Top Bottom Flag  
[K2.0019178](#)



Diopter Frame 6"  
[K2.0021310](#)



Diopter Stage 6"  
[K2.0021332](#)



Diopter Adapter 6" to 138mm  
[K2.0021298](#)



LMB 6x6 Extra Non-Rotatable Filter Stage,  
[K2.0019133](#)



LMB 6x6 Extra Rotatable Filter Stage,  
[K2.0019159](#)



Reducer Frame 6.6X6.6 to 4x5.65",  
[K2.66038.0](#)



Filter Frame 6.6"x 6.6"  
[K2.0033481](#)



LMB 6x6 Set of Mattes spherical,  
[K2.0019253](#)



LMB 6x6 Set of Mattes anamorphic,  
[K2.0019258](#)



LMB 6x6 Foam Insert  
[K2.0023162](#)

## Accessories for LMB 4x5



LMB 4x5 Basic Module  
[K2.0013589](#)



LMB 4x5 Swing Away Tilt Module  
[K2.0013447](#)



LMB 4x5 15 mm LWS Console  
[K2.0013427](#)



LMB 4x5 Side Flags  
[K2.0013750](#)

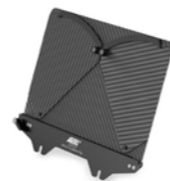

LMB 4x5 Top Bottom Flag,  
[K2.0013724](#)



LMB 4x5 Tilt and Flex Adapter,  
[K2.0014206](#)



Diopter Frame 138 mm,  
[K2.0013740](#)



Diopter Adapter 138 mm to 4.5"  
[K2.0014357](#)



Diopter Stage 138mm  
[K2.0014745](#)



LMB 4x5 Extra Non-Rotatable Filter Stage  
[K2.0014006](#)



LMB 4x5 Rotatable Filter Stage,  
[K2.0013460](#)

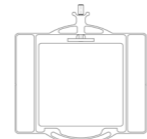

Filter Frame 4"x 4"  
[K2.0015551](#)



Rota Pola Frame  
[K2.0009434](#)

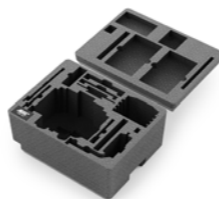

LMB 4x5 Foam Insert  
[K2.0023149](#)



Flexible Sunshade Side Flag Holders Set,  
[KK.0038066](#), includes:  
[K2.0033772](#) 1x Flexible Sunshade LMB 4x5  
[K2.0036441](#) 1x LMB Side Flag Holders

## Accessories for LMB 6x6 & LMB 4x5



LMB 19mm Studio Rod Adapter  
[K2.0013432](#)



LMB 15mm Studio Rod Adapter  
[K2.0013440](#)



3/8" Accessory Shoe,  
[K2.66178.0](#)



LMB 4x5 Flag Holders  
[K2.0013825](#)



Accessory Rail Cube ARC-1,  
[K2.0033852](#)



LMB Accessory Adapter  
[K2.0013014](#)



LMB 4x5 / LMB-6 Tray Catcher  
[K2.66202.0](#)

## Configuration Overview | 7.8.0 / 2021.01

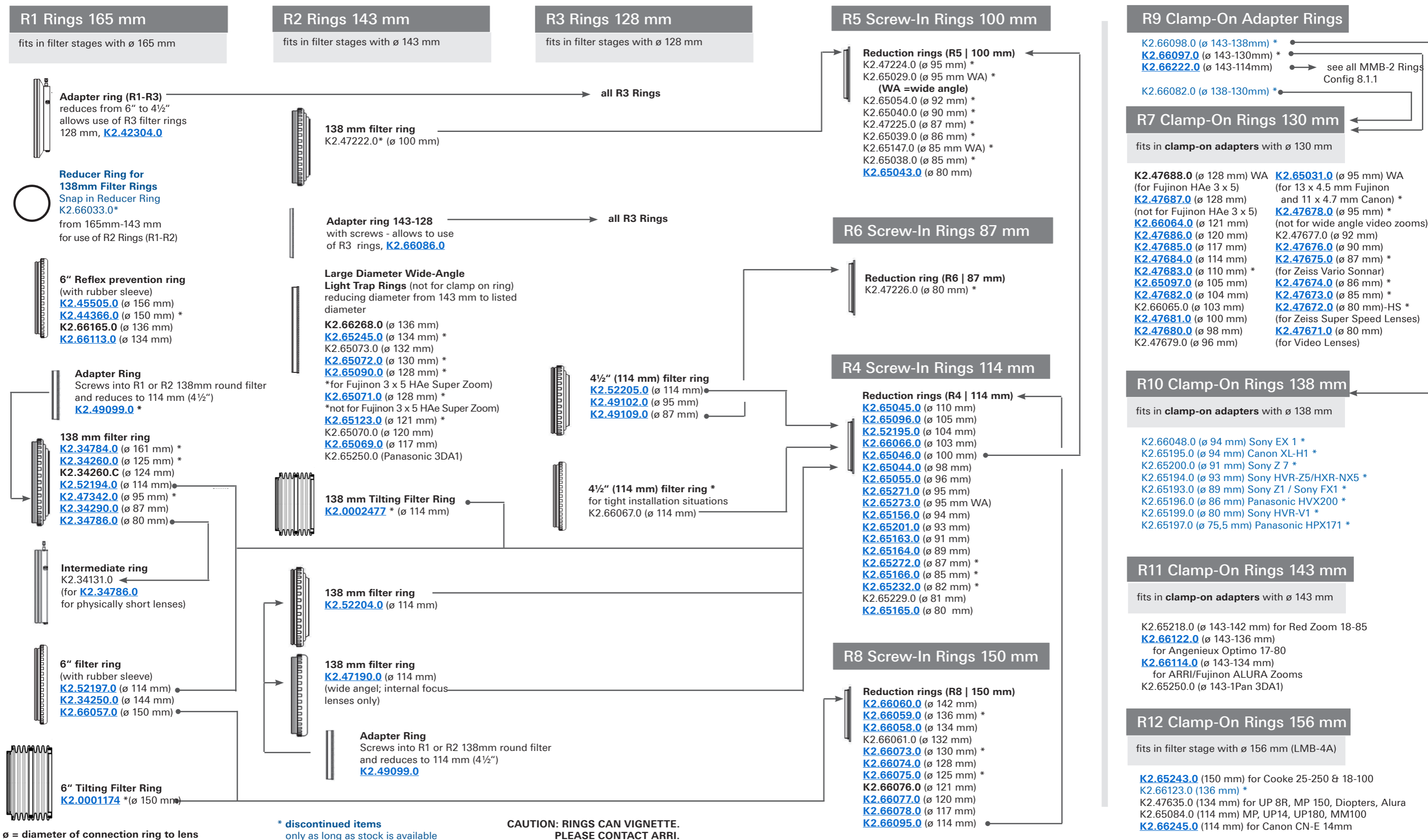

## F1 Filter Frames

use for SMB-1, MB-14, MB-28, LMB-4A, LMB-6, LMB 6x6

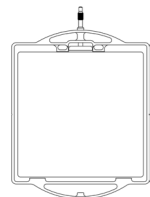

**Anti Reflection Filter Frame 6.6"x6.6"**, non geared, [K2.0008125](#) \*

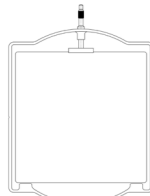

**Triple Filter Frame 6.6"x6.6"**, non geared [K2.0005906](#)

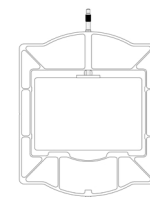

**Filter Frame 4"x5.65"** non geared [K2.0005874](#) \*

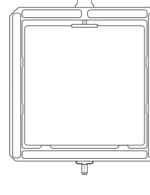

**Filter Frame 5.65"x5.65"** non geared, [K2.66063.0](#)  
to be used with SMB-1/MB-14 / MB-28 Stages

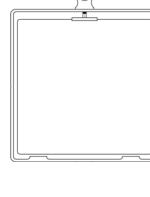

**Filter Frame 6.6"x 6.6"** [K2.0033481](#)

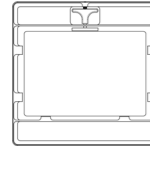

**Reducer Frame from 6.6"x6.6" to 4"x5.65"** for horizontal or vertical use [K2.66038.0](#)

## F2 Filter Frames

use for SMB-2, MB-18

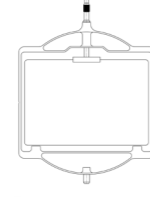

**Triple Filter Frame 4"x5.65"**, non geared [K2.0006085](#) \* only for SMB-2

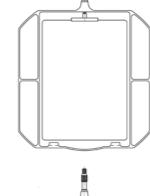

**Filter Frame 4"x5.65"** non geared, vertical [K2.47814.0](#) \*

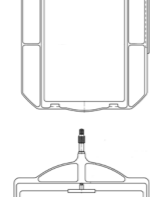

**Filter Frame 4"x5.65"** geared, vertical [K2.47815.0](#) \*

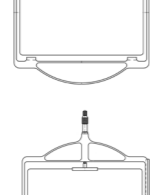

**Filter Frame 4"x5.65"** non geared, horizontal [K2.49083.0](#)

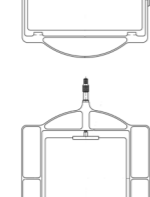

**Filter Frame 4"x5.65"** geared, horizontal [K2.49096.0](#) \*

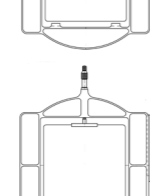

**Filter Frame 4"x4"** non geared [K2.47185.0](#)

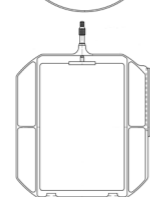

**Filter Frame 4"x4"** geared [K2.47186.0](#)

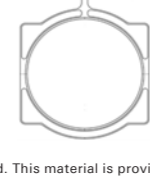

**Filter Frame 4"x6"** geared [K2.49027.0](#)

**Filter Frame round for 138mm** [K2.49023.0](#) \*

## F4 Filter Frames

use for MMB-1, MMB-2, LMB-25, MB-29

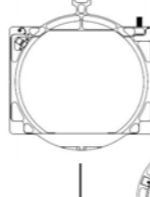

**Diopter Frame 138 mm**, [K2.0013740](#) only compatible with LMB-5,15,25 and 4x5

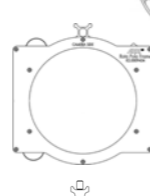

**Diopter Adapter 138 mm to 4.5"** [K2.0014357](#)



**Rota Pola Frame** [K2.0009434](#)

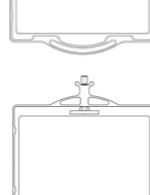

**Anti Reflection Frame ARF-2 for 4"x5.65"**, non geared, [K2.0047475](#) only for LMB-25/LMB 4x5

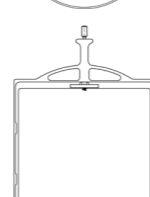

**Filter Frame 4"x5.65"/4"x4"** [K2.0021499](#) (LMB)

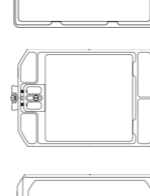

**Filter Frame Combo 4"x5.65"/4"x4"** [K2.66133.0](#)

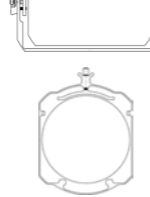

**Filter Frame 5.65"x5.65"** [K2.66036.0](#)



**Filter Frame 4"x4"** for MMB-1 side load, [K2.66072.0](#)

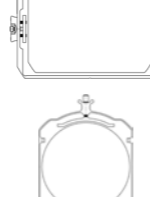

**Filter Frame 4"x5.65" with closed corners** for MMB-1 side load, [K2.66053.0](#)

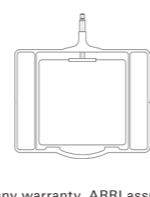

**Filter Frame Combo 4"x4"/4.5" round** for MMB-2 Basic [K2.66128.0](#)

**Filter Frame 4"x4"** [K2.47104.0](#) (phase out)

## F4 Filter Frames

use for MMB-1, MMB-2, LMB-25, MB-29

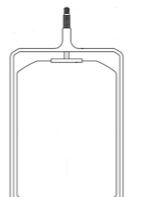

**Filter Frame 4"x5.65"** vertical (for MB-19, MB-29) [K4.47493.0](#) \* [K2.0001035](#) \*

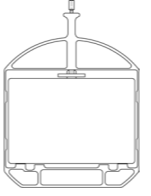

**Filter Frame Combo 4"x5.65"/4"x4"** [K2.65230.0](#)

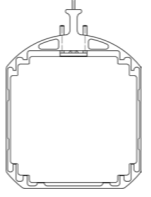

**Filter Frame Combo 4"x5.65"/5"x5"** [K2.66037.0](#) \*

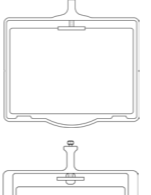

**Filter Frame 4"x5.65"** [K2.47669.0](#)

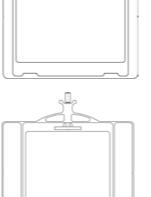

**Filter Frame 5"x5"** [K2.65183.0](#)

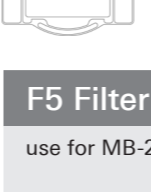

**Filter Frame 4"x 4"** [K2.0015551](#)

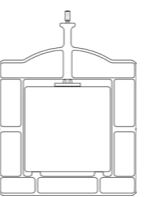

**Filter Frame 4"x4"** [K2.65098.0](#) (phase out)

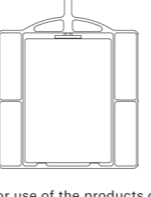

**Filter Frame 4"x5.65"** vertical, [K2.65049.0](#)

## F5 Filter Frames

use for MB-20 / MB-28 Stage K2.66032.0

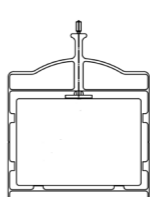

**Filter Frame 4"x5.65"** horizontal, [K2.65048.0](#) \*

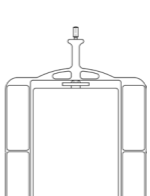

**Filter Frame 4"x6"** vertical, [K2.66023.0](#)

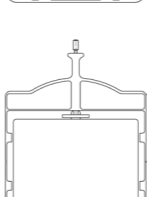

**Filter Frame Combo 4"x5.65"/4"x4"** horizontal, [K2.65095.0](#) \*

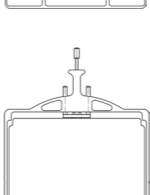

**Filter Frame Combo 5.65"x5.65"/5"x6"** horizontal, [K2.65022.0](#)

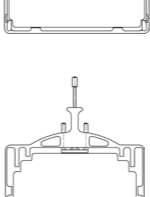

**Filter Frame Combo 4"x5.65"/5"x5"** [K2.65023.0](#) \*

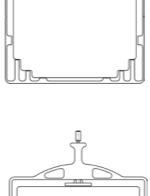

**Filter Frame Combo 5.65"x5.65"/4"x5.65"** vertical, [K2.65148.0](#)

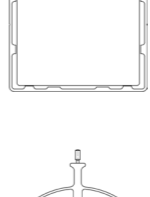

**Filter Frame 4"x5.65"** for 16x9 Wide-Angle [K2.66005.0](#)

## ARRI FSND Filter 6.6" x 6.6"

Pouch included visit website for more details



- ARRI FSND 0.3 Filter 6.6" x 6.6" [K2.0013892](#)
- ARRI FSND 0.6 Filter 6.6" x 6.6" [K2.0013894](#)
- ARRI FSND 0.9 Filter 6.6" x 6.6" [K2.0013896](#)
- ARRI FSND 1.2 Filter 6.6" x 6.6" [K2.0013898](#)
- ARRI FSND 1.5 Filter 6.6" x 6.6" [K2.0013900](#)
- ARRI FSND 1.8 Filter 6.6" x 6.6" [K2.0013902](#)
- ARRI FSND 2.1 Filter 6.6" x 6.6" [K2.0013905](#)
- ARRI FSND 2.4 Filter 6.6" x 6.6" [K2.0013906](#)

## ARRI FSND Filter 4" x 5.65"

Pouch included visit website for more details



- ARRI FSND 0.3 Filter 4" x 5.65" [K2.0013887](#)
- ARRI FSND 0.6 Filter 4" x 5.65" [K2.0013901](#)
- ARRI FSND 0.9 Filter 4" x 5.65" [K2.0013895](#)
- ARRI FSND 1.2 Filter 4" x 5.65" [K2.0013904](#)
- ARRI FSND 1.5 Filter 4" x 5.65" [K2.0013897](#)
- ARRI FSND 1.8 Filter 4" x 5.65" [K2.0013890](#)
- ARRI FSND 2.1 Filter 4" x 5.65" [K2.0013903](#)
- ARRI FSND 2.4 Filter 4" x 5.65" [K2.0013891](#)

\* discontinued items only as long as stock is available

# ARTEMIS & TRINITY - Upgrade Sets Options



Configuration Overview | 8.0.0 / 2024.11

## Upgrade paths for different Systems

Only the following upgrade paths are currently available

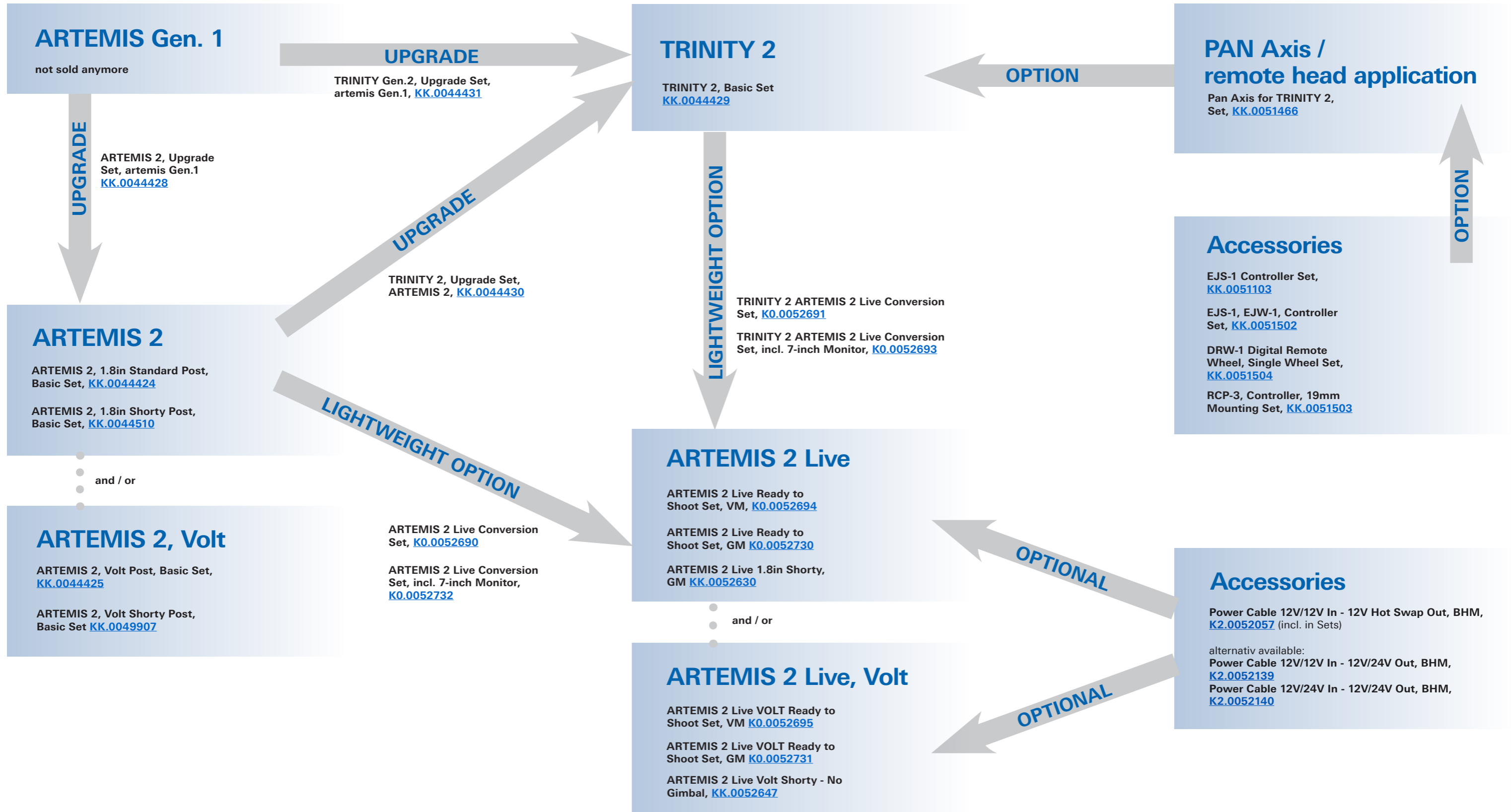

## TRINITY 1 -> TRINITY Live - Upgrade Sets Options

TRINITY 1 to TRINITY 2: no upgrade available

### TRINITY 1

not sold anymore

OPTION

### TRINITY 1, 24V

24V Upgrade for TRINITY Gen. 1, [KK.0024710](#)

#### TRINITY Live Upgrade Set Basic, [KK.0044512](#)

##### Variant 1:

An Owner Operator wants to upgrade his own system to TRINITY Live. In this case, the Owner Operator contacts the ARRI Service in his region. It can then be decided on site whether the conversion will be carried out locally or at ARRI Service in Munich. The conversion takes two days, including all necessary tests and, if necessary, additional time for shipping.

##### Variant 2:

An operator who wanted to buy a TRINITY Live was offered a used TRINITY Gen. 1 by another owner. In this case, ARRI Service offers you a pre-check for the device to be sold. This way, the new customer can be sure that the purchase of the used system is worthwhile and that the conversion to TRINITY Live is feasible. Tools and the necessary training are available to the service staff in the regions from Q1 2024 for this pre-check. **Plus possible costs for other necessary ARRI services.**

#### 24V Upgrade for TRINITY Live (Gen.1), [KK.0050214](#)

Variant 1 and 2 plus possible costs for other necessary ARRI services.

This 24 V upgrade for TRINITY Live allows the system to provide reliable 24 V camera power when operators need to fly an ALEXA Mini LF, ALEXA 35, or Sony Venice. TRINITY Gen.1 rigs previously upgraded to 24 V must still be fitted with this new 24 V upgrade

#### Master Grip TRINITY 1 Pro Set, [KK.0049712](#)

If this function is to be part of a TRINITY Live upgrade, it must be ordered at the same time as the actual upgrade. This is the only way to avoid unnecessary costs.

This upgrade gives operators simultaneous control of a zoom lens and the stabilizer's tilt axis via a common LBUS controller. The Zoom will be controlled by the LCUBE CUB-2 or by a c-force mini motor.

### Required Accessory Sets

#### Tally Set for TRINITY Gen.1, 3pin Lemo, [KK.0044682](#)

The TALLY Gen.2 is required to integrate the TRINITY Live into any Multicam application.

#### CCP Live Camera Control Panel Live Set, [KK.0047755](#)

The CCP Live is based on the CCP-1 and has been expanded to include an HDMI down converter, an HD SDI video out socket and a Tally out socket. This allows the operator to get a direct monitor video feed from the camera even when both video outputs are used for 2 x 6G video. The additional 1080 HD SDI video signal allows a control monitor to be connected to the camera if both video out sockets are already in use. If the camera is integrated into a multi-cam setup, the Tally Gen. 2 system can be controlled via the Tally Out socket.

### TRINITY Live

sold only via CPO

UPGRADE via Service

## Stabilized Remote Head - Upgrade Sets Options

Only the following upgrade paths are currently available

### SRH-360

not sold anymore

360 EVO Upgrade for SRH-360, [KK.0050638](#)

UPGRADE

### EVO-360

360 EVO Basic Set, No Joystick [KK.0050103](#)

### SRH-3

not sold anymore

360 EVO Upgrade for SRH-3, [KK.0050639](#)

UPGRADE

## ARTEMIS 2 Overview



**Gimbal Handle Extender for 1.8in Gimbal, [K2.0010569](#)**

↓

**ARTEMIS Gimbal, Ø1.8in, [K2.0010493](#)**

**ARTEMIS Carbon Center Post, Ø1.8in, [K2.0010489](#)**

**ARTEMIS Carbon Center Post, Ø1.8in, Short, No Main Cable, [K2.0041474](#)**

**ARTEMIS Super Post, Gen.2, 1.8in, 3B, 16-pin, [KK.0041404](#)**

**Carbon Center Post, Volt Gimbal, Pro Set, [K0.0048623](#)**

**ARTEMIS 2, Volt Shorty Post, Basic Set, [KK.0049907](#)**



**ARTEMIS Post Extension, 1.8in, 3B, length 8.5in, 16-pin, [K2.0041976](#)**

**Battery Mounting Base & different versions of battery mounts please see also Config 8.3.0**

**Hinge for Battery Hanger Module, Gen.2, Ø19mm, [K2.0037757](#)**



**SET: Battery Hanger Gen. 2, incl. Ø19mm Rods, [K0.0044360](#)**

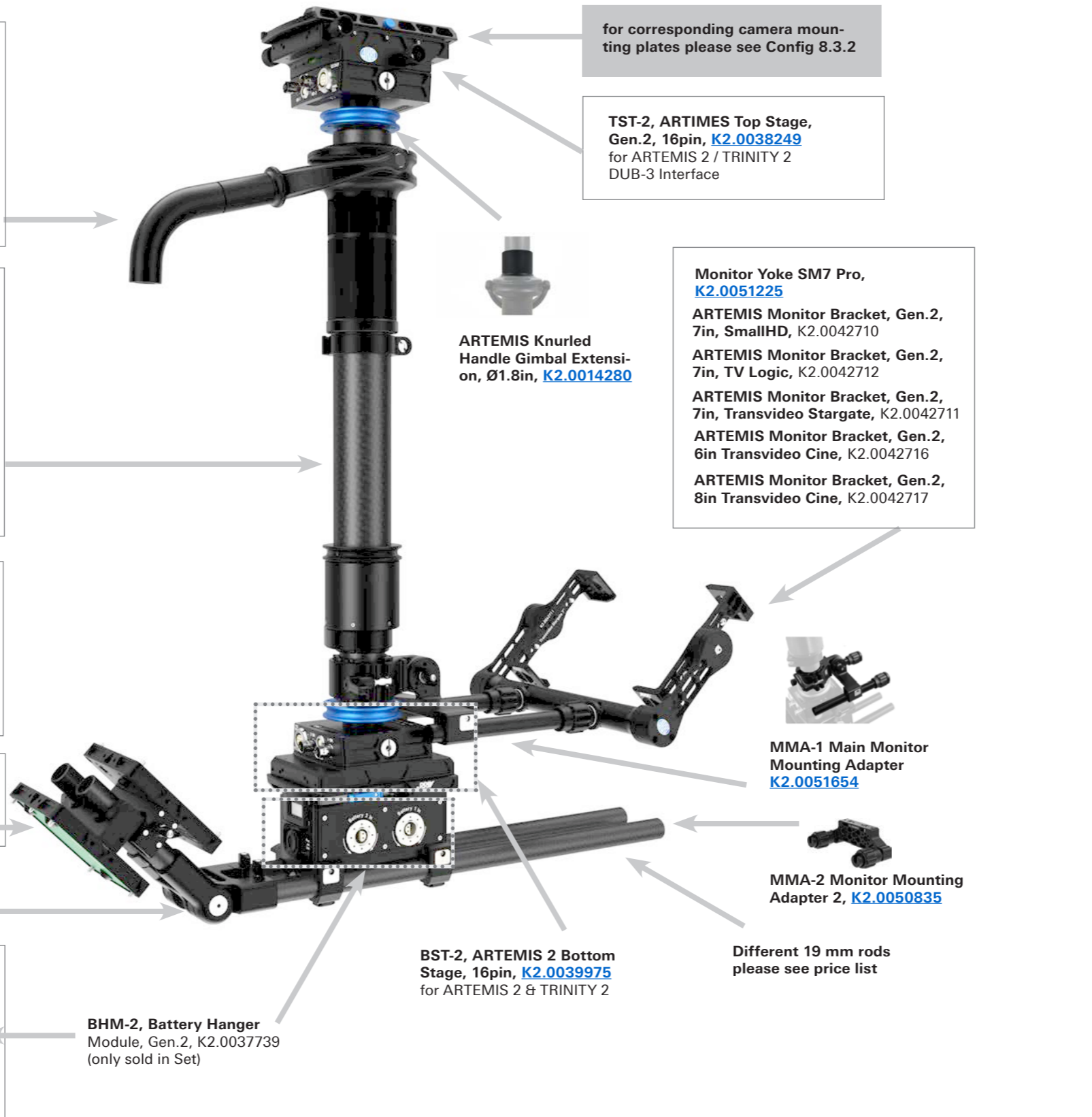

## ARTEMIS Arm Sets and Vest



**SmartSystem ArmX1, [K2.0054618](#) For TRINITY 2, ARTEMIS, 2 Artemis 2 Live**

**SmartSystem ArmX1Lite +, [K2.0054619](#) For Artemis 2 Live**



**ARTEMIS Carbon Spring Arm, 23kg/50.7lb, Pro Set, range of payload 19-23 kg, [KK.0020297](#)**  
 Consists of:  
 ARTEMIS Carbon Spring Arm, 23kg/50.7lb [K2.0010331](#)  
 6 mm Hex Key 1/4" [K2.0010435](#)  
 4 mm Hex Key / 5/32" [K2.0010434](#)  
 Arm Soft Bag [K2.0010463](#)

**ARTEMIS Carbon Spring Arm, 19kg/41.8lb, Pro Set, range of payload 15-19 kg, [KK.0020296](#) \***

**ARTEMIS Carbon Spring Arm, 26kg/57.3lb, Pro Set, range of payload 23-26 kg, [KK.0020298](#) \***

**ARTEMIS Carbon Spring Arm, 30kg/66.1lb, Pro Set, range of payload 26-30 kg, [KK.0039452](#) \***



**Rain Cover Spring Arm, [K2.0010465](#)**



**ARTEMIS Vest, [K2.0010333](#)**

**\* discontinued - only as long as stock is available**

## ARTEMIS 2 - Basic Sets



### ARTEMIS 2, 1.8" Standard Post, Basic Set, [KK.0044424](#)

Key features  
 Payload up to 40 Kg/88 lb  
 12V & 24V high-capacity system and camera power supply  
 LBUS, CAN Bus, tally through  
 2 x 12G video  
 1.8in telescopic center post with fine trim length adjustment  
 1.8in super-low friction gimbal  
 Regulated high-capacity battery management  
 Interchangeable BMS-2 battery mounts  
 Battery communication

includes:  
[K2.0041201](#) 1x Stabilizer Adapter Mount SAM-Zero  
[K2.0039443](#) 1x Cam Pwr Gen.2, ALEXA 35, Mini, AMIRA, 24 V, 8-pin  
[K2.0039448](#) 1x Cam Pwr Gen.2, 4-pin XLR, 12 V  
[K2.0041984](#) 1x 12G HD SDI BNC Cable, 0,63m/25in  
[K2.0010319](#) 1x ARTEMIS Docking Bracket, 1.8in  
[K2.0040046](#) 1x CSS Post Tool for ARTEMIS and TRINITY  
[K2.0010493](#) 1x ARTEMIS Gimbal, Ø1.8in  
[K2.0038249](#) 1x TST-2, ARTEMIS Top Stage, Gen. 2, 16 pin  
[K2.0010489](#) 1x ARTEMIS Carbon Center Post, Ø1.8in  
[K2.0040332](#) 1x Post Main Cable, 3B, 16pin  
[K2.0039975](#) 1x BST-2, ARTEMIS 2 Bottom Stage, 16pin  
[K2.0037739](#) 1x BHM-2, Battery Hanger Module, Gen.2  
[K2.0037771](#) 1x Power Cable, BHM-2 to TST, 12V, 24V, Bat. Data  
[K2.0041327](#) 1x Support Rods 305mm, 12in, Ø19mm  
[K2.0040790](#) 1x Support Rods 120mm, 4.7in, Ø19mm  
[K2.0037757](#) 1x Hinge for Battery Hanger Module, Gen.2, Ø19mm  
[K2.0039300](#) 2x BMS-2, Battery Mounting Base, Gen.2, (naked)  
 O5.15642.0 1x Hex Key 3mm/0.11in

NOTE  
 To complete the initial order, at least one of the mandatory battery mounting sets must be ordered.  
 The customer can only put the system into operation if the basic set and the battery mounting set were ordered and delivered together.

Mandatory battery sets:  
 Gold Mount for BMS-1 / BMS-2, Set ([K0.0044355](#))  
 V-Mount for BMS-1 / BMS-2, Set ([K0.0044356](#))  
 B-Mount for BMS-2, Set ([K0.0044357](#))

Recommended optional monitor sets:  
 SM7 Pro 3G Monitor Live Set ([K0.0052196](#))  
 SM7 Pro 3G Monitor Cine Set ([K0.0052201](#))



### ARTEMIS 2, 1.8in Shorty Post, Basic Set, [KK.0044510](#)

Key features  
 Payload up to 40 Kg/88 lb  
 12V & 24V high-capacity system and camera power supply  
 LBUS, CAN Bus, tally through  
 2 x 12G video  
 1.8in telescopic center post with fine trim length adjustment  
 1.8in super-low friction gimbal with gimbal handle extension  
 Regulated high-capacity battery management  
 Interchangeable BMS-2 battery mounts  
 Battery communication

includes:  
[K2.0038249](#) 1x TST-2, ARTEMIS Top Stage, Gen. 2, 16 pin  
[K2.0041201](#) 1x Stabilizer Adapter Mount SAM-Zero  
[K2.0039443](#) 1x Cam Pwr Gen.2, ALEXA 35, Mini, AMIRA, 24 V, 8-pin  
[K2.0039448](#) 1x Cam Pwr Gen.2, 4-pin XLR, 12 V  
[K2.0041984](#) 1x 12G HD SDI BNC Cable, 0,63m/25in  
[K2.0010319](#) 1x ARTEMIS Docking Bracket, 1.8in  
[K2.0040046](#) 1x CSS Post Tool for ARTEMIS and TRINITY  
 O5.15642.0 1x Hex Key 3mm/0.11in  
[K2.0010493](#) 1x ARTEMIS Gimbal, Ø1.8in  
[K2.0010569](#) 1x Gimbal Handle Extender for 1.8in Gimbal  
[K2.0041474](#) 1x ARTEMIS Carbon Center Post, Ø1.8in, Short, No Main Cable  
[K2.0040332](#) 1x Post Main Cable, 3B, 16pin  
[K2.0039975](#) 1x BST-2, ARTEMIS 2 Bottom Stage, 16pin  
[K2.0037739](#) 1x BHM-2, Battery Hanger Module, Gen.2  
[K2.0037771](#) 1x Power Cable, BHM-2 to TST, 12V, 24V, Bat. Data  
[K2.0041327](#) 1x Support Rods 305mm, 12in, Ø19mm  
[K2.0040790](#) 1x Support Rods 120mm, 4.7in, Ø19mm  
[K2.0037757](#) 1x Hinge for Battery Hanger Module, Gen.2, Ø19mm  
[K2.0039300](#) 2x BMS-2, Battery Mounting Base, Gen.2, (naked)

NOTE  
 To complete the initial order, at least one of the mandatory battery mounting sets must be ordered.  
 The customer can only put the system into operation if the basic set and the battery mounting set were ordered and delivered together.

Mandatory battery sets:  
 Gold Mount for BMS-1 / BMS-2, Set ([K0.0044355](#))  
 V-Mount for BMS-1 / BMS-2, Set ([K0.0044356](#))  
 B-Mount for BMS-2, Set ([K0.0044357](#))

Recommended optional monitor sets:  
 SM7 Pro 3G Monitor Live Set ([K0.0052196](#))  
 SM7 Pro 3G Monitor Cine Set ([K0.0052201](#))  
 SmallHD 703 Monitor Live Set ([K0.0052692](#))

## ARTEMIS 2 Live Sets



### ARTEMIS 2 Live Ready to Shoot Set, VM, [K0.0052694](#)

includes:  
 1x [KK.0052630](#) ARTEMIS 2 Live 1.8 in Shorty, 1.8 in Gimbal  
 1x [K2.0052057](#) Power Cable 12V/12V In - 12V Hot Swap Out, BHM  
 1x [K2.0040286](#) V-Mount for BMS-1 / BMS-2  
 1x [K2.0010333](#) ARTEMIS Vest  
 1x [KK.0020297](#) ARTEMIS Carbon Spring Arm, 23kg/50.7lb, Pro Set  
 1x K2.0041765 SmallHD 703 Monitor  
 1x [K2.0052172](#) Monitor Yoke, SmallHD 7in  
 1x [K2.0050835](#) MMA-2, Second Monitor Mounting Adapter  
 1x [K2.0049885](#) CCB-2, CSS Clamp Bridge-2, 52, 19mm  
 1x [K2.0041984](#) 12G HD SDI BNC Cable, 0,63m/25in  
 1x [K2.0041723](#) Monitor Power, 12V, Lemo 0B 2pin, 0B 2pin  
 1x K2.0044490 Tally System Gen.2 / Host  
 1x K2.0044491 Tally System Gen.2 / Client  
 1x [K2.0010482](#) Tally Sensor Cable, Gen.1&2  
 2x K2.0044143 Tally Gen.2 Pwr, TST-2, Fischer 3pin to Lemo 0S 3pin, 0,35m / 13.7in  
 1x K2.0010436 Hex Key 2mm



### ARTEMIS 2 Live Ready to Shoot Set, GM, [K0.0052730](#)

includes:  
[KK.0052630](#) 1x ARTEMIS 2 Live 1.8in Shorty  
[K2.0052057](#) 1x Power Cable 12V/12V In - 12V Hot Swap Out, BHM  
[K2.0040285](#) 1x Gold Mount for BMS-1 / BMS-2  
[K2.0010333](#) 1x ARTEMIS Vest  
[KK.0020297](#) 1x ARTEMIS Carbon Spring Arm, 23kg/50.7lb, Pro Set  
 K2.0041765 1x SmallHD 703 Monitor  
[K2.0052172](#) 1x Monitor Yoke SmallHD 7in  
[K2.0050835](#) 1x MMA-2 Monitor Mounting Adapter 2  
[K2.0049885](#) 1x CCB-2, CSS Clamp Bridge-2, 52, 19mm  
[K2.0041984](#) 1x 12G HD SDI BNC Cable, 0,63m/25in  
[K2.0041723](#) 1x Monitor Power, 12V, Lemo 0B 2-pin to 0B 2-pin  
 K2.0044490 1x Tally System Gen2 / Host  
 K2.0044491 1x Tally System Gen2 / Client  
[K2.0010482](#) 1x Tally Sensor Cable, Gen.1 & 2  
 K2.0044143 2x Tally Gen.2 Pwr, TST-2, Fischer 3pin to Lemo 0S 3pin, 0,35m / 13.7in  
 1x K2.0010436 Hex Key 2mm

### ARTEMIS 2 Live 1.8in Shorty, [KK.0052630](#)

includes:  
 1x [K2.0041474](#) Carbon Center Post, 1.8in, Short  
 2x [K2.0049885](#) CCB-2, CSS Clamp Bridge-2, 52, 19mm  
 1x [K2.0010319](#) ARTEMIS Docking Bracket, 1.8in  
 1x [K2.0010493](#) ARTEMIS Gimbal, Ø1.8in  
 1x K2.0052045 BHM-3 ARTEMIS Live Battery Hanger Plate  
 1x [K2.0039300](#) BMS-2, Battery Mounting Base  
 1x [K2.0039975](#) BST-2, Bottom Stage, Gen.2, 16pin  
 1x [K2.0010569](#) Gimbal Handle Extender for 1.8in Gimbal  
 1x [K2.0037757](#) Hinge for BHM-2, Gen.2, Ø19mm  
 1x [K2.0040332](#) Post Main Cable, 3B, 16pin  
 1x O5.15642.0 Hex Key 3mm/0.11in  
 1x [K2.0041201](#) Stabilizer Adapter Mount SAM-Zero  
 1x K2.0040790 Support Rods 120mm, 4.7in, Ø19mm  
 1x K2.0041327 Support Rods 305mm, 12in, Ø19mm  
 1x [K2.0038249](#) TST-2, Top Stage, Gen.2, 16pin  
 1x [K2.0039448](#) Cam Pwr Gen.2, 4 pin XLR, 12V  
 1x [K2.0041984](#) 12G HD SDI BNC Cable, 0,63m/25in  
 1x K2.0040046 CSS Post Tool for ARTEMIS and TRINITY

NOTE  
 When ordering [KK.0052630](#) ARTEMIS 2 Live 1.8in Shorty, the following components are mandatory and need to be ordered separately:



Power Cable 12V/12V In - 12V Hot Swap Out, BHM, [K2.0052057](#)  
 Power Cable 12V/12V In - 12V/24V Out, BHM [K2.0052139](#)  
 Power Cable 12V/24V In - 12V/24V Out, BHM [K2.0052140](#)



Gold Mount for BMS-1 / BMS-2, [K2.0040285](#)  
 V-Mount for BMS-1 / BMS-2, [K2.0040286](#)  
 B-Mount 12V for BMS-2, [K2.0053830](#)

### SmallHD 703 Monitor Live Set, [K0.0052692](#)

includes:  
 K2.0041765 1x SmallHD 703 Monitor  
[K2.0052172](#) 1x Monitor Yoke SmallHD 7in  
[K2.0050835](#) 1x MMA-2 Monitor Mounting Adapter 2  
[K2.0049885](#) 1x CCB-2, CSS Clamp Bridge-2, 52, 19mm  
[K2.0041984](#) 1x 12G HD SDI BNC Cable, 0,63m/25in  
[K2.0041723](#) 1x Monitor Power, 12V, Lemo 0B 2-pin to 0B 2-pin  
 K2.0010436 1x Hex Key 2mm

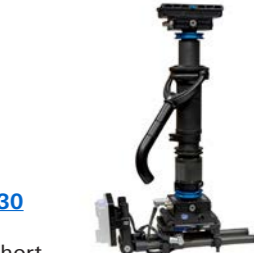

## ARTEMIS 2 Volt - Basic Set (Tiffen Volt not included)



### ARTEMIS 2, Volt Post, Basic Set, [KK.0044425](#)

This special version comes with the Volt center post. It does not include a gimbal or docking bracket.

Key features:

- Payload up to 40 Kg / 88 lb
- 12V & 24V high-capacity system and camera power supply
- LBUS, CAN Bus, tally through
- 2 x 12G video
- Regulated high-capacity battery management
- Interchangeable BMS-2 battery mounts
- Battery communication

includes:

- [K2.0041201](#) 1x Stabilizer Adapter Mount SAM-Zero
- [K2.0039443](#) 1x Cam Pwr Gen.2, ALEXA 35, Mini, AMIRA, 24 V, 8-pin
- [K2.0039448](#) 1x Cam Pwr Gen.2, 4-pin XLR, 12 V
- [K2.0041984](#) 1x 12G HD SDI BNC Cable, 0,63m/25in
- K2.0040046 1x CSS Post Tool for ARTEMIS and TRINITY
- [K2.0038249](#) 1x TST-2, ARTEMIS Top Stage, Gen. 2, 16 pin
- K2.0036904 1x ARTEMIS Carbon Center Post, ø1.74, Volt
- [K2.0040332](#) 1x Post Main Cable, 3B, 16pin
- [K2.0039975](#) 1x BST-2, ARTEMIS 2 Bottom Stage, 16pin
- K2.0037739 1x BHM-2, Battery Hanger Module, Gen.2
- [K2.0037771](#) 1x Power Cable, BHM-2 to TST, 12V, 24V, Bat. Data
- K2.0041327 1x Support Rods 305mm, 12in, Ø19mm
- K2.0040790 1x Support Rods 120mm, 4.7in, Ø19mm
- [K2.0037757](#) 1x Hinge for Battery Hanger Module, Gen.2, Ø19mm
- [K2.0039300](#) 2x BMS-2, Battery Mounting Base, Gen.2, (naked)
- [K2.0037460](#) 1x Volt Pwr Cable 0B 3-pin to 0B 2-pin, 0.4 m/1.3ft
- [K2.0037912](#) 1x SSB-3, Stabilizer System Bracket for TRINITY, MAXIMA and SAM plates

NOTE

To complete the initial order, at least one of the mandatory battery mounting sets must be ordered.

The customer can only put the system into operation if the basic set and the battery mounting set were ordered and delivered together.

Mandatory battery sets:

- Gold Mount for BMS-1 / BMS-2, Set ([K0.0044355](#))
- V-Mount for BMS-1 / BMS-2, Set ([K0.0044356](#))
- B-Mount for BMS-2, Set ([K0.0044357](#))

Recommended optional monitor sets:

- SM7 Pro 3G Monitor Live Set ([K0.0052196](#))
- SM7 Pro 3G Monitor Cine Set ([K0.0052201](#))



### ARTEMIS 2, Volt Shorty Post, Basic Set, [KK.0049907](#)

This special version comes with the short Volt center post. It does not include a gimbal or docking bracket.

- Key features: Payload up to 40 kg/88 lb, 12 V & 24 V high-capacity system and camera power supply, LBUS, CAN Bus, tally through 2 x 12G video, regulated high-capacity battery management, interchangeable BMS-2 battery mounts, battery communication.

NOTE

To complete the initial order, at least one of the mandatory battery mounting sets must be ordered. The customer can only put the system into operation if the basic set and the battery mounting set were ordered and delivered together.

includes:

- [K2.0041201](#) 1x Stabilizer Adapter Mount SAM-Zero
- K2.0049207 1x artemis Carbon Center Post, 1.74, Volt, Short, No Main Cable
- [K2.0037912](#) 1x SSB-3, Stabilizer System Bracket for TRINITY, MAXIMA, SAM plates
- K2.0040790 1x Support Rods 120mm, 4.7in, Ø19mm
- K2.0041327 1x Support Rods 305mm, 12in, Ø19mm
- [K2.0037757](#) 1x Hinge for Battery Hanger Module, Gen.2, Ø19mm
- K2.0037739 1x BHM-2, Battery Hanger Module, Gen.2
- [K2.0038249](#) 1x TST-2, ARTEMIS Top Stage, Gen. 2, 16 pin
- [K2.0040332](#) 1x Post Main Cable, 3B, 16pin
- [K2.0039300](#) 2x BMS-2, Battery Mounting Base, Gen.2, (naked)
- [K2.0039975](#) 1x BST-2, ARTEMIS 2 Bottom Stage, 16pin
- O5.15642.0 1x Hex Key 3mm/0.11in
- [K2.0039443](#) 1x Cam Pwr Gen.2, ALEXA 35, Mini, AMIRA, 24 V, 8-pin
- [K2.0039448](#) 1x Cam Pwr Gen.2, 4-pin XLR, 12 V
- K2.0040046 1x CSS Post Tool for ARTEMIS and TRINITY
- [K2.0037771](#) 1x Power Cable, BHM-2 to TST, 12V, 24V, Bat. Data
- [K2.0037460](#) 1x Volt Pwr Cable 0B 3-pin to 0B 2-pin, 0.4 m/1.3ft
- [K2.0041984](#) 1x 12G HD SDI BNC Cable, 0,63m/25in

Mandatory battery sets:

- Gold Mount for BMS-1 / BMS-2, Set ([K0.0044355](#))
- V-Mount for BMS-1 / BMS-2, Set ([K0.0044356](#))
- B-Mount for BMS-2, Set ([K0.0044357](#))

Recommended optional monitor sets:

- SM7 Pro 3G Monitor Live Set ([K0.0052196](#))
- SM7 Pro 3G Monitor Cine Set ([K0.0052201](#))

## ARTEMIS 2 Volt - Set (Tiffen Volt not included)

### Carbon Center Post, Volt Gimbal, Pro Set, [K0.0048623](#)

includes:

- K2.0036904 1x ARTEMIS Carbon Center Post, ø1.74, Volt
- [K2.0037460](#) 1x Volt Pwr Cable 0B 3-pin to 0B 2-pin, 0.4 m/1.3ft
- [K2.0037912](#) 1x SSB-3, Stabilizer System Bracket for TRINITY, MAXIMA, SAM plates
- [K2.0040244](#) 1x Arm Post ø0.74in / 18,7mm, Volt Gimbal
- [K2.0049047](#) 1x Docking Pin Sleeves for Tiffen Volt Gimbal

### Carbon Center Post, Short, Volt Gimbal, Pro Set, [K0.0053947](#)

includes:

- K2.0049207 1x ARTEMIS 2 Carbon Center Post, ø1.74, Volt, Short, No Main Cable
- [K2.0037460](#) 1x Volt Pwr Cable 0B 3-pin to 0B 2-pin, 0.4 m/1.3ft
- [K2.0037912](#) 1x SSB-3, Stabilizer System Bracket for TRINITY, MAXIMA, SAM plates
- [K2.0040244](#) 1x Arm Post ø0.74in / 18,7mm, Volt Gimbal
- [K2.0049047](#) 1x Docking Pin Sleeves for Tiffen Volt Gimbal

### ARTEMIS 2 Carbon Center Post, ø1.74, Volt, Short, No Main Cable, K2.0049207

### Volt Pwr Cable 0B 3-pin to 0B 2-pin, 0.4 m/1.3ft, [K2.0037460](#)



### SSB-3, Stabilizer System Bracket for TRINITY, MAXIMA, SAM plates, [K2.0037912](#)

### ARTEMIS Carbon Center Post, ø1.74, Volt, K2.0036904



### Arm Post 0,7 Volt Gimbl, [K2.0040244](#)



### Docking Pin Sleeves for Tiffen Volt Gimbal, [K2.0049047](#)



### 1.8in Gimbal Adapter Set f. Volt Post, [K0.0040291](#)

Includes:

- K2.0040249 1x Lower clamp sleeve, 1.8in Gimbal
- K2.0040250 1x Upper centering ring, 1.8in Gimbal



### Arm Post Clamp Ring 5/8", K2.0010510 \*



### MMA-4, Low Mode Monitor Mounting Adapter, [K2.0050573](#)

\* discontinued - only as long as stock is available

## ARTEMIS 2 Live Volt - Sets (Tiffen Volt not included)



### ARTEMIS 2 Live VOLT Ready to Shoot Set, VM, [K0.0052695](#)

- includes:
- 1x [KK.0052647](#) ARTEMIS 2 Live Volt Shorty, No Gimbal
  - 1x [K2.0052057](#) Power Cable 12V/12V In - 12V Hot Swap Out, BHM
  - 1x [K2.0040286](#) V-Mount for BMS-1 / BMS-2
  - 1x [K2.0010333](#) ARTEMIS Vest
  - 1x [KK.0020297](#) ARTEMIS Carbon Spring Arm, 23kg/50.7lb, Pro Set
  - 1x K2.0041765 SmallHD 703 Monitor
  - 1x [K2.0052172](#) Monitor Yoke, SmallHD 7in
  - 1x [K2.0050835](#) MMA-2, Second Monitor Mounting Adapter
  - 1x [K2.0049885](#) CCB-2, CSS Clamp Bridge-2, 52, 19mm
  - 1x [K2.0041984](#) 12G HD SDI BNC Cable, 0,63m/25in
  - 1x [K2.0041723](#) Monitor Power, 12V, Lemo 0B 2pin, 0B 2pin
  - 1x K2.0044490 Tally System Gen.2 / Host
  - 1x K2.0044491 Tally System Gen.2 / Client
  - 1x [K2.0010482](#) Tally Sensor Cable, Gen.1&2
  - 2x K2.0044143 Tally Gen.2 Pwr, TST-2, Fischer 3pin to Lemo 0S 3pin, 0,35m / 13.7in
  - 1x K2.0010436 Hex Key 2mm

#### NOTE

Please note that for the TIFFEN Volt gimbal version, the customer must provide the Volt gimbal, cables and Tiffen docking bracket.



### ARTEMIS 2 Live VOLT Ready to Shoot Set, GM, [K0.0052731](#)

- includes:
- 1x [KK.0052647](#) ARTEMIS 2 Live Volt Shorty, No Gimbal
  - 1x [K2.0052057](#) Power Cable 12V/12V In - 12V Hot Swap Out, BHM
  - 1x [K2.0040285](#) Gold-Mount for BMS-1 / BMS-2
  - 1x [K2.0010333](#) ARTEMIS Vest
  - 1x [KK.0020297](#) ARTEMIS Carbon Spring Arm, 23kg/50.7lb, Pro Set
  - 1x K2.0041765 SmallHD 703 Monitor
  - 1x [K2.0052172](#) Monitor Yoke, SmallHD 7in
  - 1x [K2.0050835](#) MMA-2, Second Monitor Mounting Adapter
  - 1x [K2.0049885](#) CCB-2, CSS Clamp Bridge-2, 52, 19mm
  - 1x [K2.0041984](#) 12G HD SDI BNC Cable, 0,63m/25in
  - 1x [K2.0041723](#) Monitor Power, 12V, Lemo 0B 2pin, 0B 2pin
  - 1x K2.0044490 Tally System Gen.2 / Host
  - 1x K2.0044491 Tally System Gen.2 / Client
  - 1x [K2.0010482](#) Tally Sensor Cable, Gen.1&2
  - 2x K2.0044143 Tally Gen.2 Pwr, TST-2, Fischer 3pin to Lemo 0S 3pin, 0,35m / 13.7in
  - 1x K2.0010436 Hex Key 2mm

#### NOTE

Please note that for the TIFFEN Volt gimbal version, the customer must provide the Volt gimbal, cables and Tiffen docking bracket.



### ARTEMIS 2 Live Volt Shorty - No Gimbal, [KK.0052647](#)

- includes:
- 1x K2.0049207 ARTEMIS Carbon Center Post, Ø1.74, Volt, Short
  - 2x [K2.0049885](#) CCB-2, CSS Clamp Bridge-2, 52, 19mm
  - 1x K2.0052045 BHM-3 ARTEMIS Live Battery Hanger Plate
  - 1x [K2.0039300](#) BMS-2, Battery Mounting Base
  - 1x [K2.0039975](#) BST-2, Bottom Stage, Gen.2, 16pin
  - 1x [K2.0037757](#) Hinge for BHM-2, Gen.2, Ø19mm
  - 1x [K2.0040332](#) Post Main Cable, 3B, 16pin
  - 1x O5.15642.0 Hex Key 3mm/0.11in
  - 1x [K2.0041201](#) Stabilizer Adapter Mount SAM-Zero
  - 1x K2.0040790 Support Rods 120mm, 4.7in, Ø19mm
  - 1x K2.0041327 Support Rods 305mm, 12in, Ø19mm
  - 1x [K2.0038249](#) TST-2, Top Stage, Gen.2, 16pin
  - 1x [K2.0039448](#) Cam Pwr Gen.2, 4 pin XLR, 12V
  - 1x [K2.0041984](#) 12G HD SDI BNC Cable, 0,63m/25in
  - 1x K2.0040046 CSS Post Tool for ARTEMIS and TRINITY
  - 1x [K2.0037460](#) Volt Pwr Cable 0B 3p - 0B 2p, 0.3m/0.9ft
  - 1x [K2.0037912](#) SSB-3, Stabilizer System Bracket for TRINITY, MAXI-MA, SAM plates

#### NOTE

When ordering [KK.0052630](#) ARTEMIS 2 Live 1.8in Shorty, the following components are mandatory and need to be ordered separately:



- Power Cable 12V/12V In - 12V Hot Swap Out, BHM, [K2.0052057](#)
- Power Cable 12V/12V In - 12V/24V Out, BHM [K2.0052139](#)
- Power Cable 12V/24V In - 12V/24V Out, BHM [K2.0052140](#)



- Gold Mount for BMS-1 / BMS-2, [K2.0040285](#)
- V-Mount for BMS-1 / BMS-2, [K2.0040286](#)
- B-Mount 12V for BMS-2, [K2.0053830](#)

## Monitor for Live Applications



### SmallHD 703 Monitor Live Set, [K0.0052692](#)

- includes:
- K2.0041765 1x SmallHD 703 Monitor
  - [K2.0052172](#) 1x Monitor Yoke SmallHD 7in
  - [K2.0050835](#) 1x MMA-2 Monitor Mounting Adapter 2
  - [K2.0049885](#) 1x CCB-2, CSS Clamp Bridge-2, 52, 19mm
  - [K2.0041984](#) 1x 12G HD SDI BNC Cable, 0,63m/25in
  - [K2.0041723](#) 1x Monitor Power, 12V, Lemo 0B 2-pin to 0B 2-pin
  - K2.0010436 1x Hex Key 2mm



### SM7 Pro 3G Monitor Live Set, [K0.0052196](#)

- includes:
- K2.0052052 1x SM7 Pro 3G Monitor, 7in, 3200 Nits
  - [K2.0051225](#) 1x Monitor Yoke SM7 Pro
  - [K2.0050835](#) 1x MMA-2 Monitor Mounting Adapter 2
  - [K2.0049885](#) 1x CCB-2, CSS Clamp Bridge-2, 52, 19mm
  - [K2.0041984](#) 1x 12G HD SDI BNC Cable, 0,63m/25in
  - [K2.0041723](#) 1x Monitor Power, 12V, Lemo 0B 2-pin to 0B 2-pin



### SM7 Pro 3G Monitor Cine Set, [K0.0052201](#)

- includes:
- K2.0052052 1x SM7 Pro 3G Monitor, 7in, 3200 Nits
  - [K2.0051225](#) 1x Monitor Yoke SM7 Pro
  - [K2.0051654](#) 1x MMA-1, Main Monitor Mounting Adapter
  - [K2.0041984](#) 1x 12G HD SDI BNC Cable, 0,63m/25in
  - [K2.0041723](#) 1x Monitor Power, 12V, Lemo 0B 2-pin to 0B 2-pin

# ARTEMIS 2 - Mandatory and Optional Sets



Configuration Overview | 8.1.4 / 2025.08

## Mandatory Battery Mounts



**B-Mount 12V for BMS-2**  
[K2.0053830](#)



**Gold Mount for BMS-1 / BMS-2, Set**, includes:  
Gold Mount for BMS-1 / BMS-2 (2x)

[K0.0044355](#)  
[K2.0040285](#)



**V-Mount for BMS-1 / BMS-2, Set**, includes:  
V-Mount for BMS-1 / BMS-2 (2x)

[K0.0044356](#)  
[K2.0040286](#)



**B-Mount for BMS-2, Set**, includes:  
B-Mount for BMS-2 (2x)

[K0.0044357](#)  
[K2.0040284](#)

## Live Optional Monitor Sets



**SmallHD 703 Monitor Live Set**, [K0.0052692](#)

includes:  
K2.0041765 1x SmallHD 703 Monitor  
[K2.0052172](#) 1x Monitor Yoke SmallHD 7in  
[K2.0050835](#) 1x MMA-2 Monitor Mounting Adapter 2  
[K2.0049885](#) 1x CCB-2, CSS Clamp Bridge-2, 52, 19mm  
[K2.0041984](#) 1x 12G HD SDI BNC Cable, 0,63m/25in  
[K2.0041723](#) 1x Monitor Power, 12V, Lemo 0B 2-pin to 0B 2-pin  
K2.0010436 1x Hex Key 2mm



**SM7 Pro 3G Monitor Live Set**, [K0.0052196](#)

includes:  
K2.0052052 1x SM7 Pro 3G Monitor, 7in, 3200 Nits  
[K2.0051225](#) 1x Monitor Yoke SM7 Pro  
[K2.0050835](#) 1x MMA-2 Monitor Mounting Adapter 2  
[K2.0049885](#) 1x CCB-2, CSS Clamp Bridge-2, 52, 19mm  
[K2.0041984](#) 1x 12G HD SDI BNC Cable, 0,63m/25in  
[K2.0041723](#) 1x Monitor Power, 12V, Lemo 0B 2-pin to 0B 2-pin

## Optional Monitor Parts



**ARTEMIS Monitor Bracket, Gen.2, 6in Transvideo Cine**,  
K2.0042716



**ARTEMIS Monitor Bracket, Gen.2, 8in Transvideo Cine**,  
K2.0042717



**Monitor Yoke SmallHD 7in**  
[K2.0052172](#)



**Monitor Yoke, Transvideo Stargate**, [K2.0052173](#)



**Monitor Yoke SM7 Pro**,  
[K2.0051225](#)



**Side Bracket Upgrade, 6in, SM7 Pro**, [K2.0052168](#)



**Low Mode Monitor Mounting Set**, [K0.0052258](#)



**Monitor Mounting Set, Rods**,  
[K0.0052203](#)



**MMA-1 Main Monitor Mounting Adapter**,  
[K2.0051654](#)



**MMA-2 Monitor Mounting Adapter 2**,  
[K2.0050835](#)



**MMA-3 Monitor Mounting Adapter 3**,  
[K2.0050825](#)



**MMA-4, Low Mode Monitor Mounting Adapter**, [K2.0050573](#)



**Second Monitor Mounting Set**,  
[K0.0052202](#)

## ARTEMIS Arm Sets and Vest



**SmartSystem ArmX1**,  
K2.0054618  
For TRINITY 2, ARTEMIS, 2  
Artemis 2 Live



**SmartSystem ArmX1Lite +**,  
K2.0054619  
For Artemis 2 Live



**ARTEMIS Carbon Spring Arm, 23kg/50.7lb, Pro Set**, range of payload 19-23 kg  
[KK.0020297](#)

Consists of:  
ARTEMIS Carbon Spring Arm, 23kg/50.7lb K2.0010331  
6 mm Hex Key 1/4" K2.0010435  
4 mm Hex Key / 5/32" K2.0010434  
Arm Soft Bag K2.0010463

**ARTEMIS Carbon Spring Arm, 19kg/41.8lb, Pro Set**, range of payload 15-19 kg  
KK.0020296 \*

**ARTEMIS Carbon Spring Arm, 26kg/57.3lb, Pro Set**, range of payload 23-26 kg  
KK.0020298 \*

**ARTEMIS Carbon Spring Arm, 30kg/66.1lb, Pro Set**, range of payload 26-30 kg  
KK.0039452 \*

To upgrade/downgrade the arm to another weight:



Spring Set for Spring Arm, 19kg/41.8lb K2.0010500 \*  
Spring Set for Spring Arm, 23kg/50.7lb K2.0010501 \*  
Spring Set for Spring Arm, 26kg/57.3lb K2.0010502 \*  
Spring Set for Spring Arm, 30kg/66lb K2.0037438 \*



**ARTEMIS Vest**,  
[K2.0010333](#)



**Rain Cover Spring Arm**, [K2.0010465](#)

\* discontinued - only as long as stock is available

## CSS Protection



**Case TRINITY 2 & ARTEMIS 2, Rig, SKB 3i-4217-7**, [K2.0044440](#)  
for ARTEMIS 2 / TRINITY 2



**Rain Cover Lower Sled**  
[K2.0010466](#)

# ARTEMIS 2 Live - Power Options



Configuration Overview | 8.1.5 / 2025.02

## Mandatory Battery Mounts

V-Mount for BMS-1 / Gold Mount for BMS-1 / B-Mount 12V for BMS-2, [K2.0040286](#)    V-Mount for BMS-1 / Gold Mount for BMS-1 / B-Mount 12V for BMS-2, [K2.0040285](#)    V-Mount for BMS-1 / Gold Mount for BMS-1 / B-Mount 12V for BMS-2, [K2.0053830](#)    V-Mount for BMS-1 / Gold Mount for BMS-1 / B-Mount 12V for BMS-2, [K2.0040286](#)    Gold Mount for BMS-1 / B-Mount 12V for BMS-2, [K2.0040285](#)    V-Mount for BMS-1 / Gold Mount for BMS-1 / B-Mount 12V for BMS-2, [K2.0053830](#)    V-Mount for BMS-1 / Gold Mount for BMS-1 / B-Mount 12V for BMS-2, [K2.0040286](#)    Gold Mount for BMS-1 / B-Mount 12V for BMS-2, [K2.0040285](#)    V-Mount for BMS-1 / Gold Mount for BMS-1 / B-Mount 12V for BMS-2, [K2.0053830](#)



BMS-2, Battery Mounting Base, [K2.0039300](#)

BMS-2, Battery Mounting Base, [K2.0039300](#)

BMS-2, Battery Mounting Base, [K2.0039300](#)

BMS-2, Battery Mounting Base, [K2.0039300](#)

12V Hot Swap

12V IN

12V Hot Swap Out

12V & 24V

12V IN

12V IN

12V Out

24V Out

Power Cable 12V/12V In - 12V Hot Swap Out, BHM, [K2.0052057](#)

Power Cable 12V/12V In - 12V/24V Out, BHM, [K2.0052139](#)

B-Mount 24 V for BMS-2, [K2.0040284](#)

V-Mount for BMS-1 / Gold Mount for BMS-1 / B-Mount 12V for BMS-2, [K2.0040286](#)    V-Mount for BMS-1 / Gold Mount for BMS-1 / B-Mount 12V for BMS-2, [K2.0040285](#)    V-Mount for BMS-1 / Gold Mount for BMS-1 / B-Mount 12V for BMS-2, [K2.0053830](#)



BMS-2, Battery Mounting Base, [K2.0039300](#)

BMS-2, Battery Mounting Base, [K2.0039300](#)

12V & 24V

24V IN

12V IN

12V IN

12V Out

24V Out

Power Cable, D-Tab to BHM-3, 12V, [K2.0053449](#)

Power Cable 12V/24V In - 12V/24V Out, BHM, [K2.0052140](#)

# TRINITY 2 - General Overview



Configuration Overview | 8.2.0 / 2025.08

## TRINITY 2 Overview

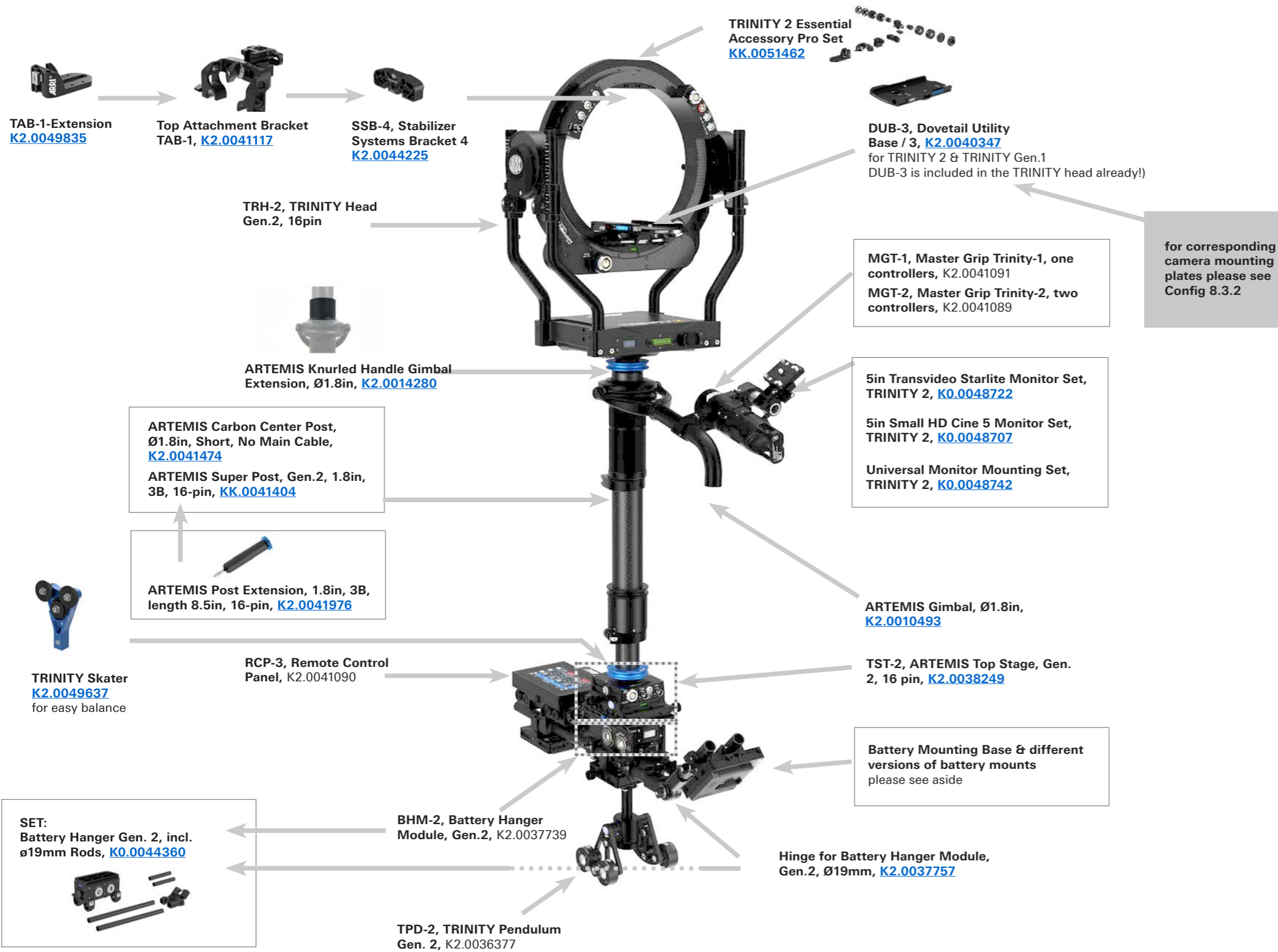

## ARTEMIS Arm Sets and Vest

**SmartSystem ArmX1,**  
K2.0054618  
For TRINITY 2, ARTEMIS, 2  
Artemis 2 Live

**SmartSystem ArmX1Lite +,**  
K2.0054619  
For Artemis 2 Live

**ARTEMIS Carbon Spring Arm, 23kg/50.7lb, Pro Set, range of payload 19-23 kg**  
Consists of:  
ARTEMIS Carbon Spring Arm, 23kg/50.7lb  
6 mm Hex Key 1/4"  
4 mm Hex Key / 5/32"  
Arm Soft Bag

	<a href="#">KK.0020297</a> K2.0010331 K2.0010435 K2.0010434 K2.0010463
--	--

**ARTEMIS Carbon Spring Arm, 19kg/41.8lb, Pro Set, range of payload 15-19 kg**

**KK.0020296 \***

**ARTEMIS Carbon Spring Arm, 26kg/57.3lb, Pro Set, range of payload 23-26 kg**

**KK.0020298 \***

**ARTEMIS Carbon Spring Arm, 30kg/66.1lb, Pro Set, range of payload 26-30 kg**

**KK.0039452 \***

**Rain Cover Spring Arm,** K2.0010465

**ARTEMIS Vest,**  
K2.0010333

**\* discontinued - only as long as stock is available**

## Basic Set



### TRINITY 2, Basic Set, [KK.0044429](#)

Key features:  
Five-axis fully stabilized hybrid camera stabilizer system, roll +/- 360°, tilt + 60°/-110°, payload up to 30 kg/66 lb, 12 V & 24 V high-capacity system power supply, LBUS, CAN Bus, tally and battery communication, 12G video, 12G reclocker, intuitive GUI and touch panel based remote controller, high-capacity battery management with battery communication, interchangeable BMS-2 battery mounts, optional wireless radio modules.

includes:  
[K2.0042636](#) 1x TRH-2, TRINITY 2 Head, 16pin, X-Body  
[K2.0042631](#) 1x TRH-2 Ring Main Cable, Standard, 0,65m/25.5in  
[K2.0040347](#) 1x DUB-3, Dovetail Utility Base / 3  
[K2.0041201](#) 1x Stabilizer Adapter Mount SAM-Zero  
[K2.0039443](#) 1x Cam Pwr Gen.2, ALEXA 35, Mini, AMIRA, 24 V, 8-pin  
[K2.0039448](#) 1x Cam Pwr Gen.2, 4-pin XLR, 12 V  
[K2.0041984](#) 1x 12G HD SDI BNC Cable, 0,63m/25in  
[K2.0010319](#) 1x ARTEMIS Docking Bracket, 1.8in  
[K2.0040046](#) 1x CSS Post Tool for ARTEMIS and TRINITY  
[O5.15642.0](#) 1x Hex Key 3mm/0.11in  
[K2.0010493](#) 1x ARTEMIS Gimbal, Ø1.8in  
[K2.0010569](#) 1x Gimbal Handle Extender for 1.8in Gimbal  
[K2.0010489](#) 1x ARTEMIS Carbon Center Post, Ø1.8in  
[K2.0040332](#) 1x Post Main Cable, 3B, 16pin  
[K2.0038249](#) 1x TST-2, ARTEMIS Top Stage, Gen. 2, 16 pin  
[K2.0037739](#) 1x BHM-2, Battery Hanger Module, Gen.2  
[K2.0037771](#) 1x Power Cable, BHM-2 to TST, 12V, 24V, Bat. Data  
[K2.0041327](#) 1x Support Rods 305mm, 12in, Ø19mm  
[K2.0040790](#) 1x Support Rods 120mm, 4.7in, Ø19mm  
[K2.0037757](#) 1x Hinge for Battery Hanger Module, Gen.2, Ø19mm  
[K2.0039300](#) 2x BMS-2, Battery Mounting Base, Gen.2, (naked)  
[K2.0036377](#) 1x TPD-2, TRINITY Pendulum Gen. 2  
[K2.0033569](#) 4x Counterweight, CW-1, 150gr  
[K2.0041090](#) 1x RCP-3, Remote Control Panel  
[K2.0042837](#) 1x CSS Clamp Bridge 52, 19mm  
[K2.0043883](#) 1x RCP-3, FS Can Bus Cable, 25cm/10in

NOTE  
To complete the initial order, at least one of the mandatory battery mounting, joystick and monitor sets must be ordered. The customer can only put the system into operation if the basic set and the battery, joystick and monitor sets were ordered and delivered together.

Mandatory battery sets:  
[K0.0044355](#), [K0.0044356](#), [K0.0044357](#)  
 Mandatory joystick sets:  
[K0.0044362](#), [K0.0044363](#)  
 Mandatory monitor sets:  
[K0.0048722](#), [K0.0048707](#), [K0.0048742](#)

## Mandatory Battery Mounts

**Gold Mount for BMS-1 / BMS-2, Set**, includes: [K0.0044355](#)  
 Gold Mount for BMS-1 / BMS-2 (2x) [K2.0040285](#)

**V-Mount for BMS-1 / BMS-2, Set**, includes: [K0.0044356](#)  
 V-Mount for BMS-1 / BMS-2 (2x) [K2.0040286](#)

**B-Mount for BMS-2, Set**, includes: [K0.0044357](#)  
 B-Mount for BMS-2 (2x) [K2.0040284](#)

**B-Mount 12V for BMS-2,**  
[K2.0053830](#)

## Mandatory Joysticks Sets

**Master Grip TRINITY 2, One Controller Set** [K0.0044362](#)  
 includes:  
 MGT-1, Master Grip Trinity-1, one controllers [K2.0041091](#)  
 12G HD SDI BNC Cable, 0,63m/25in [K2.0041984](#)  
 TRINITY 2 Joystick Cable, 75cm/29.5 in [K2.0043861](#)  
 MTG Monitor Pwr, Lemo 0B, 2pin [K2.0038998](#)  
 MTG Monitor Pwr, Lemo 0B, 5pin [K2.0038999](#)

**Master Grip TRINITY 2, Two Controllers Set** [K0.0044363](#)  
 includes:  
 MGT-2, Master Grip TRINITY 2, two controllers [K2.0041089](#)  
 12G HD SDI BNC Cable, 0,63m/25in [K2.0041984](#)  
 TRINITY 2 Joystick Cable, 75cm/29.5 in [K2.0043861](#)  
 MTG Monitor Pwr, Lemo 0B, 2pin [K2.0038998](#)  
 MTG Monitor Pwr, Lemo 0B, 5pin [K2.0038999](#)

## Mandatory Monitor Sets

**5in Transvideo Starlite Monitor Set, TRINITY 2,** [K0.0048722](#)  
 includes:  
 Transvideo StarliteHD5-ARRI OLED Monitor [K2.0006960](#)  
 Adapter ø19mm with 1/4in thread [K2.0048648](#)  
 Articulating arm, 5in [K2.0048700](#)

**5in Small HD Cine 5 Monitor Set, TRINITY 2,** [K0.0048707](#)  
 includes:  
 SmallHD Cine 5 Monitor, 5in [K2.0048548](#)  
 Adapter ø19mm with 1/4in thread [K2.0048648](#)  
 Articulating arm, 5in [K2.0048700](#)

**Universal Monitor Mounting Set, TRINITY 2,** [K0.0048742](#)  
 Includes:  
 Adapter ø19mm with 1/4in thread [K2.0048648](#)  
 Articulating arm, 5in [K2.0048700](#)

**Adapter ø15mm with 1/4in thread,** [K2.0048645](#)

## Balance and Fibration-free Components



**TRINITY 2 Essential Accessory Pro Set, [KK.0051462](#)**  
 includes:  
[K2.0044225](#) 1x SSB-4, Stabilizer Systems Bracket 4  
[K2.0047643](#) 1x NATO Accessory Rail NAR-30  
[K2.0047771](#) 1x NATO Rail Clamp NRC-5  
[K2.0041117](#) 1x Top Attachment Bracket TAB-1  
[K2.0049835](#) 1x TAB-1-Extension  
[K2.0042826](#) 2x 3/8-16 Extension  
[K2.0033569](#) 4x Counterweight, CW-1, 150gr  
[K2.0043875](#) 2x Counterweight CW-3, 50gr, 0.110 lbs  
[K2.0043876](#) 2x Counterweight CW-4, 25gr, 0.055 lbs

**TRINITY 2 Essential Accessory Kit, [KK.0049586](#) \***  
 includes:  
[K2.0044225](#) 1x SSB-4, Stabilizer Systems Bracket 4  
[K2.0041117](#) 1x Top Attachment Bracket TAB-1  
[K2.0033852](#) 1x Accessory Rail Cube ARC-1  
[K2.0042826](#) 2x 3/8-16 Extension  
[K2.0033569](#) 4x Counterweight, CW-1, 150gr  
[K2.0043875](#) 2x Counterweight CW-3, 50gr, 0.110 lbs  
[K2.0043876](#) 2x Counterweight CW-4, 25gr, 0.055 lbs  
[K2.0034009](#) 1x Accessory Rail Small ARS-2

**19mm, 3/8 Extension, Steel, Set, [KK.0053621](#)**  
 includes:  
[K2.0052729](#) 1x 19mm, 3/8, Extension, Steel, F-F  
[K2.0052728](#) 1x 19mm, 3/8, Extension, Steel, M-F

**TRINITY Skater**  
[K2.0049637](#)  
 for easy balance

\* discontinued - only as long as stock is available

# TRINITY 2, TRINITY Gen. 1 - Compatible Accessories



Configuration Overview | 8.2.2 / 2025.02

## TRINITY 2, TRINITY Gen. 1 - Balance



**Pendulum Gen.2 Set, incl. Weights, [K0.0044361](#)**  
includes:  
K2.0036377 1x TPD-2, TRINITY Pendulum Gen. 2  
[K2.0033569](#) 4x Counterweight, CW-1, 150gr



**Counterweight Set, 150 gr, 300 gr for SRH, TRINITY, MAXIMA, [KK.0033710](#)**



**Counterweight, CW-2, 300gr, 0,66 lbs, [K2.0033574](#)**



**Counterweight, CW-1, 150gr, 0,33 lbs, [K2.0033569](#)**



**Counterweight, CW-3, 50gr, 0.110 lbs, [K2.0043875](#)**



**Counterweight, CW-4, 25gr, 0.055 lbs, [K2.0043876](#)**



**3/8-16 Extension, [K2.0042826](#)**



**Counterweight Ring, Donut, 800 g, [K2.0031236](#)**

## TRINITY 2, TRINITY Gen. 1 - Brackets and Mounting



**MSP-1, Multi Support Plate for TRINITY, [K2.0015385](#)**



**Clamp 3/8in for RAB-1, [K2.0047286](#)**



**Universal Monitor Mounting Set, TRINITY 2, [K0.0048742](#)**



**TRINITY 2 Essential Accessory Pro Set [KK.0051462](#)**



**Universal Post Clamp 1.8-1.5in, Gen. 2, [K2.0042719](#)**



**CSS Mitchell Mount, K2.0010427**



**CSS Euro Mount K2.0010426 \***



**ARTEMIS Knurled Handle Gimbal Extension, Ø1.8in, [K2.0014280](#)**



**CCB-2, CSS Clamp Bridge-2, 52, 19mm, [K2.0049885](#)**



**CSS Clamp Bridge 52, 19mm, [K2.0042837](#)**



**Stabilizer System Bracket SSB-1 for TRINITY, SAM plates, [K2.0035956](#)**



**SSB-4, Stabilizer Systems Bracket 4, [K2.0044225](#)**



**SSB-6, Stabilizer System Bracket 6, Basic Set [KK.0049354](#)**



**Rod Mounting Bracket RMB-5, K2.0014827**



**Rod Mounting Bracket RMB-6, K2.0020163**



**Rod Mounting Bracket RMB-3, K2.0006186**



**19mm, 3/8 Extension, Steel, Set, [KK.0053621](#)**



**DRW-1, Single Wheel, Mounting Set, [KK.0051464](#)**

**\* discontinued - only as long as stock is available**

## Plates and Dovetails

for corresponding Plates and Dovetails please see Configuration Overview 8.3.2

## Nato Rails

for further NATO Rails parts please see Configuration Overview 5.6.1

## Camera-Top Mounting in TRINITY-Ring



**Top Attachment Bracket TAB-1, [K2.0041117](#)**



**TAB-1-Extension [K2.0049835](#)**

## Controller for TRINITY 2



**RCP-3, Remote Control Panel, K2.0041090**



**RCP-3, FS Can Bus Cable, 25cm/10in, [K2.0043883](#)**

## CSS Protection



**Case TRINITY 2 compl. System, Pelican 1780, incl. Foam inlay, [K2.0048641](#)**



**Case TRINITY 2 compl. System, Pelican 1780, empty, [K2.0044439](#)**



**Case TRINITY 2 & ARTEMIS 2, Rig, SKB 3i-4217-7, [K2.0044440](#)**



**Foam Inlay TRINITY 2 compl. System, Pelican 1780 [K2.0048282](#)**



**Rain Cover Lower Sled [K2.0010466](#)**



**Case TRINITY Head, SKB 3i-2317-14BE, [K2.0016275](#)**

## TRINITY 2 - Pan Axis



### Pan Axis for TRINITY 2, Set, [KK.0051466](#)

includes:  
 K2.0050764 1x TRINITY 2 Pan Axis Module  
[K2.0050770](#) 1x Communication Cable, TRINITY 2 Pan Axis  
[K2.0040332](#) 1x Post Main Cable, 3B, 16pin  
[K2.0019298](#) 1x SRH Mitchell Mount, Metric  
[K2.0019302](#) 1x SRH FS CAN Bus Cable, 10m/32.8ft  
[K2.0019306](#) 1x SRH High-Capacity Battery Power Cable, 12V/24V, 0.5m/1.64ft  
[K2.0021427](#) 1x SRH High-Capacity Battery Power Cable 24V, 3-pin XLR, 10m/33ft  
[K2.0021428](#) 1x SRH High-Capacity Battery Power Cable 12V, 4-pin XLR, 10m/33ft  
[K2.0038756](#) 1x Wrench for SRH Castle Nut, Mitchell Mount

## Power / Battery

for quick installation of the battery mount on 19 mm rods



### BMS-3, Pro Set, V-Mount, [KK.0049408](#), includes:

K2.0048655 1x BMS-3, Battery Mounting Base naked  
[K2.0040286](#) 1x V-Mount for BMS-1 / BMS-2  
[K2.0042837](#) 1x CSS Clamp Bridge 52, 19mm  
[K2.0036902](#) 1x ERM D-Tap Pwr Cable, 0B Lemo 2-pin to D-Tap, 1m/3.2ft  
[K2.0021422](#) 1x 12V Battery Power Cable, D-Tab, 4-pin XLR, 1.5m/5ft

### BMS-3, Pro Set, Gold-Mount, [KK.0049409](#), includes:

K2.0048655 1x BMS-3, Battery Mounting Base naked  
[K2.0040285](#) 1x Gold Mount for BMS-1 / BMS-2  
[K2.0042837](#) 1x CSS Clamp Bridge 52, 19mm  
[K2.0036902](#) 1x ERM D-Tap Pwr Cable, 0B Lemo 2-pin to D-Tap, 1m/3.2ft  
[K2.0021422](#) 1x 12V Battery Power Cable, D-Tab, 4-pin XLR, 1.5m/5ft

## TRINITY 2 - Pan Axis Controller

### EJS-1, EJW-1, Controller Set, [KK.0051502](#)

includes:  
 K2.0049229 1x EJS-1, External Joystick, Broadcast  
 K2.0049230 1x EJW-1, External Jog-Wheels  
 K2.0006750 2x Cable LBUS - LBUS (0.3m/1ft)  
[K2.0042837](#) 2x CSS Clamp Bridge 52, 19mm  
 K2.0047854 1x NATO Accessory Rail NAR-60  
 K2.0049419 1x NATO Rail Clamp NRC-3



### EJS-1 Controller Set, [KK.0051103](#)

includes:  
 K2.0049229 1x EJS-1, External Joystick, Broadcast  
 K2.0006750 1x Cable LBUS - LBUS (0.3m/1ft)  
[K2.0042837](#) 1x CSS Clamp Bridge 52, 19mm



### EJW-1, Controller Set, [KK.0051102](#)

includes:  
 K2.0049230 1x EJW-1, External Jog-Wheels  
 K2.0006750 1x Cable LBUS - LBUS (0.3m/1ft)  
[K2.0042837](#) 1x CSS Clamp Bridge 52, 19mm  
 K2.0047854 1x NATO Accessory Rail NAR-60  
 K2.0049419 1x NATO Rail Clamp NRC-3



## ERM Sets



The external radio module offers reliable wireless communication over 2.4 GHz between the remote control and the Stabilized Remote Head 360 EVO and SRH-3 and SRH-360. The range of up to 1000 m/3280 ft. is based on so-called channel hopping.

### ERM-2400 2.4 GHz RXD-TXD Basic Set, SRH, [KK.0040049](#)

includes:  
[K2.0037428](#) 2x ERM-2400, SRH, Single Module  
[K2.0033763](#) 2x ERM-2400 Rubber Duck Antenna  
[K2.0033762](#) 2x SRH FS CAN Bus Cable, 1m/3.2ft  
[K2.0033761](#) 1x ERM Power Cable, ERM-2400 & ERM-900

Range:  
 Up to 1000 meter / 3280 ft.

further informations regarding ERM please see Config 8.5.0 & 8.5.1

## TRINITY 2 - Pan Axis Controller

### DRW-1 Digital Remote Wheel, Single Wheel Set, [KK.0051504](#), includes:

K2.0051132 1x DRW-1 Mounting Base 2  
[KK.0021211](#) 1x DRW-1 Digital Remote Wheel, Third Wheel Set  
[K2.0042837](#) 1x CSS Clamp Bridge 52, 19mm



### DRW-1, Digital Remote Wheel, Single Wheel Set, 160mm, [KK.0053982](#), includes:

K2.0019319 1x DRW-1 Module  
 K2.0051672 1x Hand Wheel 160 complete  
 K2.0019318 1x DRW-1 Modul Mounting Bracket  
 K2.0051132 1x DRW-1 Mounting Base 2  
[K2.0042837](#) 1x CSS Clamp Bridge 52, 19mm



### DEH-2 Pro Set, Left Zoom Rocker Master Grip, OCU-1, [K0.0048724](#), Includes:

[K2.0044672](#) 1x DEH-2, Digital Encoder Head 2  
 K2.0020002 1x Operator Control Unit OCU-1 Basic Set  
 K2.0020003 1x OCU-1 Rosette Bracket  
 K2.0009490 1x Master Grip Left Rocker MLR-1  
 K2.0048586 2x Cartoni special pan bar ø20mm  
 K2.0012919 2x Handgrip Pan Bar Adapter 20mm  
 K2.0006752 2x Cable LBUS - LBUS (0.8m/2.6ft)  
 K2.0006753 2x Cable LBUS - LBUS (1.5m/5ft)

### DEH-2 Pro Set, Right Zoom Rocker Master Grip, OCU-1, [K0.0048723](#)

Includes:  
[K2.0044672](#) 1x DEH-2, Digital Encoder Head 2  
 K2.0020002 1x Operator Control Unit OCU-1 Basic Set  
 K2.0020003 1x OCU-1 Rosette Bracket  
 K2.0009493 1x Master Grip Right Rocker MRR-1  
 K2.0048586 2x Cartoni special pan bar ø20mm  
 K2.0012919 2x Handgrip Pan Bar Adapter 20mm  
 K2.0006752 2x Cable LBUS - LBUS (0.8m/2.6ft)  
 K2.0006753 2x Cable LBUS - LBUS (1.5m/5ft)

## TRINITY 2 - Pan Axis Mounting



### RCP-3, Controller, 19mm Mounting Set, [KK.0051503](#)

includes:  
[K2.0049453](#) 1x Mitchell Wedge Lock Set  
[K2.0050433](#) 1x CSS Mitchell Base Plate  
[K2.0049885](#) 2x CCB-2, CSS Clamp Bridge-2, 52, 19mm  
 K2.0040791 1x Support Rods 430mm, 16.9in, Ø19mm



### SSB-6, Stabilizer System Bracket 6, Basic Set, [KK.0049354](#)

includes:  
 K2.0048349 1x SSB-6, Stabilizer Systems Bracket 6 extension  
 K2.0048350 1x SSB-6, Stabilizer Systems Bracket 6



### DRW-1, Single Wheel, Mounting Set, [KK.0051464](#)

includes:  
 K2.0019318 1x DRW-1 Modul Mounting Bracket  
 K2.0051132 1x DRW-1 Mounting Base 2  
[K2.0042837](#) 1x CSS Clamp Bridge 52, 19mm



### CSS Clamp Bridge 52, 19mm, [K2.0042837](#)



### Monitor Adapter for Transvideo K2.0014831



### Monitor Adapter for Small HD, K2.0014832



### Rod Mounting Bracket RMB-3, K2.0006186

## RCP-3



### RCP-3, Remote Control Panel, K2.0041090



### RCP-3, FS Can Bus Cable, 25cm/10in, [K2.0043883](#)

# TRINITY 2 - Pan Axis Configuration



Configuration Overview | 8.2.4 / 2024.11

## TRINITY 2 - Pan Axis



ERM Sets please see Config 8.5.0

SSB-6, Stabilizer Systems Bracket 6, K2.0048350

TRINITY 2 upgrade needed: Communication Socket Panel, TRINITY 2 Pan Axis Upgrade [K2.0050768](#)

connections on the right side of the modules (Pan Axis -> TRINITY 2)

SRH FS CAN Bus Cable, 10m/32.8ft, [K2.0019302](#)

SRH-3 FS CAN Bus Cable, 1m/3.2ft, [K2.0033762](#)



SRH-3 FS CAN Bus Cable, 1m/3.2ft, [K2.0033762](#)

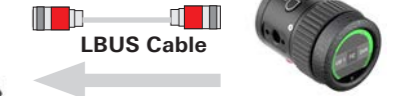

Operator Control Unit OCU-1 Basic Set, K2.0020002



RCP-3, Remote Control Panel, K2.0041090

or / alternativ



DRW-1 Digital Remote Wheel, Single Wheel Set, [KK.0051504](#)

or / alternativ



DEH-2 Pro Set, Left Zoom Rocker Master Grip, OCU-1, [K0.0048724](#)

DEH-2 Pro Set, Right Zoom Rocker Master Grip, OCU-1, [K0.0048723](#)



EJS-1, EJW-1, Controller Set, [KK.0051502](#)



EJS-1 Controller Set, [KK.0051103](#)

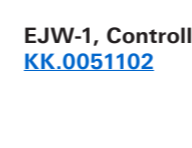

EJW-1, Controller Set, [KK.0051102](#)

LBUS Cable



RCP-3, Controller, 19mm Mounting Set, [KK.0051503](#)



BMS-3, Pro Set, V-Mount, [KK.0049408](#)

BMS-3, Pro Set, Gold-Mount, [KK.0049409](#)



ERM Sets please see Config 8.5.0

Extension cable

Optional EXTENSION CABLES:  
 SRH FS CAN Bus Cable, 1m/3.2ft, [K2.0033762](#)  
 SRH FS CAN Bus Cable, 10m/32.8ft, [K2.0019302](#)  
 SRH FS CAN Bus Cable, 25m/82ft, [K2.0019301](#)

Rod Mounting Bracket RMB-3, K2.0006186

external power option

TRINITY 2 Pan Axis Module, K2.0050764

SRH Mitchell Mount, Metric [K2.0019298](#) included

Wrench for SRH Castle Nut, Mitchell Mount, [K2.0038756](#) included

- [K2.0050770](#) 1x Communication Cable, TRINITY 2 Pan Axis
- [K2.0040332](#) 1x Post Main Cable, 3B, 16pin
- [K2.0019302](#) 1x SRH FS CAN Bus Cable, 10m/32.8ft - Extension Cable
- [K2.0019306](#) 1x SRH High-Capacity Battery Power Cable, 12V/24V, 0.5m/1.64ft
- [K2.0021427](#) 1x SRH High-Capacity Battery Power Cable 24V, 3-pin XLR, 10m/33ft
- [K2.0021428](#) 1x SRH High-Capacity Battery Power Cable 12V, 4-pin XLR, 10m/33ft

# Power/Battery Options - ARTEMIS & TRINITY

Configuration Overview | 8.3.0 / 2024.11

## artemis Gen 1 / TRINITY Gen. 1

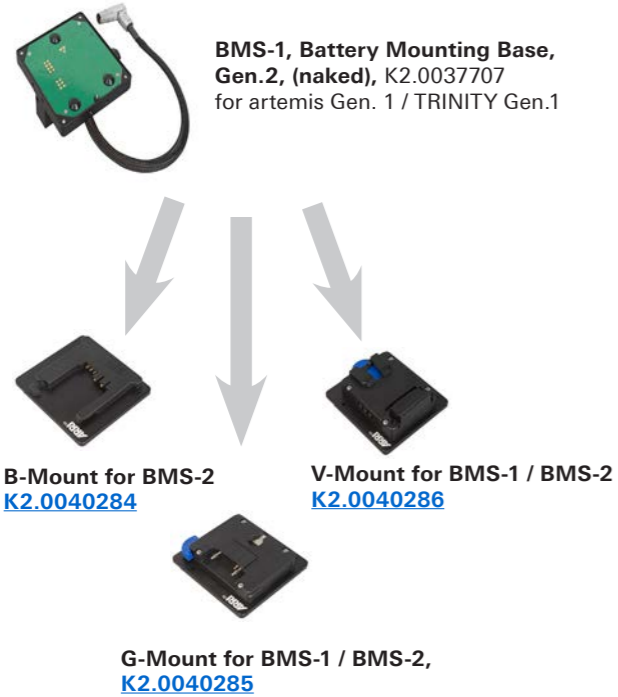

## ARTEMIS 2 / TRINITY 2

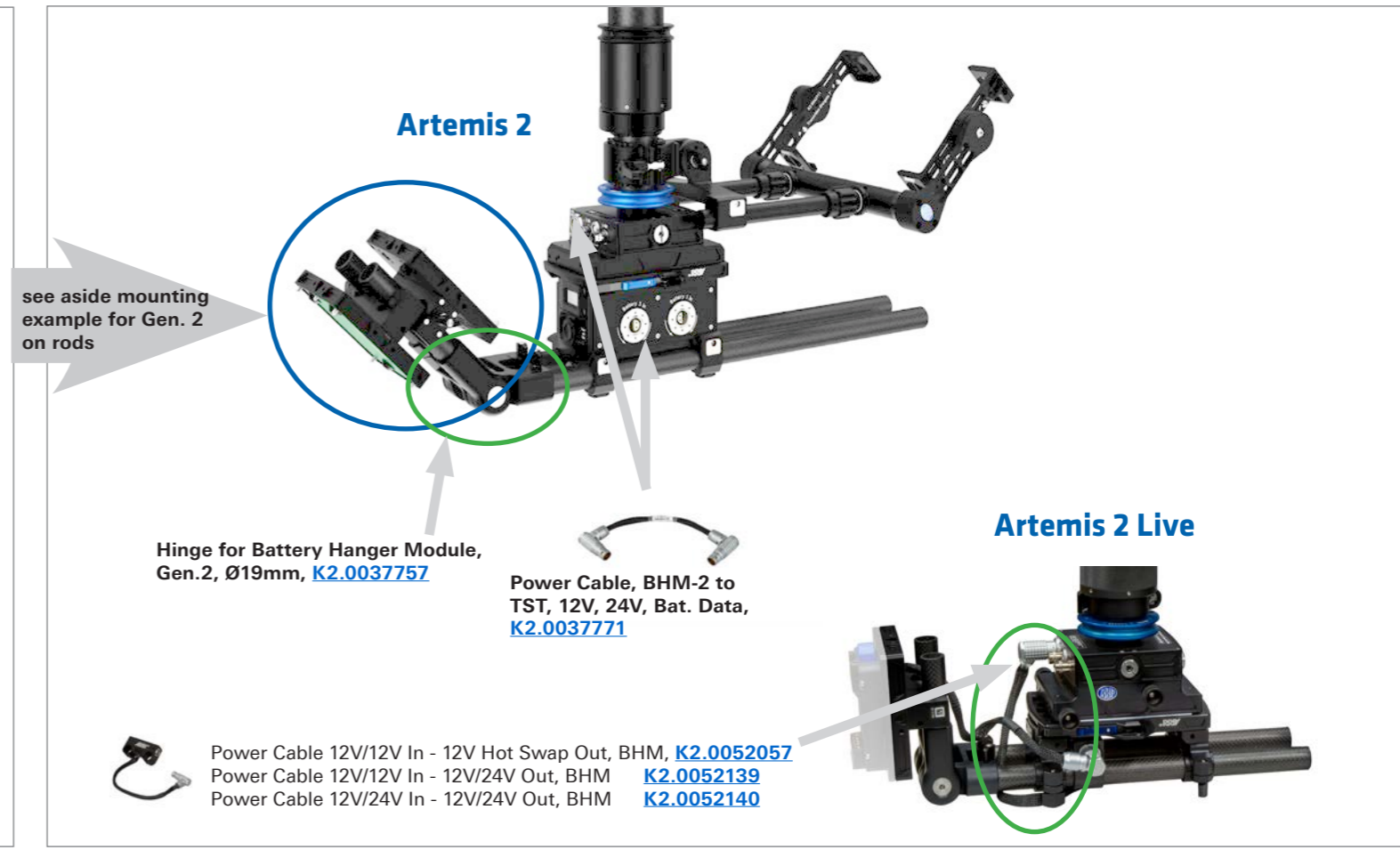
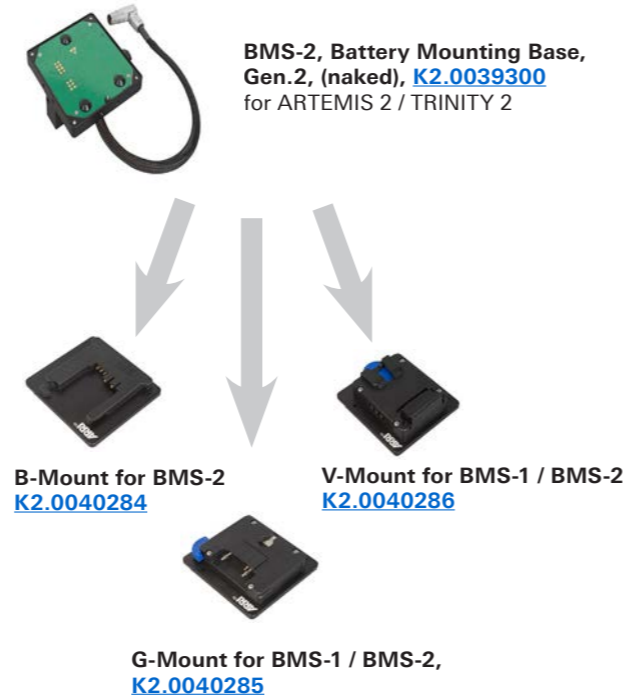

**BMS-1 Upgrade Set, Gold Mount, incl. 3 Mounts, [K0.0044358](#)** includes.  
K2.0037707 3x BMS-1, Battery Mounting Base, Gen.2, (naked)  
[K2.0040285](#) 3x Gold Mount for BMS-1 / BMS-2

**BMS-1 Upgrade Set, V-Mount, incl. 3 Mounts, [K0.0044359](#)** includes.  
K2.0037707 3x BMS-1, Battery Mounting Base, Gen.2, (naked)  
[K2.0040286](#) 3x V-Mount for BMS-1 / BMS-2

## Brackets



## 19 mm Studio Rods

- Single Support Rod 540mm/21.3in, Ø19mm, K2.0014959, carbon fibre, black**
- Single Support Rod 340mm/13.4in, Ø19mm, K2.0014954, carbon fibre, black**
- Single Support Rod 150mm, 5.9in, Ø19mm, K2.0014961, stainless steel, lightweight**
- Single Support Rod 90mm, 3.5in, Ø19mm, K2.0014960, stainless steel, lightweight**
- Single Support Rod 76mm, 3in, Ø19mm, K2.0043811, carbon fibre, black**
- Support Rods 540mm/21.3in, Ø19mm, K2.72028.0, stainless steel**
- Support Rods 440mm/17.3in, Ø19mm, K2.0001022, stainless steel**
- Support Rods 430mm, 16.9in, Ø19mm, K2.0040791, carbon fibre, black**
- Support Rods 340mm/13.4in, Ø19mm, K2.66269.0, stainless steel, lightweight**
- Support Rods 305mm, 12in, Ø19mm, K2.0041327, carbon fibre, black**
- Support Rods 240mm/9.4in, Ø19mm, K2.66270.0, stainless steel, lightweight**
- Support Rods 150mm/5.9in, Ø19mm, K2.0016090, stainless steel, lightweight**
- Support Rods 120mm, 4.7in, Ø19mm, K2.0040790, carbon fibre, black**
- Support Rods 90mm/3.5in, Ø19mm, K2.0016088, stainless steel, lightweight**



## ARTEMIS Arm Sets and Vest



**SmartSystem ArmX1**,  
K2.0054618  
For TRINITY 2, ARTEMIS, 2  
Artemis 2 Live

**SmartSystem ArmX1Lite +**,  
K2.0054619  
For Artemis 2 Live



**ARTEMIS Carbon Spring Arm, 23kg/50.7lb, Pro Set, range of payload 19-23 kg** [KK.0020297](#)

Consists of:  
 ARTEMIS Carbon Spring Arm, 23kg/50.7lb K2.0010331  
 6 mm Hex Key 1/4" K2.0010435  
 4 mm Hex Key / 5/32" K2.0010434  
 Arm Soft Bag K2.0010463

**ARTEMIS Carbon Spring Arm, 19kg/41.8lb, Pro Set, range of payload 15-19 kg** [KK.0020296 \\*](#)

**ARTEMIS Carbon Spring Arm, 26kg/57.3lb, Pro Set, range of payload 23-26 kg** [KK.0020298 \\*](#)

**ARTEMIS Carbon Spring Arm, 30kg/66.1lb, Pro Set, range of payload 26-30 kg** [KK.0039452 \\*](#)

**Rain Cover Spring Arm**, [K2.0010465](#)



**ARTEMIS Vest**,  
[K2.0010333](#)

*\* discontinued - only as long as stock is available*

## Configuration Arm



**ARTEMIS Gimbal, Ø1.8in**,  
[K2.0010493](#)

**Arm Post 0,7 Volt Gimbl**,  
[K2.0040244](#)

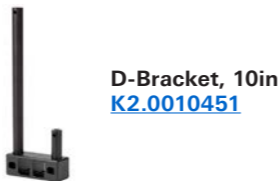

**D-Bracket, 10in**  
[K2.0010451](#)

Or

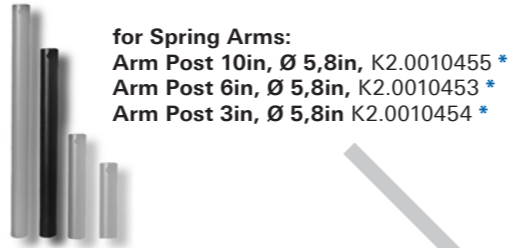

for Spring Arms:  
**Arm Post 10in, Ø 5,8in**, K2.0010455 \*  
**Arm Post 6in, Ø 5,8in**, K2.0010453 \*  
**Arm Post 3in, Ø 5,8in**, K2.0010454 \*

*\* discontinued - only as long as stock is available*



**ARTEMIS Vest**,  
[K2.0010333](#)

**ARTIMES Spring Arm Carbon**

## Configuration C-Stand

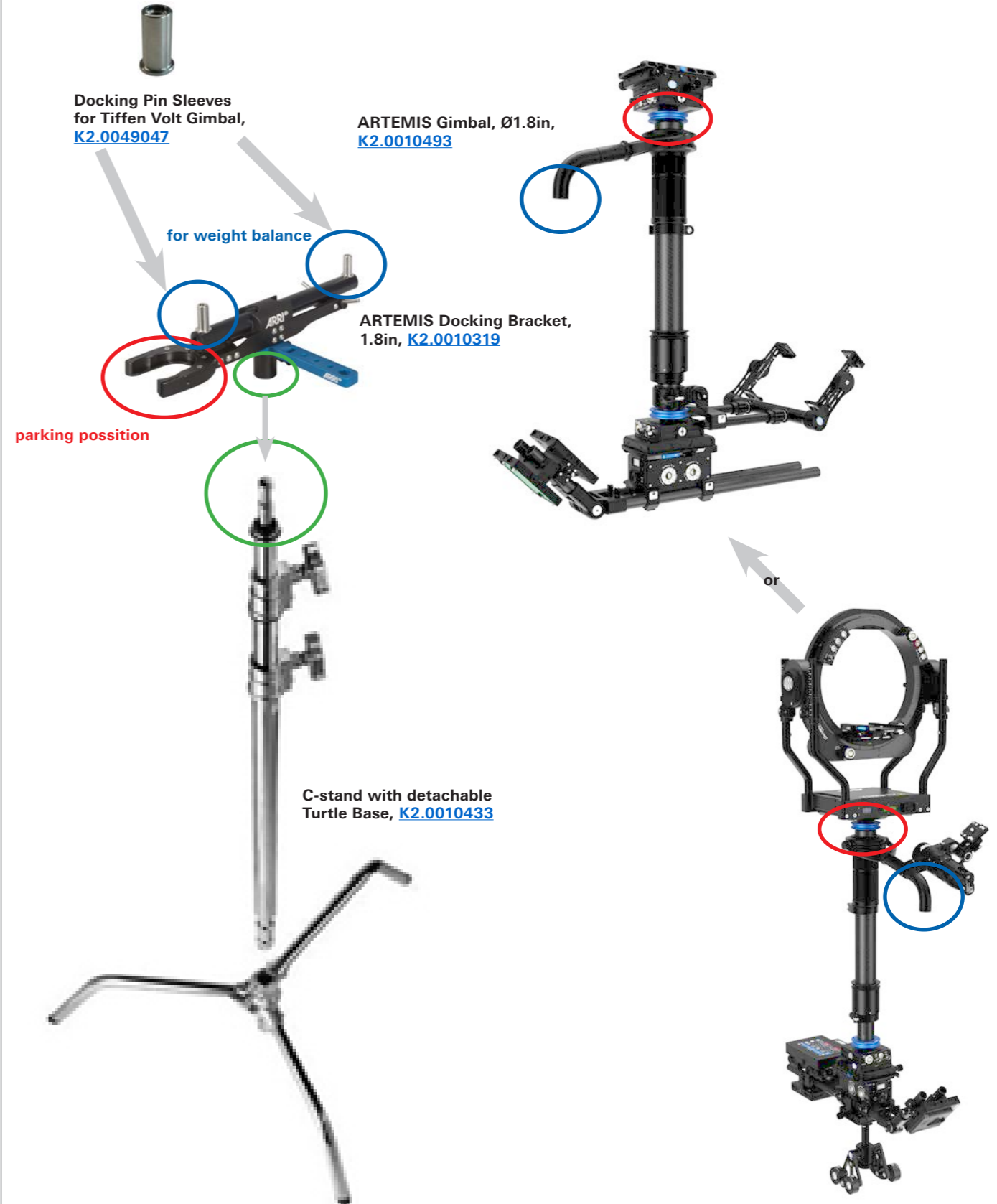

**Docking Pin Sleeves for Tiffen Volt Gimbal**,  
[K2.0049047](#)

**ARTEMIS Gimbal, Ø1.8in**,  
[K2.0010493](#)

for weight balance

**ARTEMIS Docking Bracket, 1.8in**,  
[K2.0010319](#)

parking position

**C-stand with detachable Turtle Base**,  
[K2.0010433](#)

# Plates and Dovetails - ARTEMIS 2 / TRINITY 2 / 360 EVO



Configuration Overview | 8.3.2 / 2024.08

## Plates and Dovetails

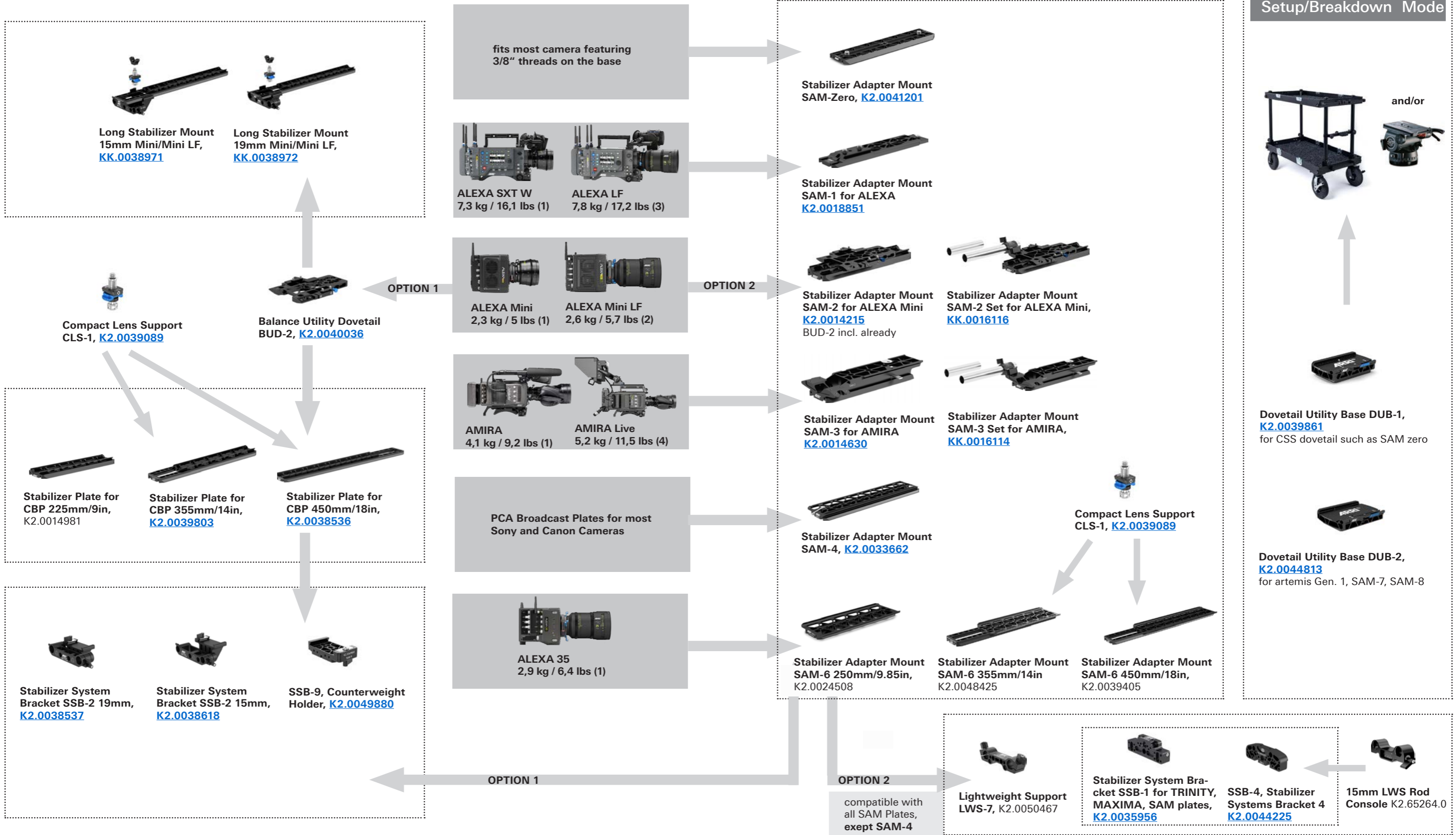

## Setup/Breakdown Mode



# Stabilized Remote Head 360 EVO - Sets



Configuration Overview | 8.4.0 / 2025.02

## Stabilized Remote Head EVO 360



### 360 EVO Basic Set, No Joystick, [KK.0050103](#)

Full-circle rotation on the roll axis. 360-degree rotation on the roll axis, revolving around the optical center of the lens, enables even more creativity for films, dramas, commercials, and music videos. Exceptionally dynamic roll-axis shots can be achieved by mounting the head to a crane, for example, or a cable cam above a live broadcast event.

- includes:
- K2.0049722 1x 360 EVO Stabilized Remote Head
  - K2.0049724 1x RCP-2 EVO Remote Control Panel
  - [K2.0041201](#) 1x Stabilizer Adapter Mount SAM-Zero
  - [K2.0039443](#) 1x Cam Pwr Gen.2, ALEXA 35, Mini, AMIRA, 24 V, 8-pin
  - [K2.0039448](#) 1x Cam Pwr Gen.2, 4-pin XLR, 12 V
  - [K2.0041984](#) 1x 12G HD SDI BNC Cable, 0,63m/25in
  - [K2.0019298](#) 1x SRH Mitchell Mount, Metric
  - [K2.0019302](#) 1x SRH FS CAN Bus Cable, 10m/32.8ft
  - [K2.0019306](#) 1x SRH High-Capacity Battery Power Cable, 12V/24V, 0.5m/1.64ft
  - [K2.0021427](#) 1x SRH High-Capacity Battery Power Cable 24V, 3-pin XLR, 10m/33ft
  - [K2.0021428](#) 1x SRH High-Capacity Battery Power Cable 12V, 4-pin XLR, 10m/33ft
  - [K2.0038756](#) 1x Wrench for SRH Castle Nut, Mitchell Mount
  - K2.0037206 2x 3/8in-16 Camera Screw
  - K2.0037205 1x 90° angled Hex Key 4mm
  - K2.0037207 1x Zip bag for tools
  - [K2.0042681](#) 1x TRH-2 Ring Main Cable, Long, 0,75m/29.5in
  - [K2.0049726](#) 1x Case 360 EVO Stabilized Remote Head

**NOTE**  
The 360 EVO BASIC set does NOT include a joystick!  
To complete the initial order, at least one of the mandatory joystick sets must be ordered.  
Standard Joystick for SRH Remote Control Panel, RCP-2 ([K2.0039880](#)) Microforce Joystick for SRH Remote Control Panel, RCP-2 ([K2.0039882](#)) Broadcast Joystick for SRH Remote Control Panel, RCP-2 ([K2.0039881](#))

## Mandatory Joysticks for RCP-2

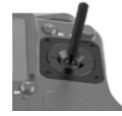

**Standard Joystick for SRH Remote Control Panel,** [K2.0039880](#)



**Broadcast Joystick for SRH Remote Control Panel,** [K2.0039881](#)



**Microforce Joystick for SRH Remote Control Panel,** [K2.0039882](#)



**Focus Knob for SRH Remote Control Panel,** [K2.0019291](#)



**Zoom Rocker for SRH Remote Control Panel,** [K2.0019292](#)



**Additional Joystick for SRH Remote Control Panel, left side,** [K2.0019290](#)



**Focus / Zoom Set for SRH Remote Control Panel,** [K0.0019595](#)



**SRH Tripod Adapter Plate for SRH Remote Control,** [K2.0019293 \\*](#)

## Radio Sets



**ERM-2400 2.4 GHz RXD-TXD Pro Set, SRH,** [KK.0040049](#)



**ERM-2400 Ext 2.4 GHz RXD-TXD Pro Set LCS,** [KK.0040048](#)



**ERM-900 MHz RXD-TXD Pro Set, SRH,** [KK.0040050](#)

For more details see Configuration Overview 8.6.0 & 8.6.1

## Optional Controllers



**DEH-2 Pro Set, Right Zoom Rocker Master Grip, OCU-1,** [K0.0048723](#)

- Includes:
- [K2.0044672](#) 1x DEH-2, Digital Encoder Head 2
  - K2.0020002 1x Operator Control Unit OCU-1 Basic Set
  - K2.0020003 1x OCU-1 Rosette Bracket
  - K2.0009493 1x Master Grip Right Rocker MRR-1
  - K2.0048586 2x Cartoni special pan bar ø20mm
  - K2.0012919 2x Handgrip Pan Bar Adapter 20mm
  - K2.0006752 2x Cable LBUS - LBUS (0.8m/2.6ft)
  - K2.0006753 2x Cable LBUS - LBUS (1.5m/5ft)

**DEH-2 Pro Set, Left Zoom Rocker Master Grip, OCU-1,** [K0.0048724](#)



**DEP-1, Digital Encoder Pedal, Pro Set,** [K0.0039160](#)

- includes:
- K2.0039147 1x DEP-1, Host Pedal
  - K2.0039149 1x DEP-1, Client Pedal
  - K2.0001637 1x Cable RS - RS/PWR IN (0.5m/1.6ft)



**DEH-1 Digital Encoder Head,** [K2.0022594](#)



**DEH-2, Digital Encoder Head 2,** [K2.0044672](#)

## Bracket for Controller



**SSB-7, Stabilizer System Bracket 7, DEH-2 Set,** [KK.0049407](#)

- Special Counterweight Bracket for the DEH-2
- includes:
- K2.0048281 1x Stabilizer System Bracket SSB-7
  - [K2.0043811](#) 2x Single Support Rod 76mm, 3in, Ø19mm
  - K2.0048587 2x Cartoni Counterweights Rod ø22mm, 2x0,5kg

- Recommended accessories:
- BMS-3, Pro Set, V-Mount ([KK.0049408](#))
  - BMS-3, Pro Set, Gold-Mount ([KK.0049409](#))
  - Multicam Monitor bundle VMM-1 & MYS-1 (K0.0039106)



**EJS-1, EJW-1, Controller Set,** [KK.0051502](#)

- includes:
- K2.0049229 1x EJS-1, External Joystick, Broadcast
  - K2.0049230 1x EJW-1, External Jog-Wheels
  - K2.0006750 2x Cable LBUS - LBUS (0.3m/1ft)
  - [K2.0042837](#) 2x CSS Clamp Bridge 52, 19mm
  - K2.0047854 1x NATO Accessory Rail NAR-60
  - K2.0049419 1x NATO Rail Clamp NRC-3



**EJW-1, Controller Set,** [KK.0051102](#)

- includes:
- K2.0049230 1x EJW-1, External Jog-Wheels
  - K2.0006750 1x Cable LBUS - LBUS (0.3m/1ft)
  - [K2.0042837](#) 1x CSS Clamp Bridge 52, 19mm
  - K2.0047854 1x NATO Accessory Rail NAR-60
  - K2.0049419 1x NATO Rail Clamp NRC-3



**DRW-1 Digital Remote Wheel, Single Wheel Set,** [KK.0051504](#)

- includes:
- K2.0051132 1x DRW-1 Mounting Base 2
  - [KK.0021211](#) 1x DRW-1 Digital Remote Wheel, Third Wheel Set
  - [K2.0042837](#) 1x CSS Clamp Bridge 52, 19mm

**DRW-1, Digital Remote Wheel, Single Wheel Set, 160mm,** [KK.0053982](#), includes:

- K2.0019319 1x DRW-1 Module
- K2.0051672 1x Hand Wheel 160 complete
- K2.0019318 1x DRW-1 Modul Mounting Bracket
- K2.0051132 1x DRW-1 Mounting Base 2
- [K2.0042837](#) 1x CSS Clamp Bridge 52, 19mm

**RCP-3, Controller, 19mm Mounting Set,** [KK.0051503](#)

- includes:
- [K2.0049453](#) 1x Mitchell Wedge Lock Set
  - [K2.0050433](#) 1x CSS Mitchell Base Plate
  - [K2.0049885](#) 2x CCB-2, CSS Clamp Bridge-2, 52, 19mm
  - K2.0040791 1x Support Rods 430mm, 16.9in, Ø19mm

\* discontinued - only as long as stock is available

# Stabilized Remote Head 360 EVO - Accessories & Upgrade Sets



Configuration Overview | 8.4.1 / 2025.06

## Balance and Fibration-free Components / Mounting Options Flate Base



**Vibration Isolator for SRH, Gen. 2, Metric, Basic Set,** [KK.0039359](#)

includes:  
K2.0038752 1x Vibration Isolator for SRH, Gen. 2, Metric  
[K2.0024106](#) 1x SRH Mitchell Mount Castle Nut, Metric  
[K2.0038756](#) 1x Wrench for SRH Castle Nut, Mitchell Mount  
[K2.0038758](#) 1x Case for Vibration Isolator for SRH, Gen 2

**Vibration Isolator for SRH, Gen. 2, Imperial, Basic Set,** [KK.0041936](#)

includes:  
K2.0041912 1x Vibration Isolator for SRH, Gen. 2, imperial  
[K2.0041922](#) 1x SRH Mitchell Mount Castle Nut, Imperial  
[K2.0038756](#) 1x Wrench for SRH Castle Nut, Mitchell Mount  
[K2.0038758](#) 1x Case for Vibration Isolator for SRH, Gen 2



**SRH Modular Low Mount Rack,** [K2.0024658](#) \*

\* discontinued - only as long as stock is available



**SRH Mitchell Mount Castle Nut,** metric, [K2.0024106](#)  
imperial, [K2.0041922](#)



**Wrench for SRH Castle Nut, Mitchell Mount,** [K2.0038756](#)



**SRH Mitchell Mount Collar, 45mm / 1.77in,** [K2.0019297](#)



**SRH Mitchell Mount Collar, 40mm / 1.57in, Metric,** [K2.0024108](#)



**Mitchell Wedge Lock Set** [K2.0049453](#)



**CSS Euro Mount** [K2.0010426](#) \*



**SRH Mitchell Mount, Metric** [K2.0019298](#)



**CSS Mitchell Base Plate,** [K2.0050433](#)

## Top-Stabilization in Ring



**Top Attachment Bracket TAB-1,** [K2.0041117](#)



**TAB-1-Extension** [K2.0049835](#)



**SSB-4, Stabilizer Systems Bracket 4** [K2.0044225](#)

## Power / Battery

for quick installation of the battery mount on 19 mm rods



**BMS-3, Pro Set, V-Mount,** [KK.0049408](#)

includes:  
K2.0048655 1x BMS-3, Battery Mounting Base naked  
[K2.0040286](#) 1x V-Mount for BMS-1 / BMS-2  
[K2.0042837](#) 1x CSS Clamp Bridge 52, 19mm  
[K2.0036902](#) 1x ERM D-Tap Pwr Cable, 0B Lemo 2-pin to D-Tap, 1m/3.2ft  
[K2.0021422](#) 1x 12V Battery Power Cable, D-Tab, 4-pin XLR, 1,5m/5ft



**BMS-3, Pro Set, Gold-Mount,** [KK.0049409](#)

includes:  
K2.0048655 1x BMS-3, Battery Mounting Base naked  
[K2.0040285](#) 1x Gold Mount for BMS-1 / BMS-2  
[K2.0042837](#) 1x CSS Clamp Bridge 52, 19mm  
[K2.0036902](#) 1x ERM D-Tap Pwr Cable, 0B Lemo 2-pin to D-Tap, 1m/3.2ft  
[K2.0021422](#) 1x 12V Battery Power Cable, D-Tab, 4-pin XLR, 1,5m/5ft

## Network Communication



**CSS IP-Box Set, TX / RX,** [K2.0052050](#)

**RCP-3, FS Can Bus Cable, 25cm/10in,** [K2.0043883](#)  
**SRH FS CAN Bus Cable, 10m/32.8ft,** [K2.0019302](#)  
**SRH FS CAN Bus Coupler, 0.2m/0.65ft,** [K2.0019300](#)  
**Monitor Power, 12V, Lemo 0B 2-pin to 0B 2-pin,** [K2.0041723](#)  
**ERM D-Tap Pwr Cable, 0B Lemo 2-pin to D-Tap, 1m/3.2ft,** [K2.0036902](#)

## Cable



**SRH FS CAN Bus Cable, 25m/82ft,** [K2.0019301](#)  
**SRH FS CAN Bus Cable, 10m/32.8ft,** [K2.0019302](#)  
**SRH FS CAN Bus Cable, 1m/3.2ft,** [K2.0033762](#)



**SRH FS CAN Bus Coupler, 0.2m/0.65ft,** [K2.0019300](#)



**SRH High-Capacity Battery Power Cable 24V, 3-pin XLR, 10m/33ft,** [K2.0021427](#)

**SRH High Capacity Battery Power Cable 12V, 4pin XLR, 10m/33ft,** [K2.0021428](#)

**SRH High Capacity Battery Power Cable 24V, 3pin XLR, 20m/66ft,** [K2.0021429](#)

**SRH High Capacity Battery Power Cable 12V, 4pin XLR, 20m/66ft,** [K2.0021430](#)

**SRH High-Capacity Battery Power Cable, 12V/24V, 0.5m/1.64ft,** [K2.0019306](#)

## CSS Accessories



**Counterweight Set, 150 g, 300 g,** [KK.0033710](#)



**SRH Side Accessory Mounting Bracket,** [K2.0019296](#) \*



**SRH Side Brackets for Remote Control Panel,** [K2.0019289](#) \*



**SRH Tripod Adapter Plate for SRH Remote Control,** [K2.0019293](#) \*



**SRH Rod Support Set,** [K2.0033426](#)



**SRH Top Support Bracket,** [K2.0019727](#)



**SSB-4, Stabilizer Systems Bracket 4,** [K2.0044225](#)



**RCP-2 Rod Mounting Adapter, 19mm, cmpl.,** [KK.0052698](#)

includes:  
K2.0052699 1x RCP-2-Rod Mounting Adapter, incl. Screws  
[K2.0042837](#) 2x CSS Clamp Bridge 52, 19mm

\* discontinued - only as long as stock is available

## Cable for large Camera Setup



**TRH-2 Ring Main Cable, Standard, 0,65m/25.5in,** [K2.0042631](#)

**TRH-2 Ring Main Cable, Long, 0,75m/29.5in,** [K2.0042681](#)

## Protection



**Case 360 EVO Stabilized Remote Head,** [K2.0049726](#)



**Rain Cover 360 EVO & SRH-3 & SRH-360,** [K2.0043054](#)



**Case for DEH-2,** [K2.0048588](#)



**Case for Vibration Isolator for SRH, Gen 2,** [K2.0038758](#)



# 360 EVO Stabilized Remote Head - Sample Configuration Live Production



Configuration Overview | 8.4.3 / 2025.06

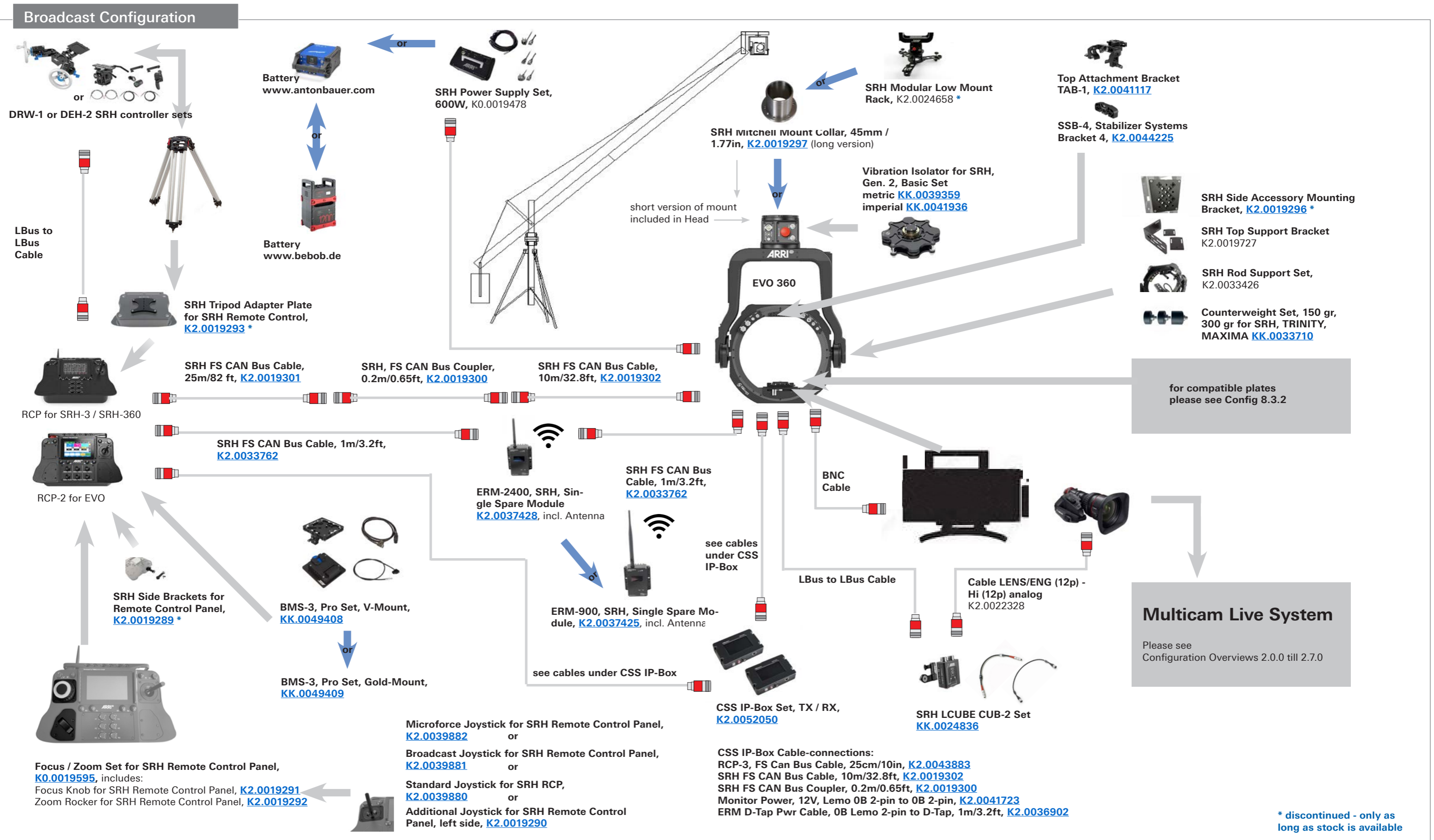

# 360 EVO Stabilized Remote Head - Setup Cine Style Network



Configuration Overview | 8.4.4 / 2025.09

## ARRI Cameras with LBUS

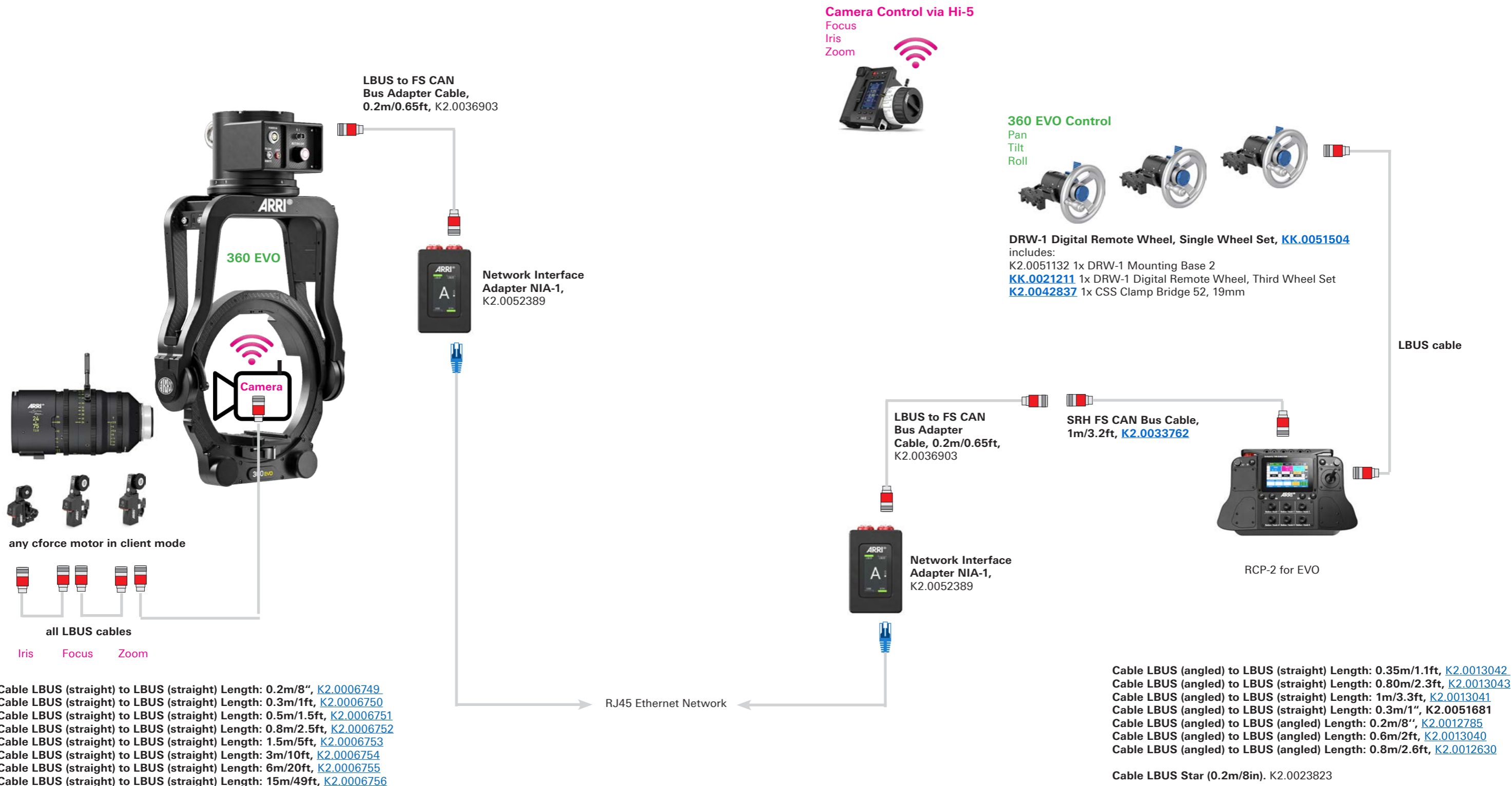

# External Radio Module ERM - TRINITY 2 / 360 EVO



Configuration Overview | 8.5.0 / 2024.11

## TRINITY 2, EVO 360 - for tilt/pan/roll axis of the head



The external radio module offers reliable wireless communication over 2.4 GHz between the remote control and the Stabilized Remote Head 360 EVO and SRH-3 and SRH-360. The range of up to 1000 m/3280 ft. is based on so-called channel hopping.

### ERM-2400 2.4 GHz RXD-TXD Basic Set, SRH, [KK.0040049](#)

includes:  
[K2.0037428](#) 2x ERM-2400, SRH, Single Module  
[K2.0033763](#) 2x ERM-2400 Rubber Duck Antenna  
[K2.0033762](#) 2x SRH FS CAN Bus Cable, 1m/3.2ft  
[K2.0033761](#) 1x ERM Power Cable, ERM-2400 & ERM-900

Range:  
 Up to 1000 meter / 3280 ft.



The external radio module offers reliable wireless communication over 900 MHz between the remote control and the Stabilized Remote Head 360 EVO and SRH-3 and SRH-360. The range of up to 3000 m/6560 ft. is based on so-called channel hopping.

### ERM-900 MHz RXD-TXD Basic Set, SRH, [KK.0040050](#)

includes:  
[K2.0037425](#) 2x ERM-900, SRH, Single Module  
[K2.0033765](#) 2x ERM-900 Rubber Duck Antenna  
[K2.0033762](#) 2x SRH FS CAN Bus Cable, 1m/3.2ft  
[K2.0033761](#) 1x ERM Power Cable, ERM-2400 & ERM-900

Range:  
 Up to 3000 meter / 6560 ft

certified only for use in USA and Canada



ERM-2400 Rubber Duck Antenna, [K2.0033763](#)



ERM-2400, SRH, Single Spare Module [K2.0037428](#), incl. Antenna



ERM-900 Rubber Duck Antenna, [K2.0033765](#)



ERM-900, SRH, Single Spare Module, [K2.0037425](#), incl. Antenna

## Wireless LCS/LBUS/EXT Connection



An ERM-2400 LCS set of radio modules basically extends an LCS/LBUS/EXT (CAN bus) cable connection over air. As such, it can connect ARRI and motion hand units to cameras and motor controllers and they behave as if they were hardwired, but with an exceptionally great wireless range (up to 1,000 m/3,280 ft).

### ERM-2400 Ext 2.4 GHz RXD-TXD Pro Set LCS, [KK.0040048](#)

[K2.0037440](#) 2x ERM-2400, LCS, Single Module  
[K2.0033763](#) 2x ERM-2400 Rubber Duck Antenna  
[K2.0036900](#) 2x ERM LCS to FS CAN Bus Adapter Cable, 0.2m/0.65ft  
[K2.0036903](#) 2x ERM LBUS to FS CAN Bus Adapter Cable, 0.2m/0.65ft  
[K2.0036901](#) 1x ERM EXT. to FS CAN Bus Adapter Cable, 0.2m/0.65ft  
[K2.0036902](#) 1x ERM D-Tap Pwr Cable, 0B Lemo 2pin to D-Tap, 1m/3.2ft  
[K2.0033762](#) 2x SRH FS CAN Bus Cable, 1m/3.2ft

Note:  
 The basic set is only supplied with adapter cables.

Recommended and required optional extension cables:

- SRH FS CAN Bus Cable, 10m/32.8ft [K2.0019302](#)
- SRH FS CAN Bus Cable, 25m/82ft [K2.0019301](#)
- SRH FS CAN Bus Coupler, 0.2m/0.65ft [K2.0019300](#)



ERM-2400 Rubber Duck Antenna, [K2.0033763](#)



ERM-2400, LCS, Single Spare Module, [K2.0037440](#), incl. Antenna coupling through ARRI Service

## TRINITY 2 - RCP communication



TRINITY RF-2400 Radio Set, [K0.0044373](#)



TRINITY RAT-1 Radio Adapter Set, [K0.0047466](#)

## Cables



ERM LCS to FS CAN Bus Adapter Cable 0.2m/0.65ft [K2.0036900](#)



ERM LBUS to FS CAN Bus Adapter Cable, 0.2m/0.65ft [K2.0036903](#)



ERM EXT. to FS CAN Bus Adapter Cable, 0.2m/0.65ft [K2.0036901](#)



ERM D-Tap Pwr Cable, 0B Lemo 2-pin to D-Tap, 1m/3.2ft, [K2.0036902](#)



Required optional extension cables:  
 SRH FS CAN Bus Cable, 0,3m/0.98ft, [K2.0037788](#)  
 SRH FS CAN Bus Cable, 1m/3.2ft, [K2.0033762](#)  
 SRH FS CAN Bus Cable, 5m/16.4ft, [K2.0037701](#)  
 SRH FS CAN Bus Cable, 10m/32.8ft, [K2.0019302](#)  
 SRH FS CAN Bus Cable, 25m/82ft, [K2.0019301](#)

## LCS Configuration Samples

For Configuration Sample with the Lens Control System please also see [Configuration Overview 4.7.0 till 4.7.2](#)

## EVO Configuration Samples

For Configuration Sample with the EVO 360, SRH-360 & SRH-3 System please also see [Configuration Overview 8.4.2 & 8.4.3 & 8.5.1](#)

## Mounting Bracket ERM



Rod Mounting Bracket RMB-3, [K2.0006186](#)

# External Radio Module ERM - Sample Configurations for CSS



Configuration Overview | 8.5.1 / 2024.08

## Stabilized Remote Head with ERM SRH

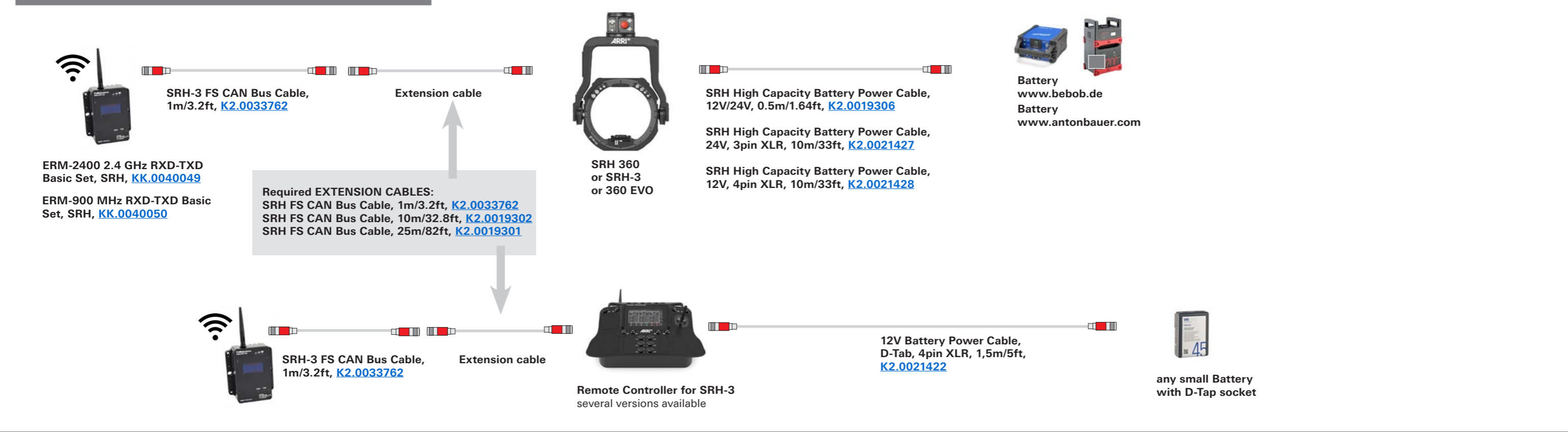

## Digital Encoder Head or Wheels with ERM LCS

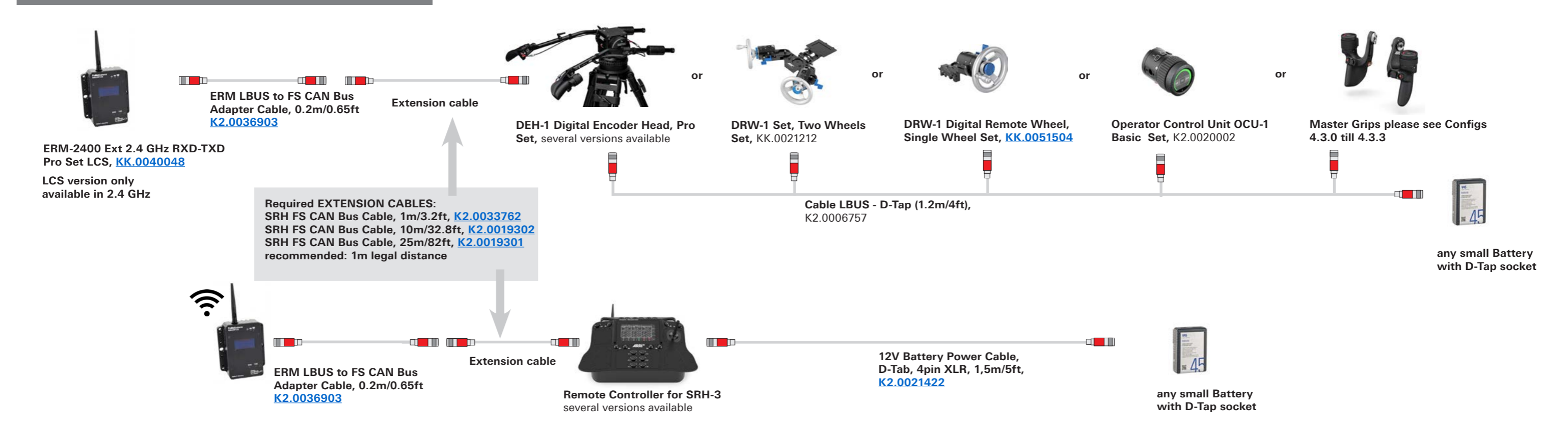

# Stabilizer System - Cable Guide 1



Configuration Overview | 8.6.0 / 2024.11

Item Number	Cable Name	Supported Cameras	Artemis 1	Artemis 2	TRINITY 1	TRINITY 2	360 EVO
<a href="#">K2.0039443</a>	Cam Pwr Gen.2, ALEXA 35, Mini, AMIRA, 24 V, 8-pin	Tally Sensor Cable can be used with the first and second generation of the Tally system.	X	✓	X	✓	✓
<a href="#">K2.0039446</a>	Cam Pwr Gen. 2, Alexa LF, 24V, 2-pin Fischer	24V high-capacity camera power cable. Lemo 2B 7-pin to Fischer 2-pin, 0.7m / 2.3ft	X	✓	X	✓	✓
<a href="#">K2.0039447</a>	Cam Pwr Gen.2, ALEXA Mini, AMIRA, 12 V, 8-pin	12V high-capacity camera power cable. Lemo 2B 7-pin to Lemo 2B 8-pin, 0.7m / 2.3ft	X	✓	X	✓	✓
<a href="#">K2.0040329</a>	Cam Pwr Gen. 2, 4 pin XLR, 12V, 90° elbow	12V high-capacity camera power cable. Lemo 2B 7-pin to XLR 4-pin, 90° elbow, 0.7m / 2.3ft	X	✓	X	✓	✓
<a href="#">K2.0039448</a>	Cam Pwr Gen.2, 4-pin XLR, 12 V	12V high-capacity camera power cable. Lemo 2B 7-pin to XLR 4-pin, 0.7m / 2.3ft	X	✓	X	✓	✓
<a href="#">K2.0039449</a>	Cam Pwr Gen.2, RED Monstro, 12 V	12V high-capacity camera power cable. Lemo 2B 7-pin to Lemo 1B 6-pin, 0.7m / 2.3ft	X	✓	X	✓	✓
<a href="#">K2.0039450</a>	Cam Pwr Gen.2, RED Ranger, 24 V	24V high-capacity camera power cable. Lemo 2B 7-pin to Lemo 2B 4-pin, 0.7m / 2.3ft	X	✓	X	✓	✓
<a href="#">K2.0039451</a>	Cam Pwr Gen.2, SONY Venice, 4-pin XLR, 24 V	24V high-capacity camera power cable. Lemo 2B 7-pin to XLR 4-pin, 0.7m / 2.3ft	X	✓	X	✓	✓
<a href="#">K2.0010470</a>	Cam Power, Cine, 12 V, XLR, HiCap	12 V XLR high-capacity camera power cable, Lemo 1B 4-pin to XLR 4-pin, for video cameras, ARRIFLEX 16SR I, ARRI 16SR II, Aaton and other devices using a 4-pin XLR socket. LEMO 4-pin, 12V, high capacity	✓	✓	✓	✓	X
<a href="#">K2.0037771</a>	Power Cable, BHM-2 to TST, 12V, 24V, Bat. Data	High-capacity 12 V/24 V power cable to connect the Battery Hanger Module with the Top Stage or Bottom Stage Gen.2. Lemo 2B 7-pin to Lemo 2B 7-pin, 12V/24V	X	not for Artemis 2 Live ✓	X	✓	X
<a href="#">K2.0048481</a>	BHM-2 to TRH-2 Ext. Pwr, 7pin, 2m / 6.5ft	This external power cord allows the TRINITY 2 head to be powered when used as a standalone stabilizer mounted on the MSP-1 ( <a href="#">K2.0015385</a> ) through the Battery Hanger Module (BHM-2), which was also detached from the rig. Lemo 2B 7pin - Length: 2m / 6.5ft	X	✓	X	✓	X

# Stabilizer System - Cable Guide 2



## Configuration Overview | 8.6.1 / 2024.08

Item Number	Cable Name	Supported Cameras	Artemis 1	Artemis 2	TRINITY 1	TRINITY 2	360 EVO
<a href="#">K2.0010546</a>	Monitor Power, 12V, Lemo 0B 2-pin	12V monitor power cable. Lemo 0B 2-pin to XLR 4-pin, 12V.	✓	✓	✓	✓	✓
<a href="#">K2.0041723</a>	Monitor Power, 12V, Lemo 0B 2-pin to 0B 2-pin	Short 12 V power cable to power a second Transvideo Starlite or SmallHD monitor from the Tally System Gen.2 host module. Lemo 0B 2-pin to Lemo 0B 2-pin, 12V	✓	✓	✓	✓	✓
<a href="#">K2.0021422</a>	12V Battery Power Cable, D-Tab, 4-pin XLR, 1,5m/5ft	12 V power cable to power the 360 EVO, SRH-3 and SRH-360 remote control panel, or a monitor via D-Tab. D-Tab to 4-pin XLR, 1,5m/5ft, 12V. For Remote Control Panel (RCP-2) of the 360 EVO, SRH-3 and SRH-360	✓	✓	✓	✓	✓
<a href="#">K2.0038998</a>	MTG Monitor Pwr, Lemo 0B, 2-pin	Power cable to power a Transvideo Starlight, or SmallHD 503 monitor from the Master Grip TRINITY 2. Lemo 0B 4-pin to Lemo 0B 2-pin, 24V. For MGT-1, MGT-2, TRINITY 2	✗	✗	✓ after LBUS upgrade	✓	✗
<a href="#">K2.0038999</a>	MTG Monitor Pwr, Lemo 0B, 5-pin	Power cable to power a ARRI Starlite monitor from the Master Grip TRINITY 2. Lemo 0B 4-pin to Lemo 0B 5-pin, 24V. For MGT-1, MGT-2, TRINITY 2	✗	✗	✓ after LBUS upgrade	✓	✗
<a href="#">K2.0043861</a>	TRINITY 2 Joystick Cable, 75cm/29.5in	Flexible joystick cable to connect Master Grip TRINITY with the TRINITY 2 head. Lemo 0B 4-pin to Lemo 0B 4-pin, 24V, 75cm/29.5in	✗	✗	✓ after LBUS upgrade	✓	✗
<a href="#">K2.0043975</a>	TRINITY 2 Joystick Cable, 1,25m/49in	Flexible joystick cable to connect the Master Grip TRINITY to the TRINITY 2 head when the rig is fully extended or when using a Super Post. Lemo 0B 4-pin to Lemo 0B 4-pin, 24V, 125cm/49in	✗	✗	✓ after LBUS upgrade	✓	✗
<a href="#">K2.0043884</a>	TRINITY 2 analog Joystick Cable	Analog joystick cable to connect the analog TRINITY Gen. 1 Joystick with TRINITY 2. Lemo 1B 8-pin to Lemo 0B 7-pin, no video, 12V	✗	✗	✓	✓	✗
<a href="#">K2.0014805</a>	TRINITY Gen. 1 Joystick Main Cable	TRINITY Gen. 1 Joystick Main Cable including the BNC-SMB Cable. Lemo 1B 8-pin to Lemo 0B 7-pin, 12V	✗	✗	✓	✗	✗
<a href="#">K2.0014801</a>	Joystick Pwr. Cable for ARRI Starlite	Power cable to connect the ARRI Starlight monitor to the TRINITY Gen.1 Joystick Monitor Mount. Lemo 0B 5-pin 90° elbow to Lemo 0B 5-pin, 12V	✗	✗	✓	✗	✗
<a href="#">K2.0014803</a>	Joystick Pwr. Cable for Starlite	Power cable to connect the Transvideo Starlight, or Small HD 503 monitor to the TRINITY Gen. 1 Joystick Monitor Mount. Lemo 0B 5-pin 90° elbow to Lemo 0B 2-pin, 12V	✗	✗	✓	✗	✗

# Stabilizer System - Cable Guide 3



## Configuration Overview | 8.6.2 / 2024.08

Item Number	Cable Name	Supported Cameras	Artemis 1	Artemis 2	TRINITY 1	TRINITY 2	360 EVO
<a href="#">K2.0037459</a>	Volt Pwr Cable 0B 3-pin to 0S 4-pin 0.3 m/0.9ft	Power cable to power the Volt Control Box from the artemis Cine Gen.1 top stage. Lemo 0B 3-pin - Lemo 0S 4-pin, Length: 0.3m/0.9ft, 12V	✓	✗	✗	✗	✗
<a href="#">K2.0037457</a>	Volt Pwr Cable 0B 3-pin to RS 3-pin 0.3 m/0.9ft	Power cable to power the Volt™ Control Box from the ARTEMIS Gen. 2 top stage. Lemo 0B 3-pin - Fischer 3-pin, 12v, Length: 0.3m/0.9ft	✗	✓	✗	✗	✗
<a href="#">K2.0037460</a>	Volt Pwr Cable 0B 3-pin to 0B 2-pin, 0.4 m/1.3ft	Power cable to power the Volt™ Control Box from the ARTEMIS top stage. Lemo 0B 3-pin - Lemo 0B 2-pin, 12V, Length: 0.4m/1.3ft	✗	✓	✗	✗	✗
<a href="#">K2.0043883</a>	RCP-3, FS Can Bus Cable, 25cm/10in	Power and data cable to connect the RCP-3 remote control to the TRINITY2 system. Fischer 4-pin to Fischer 4-pin, 12v, 25cm/10in	✗	✗	✗	✓	✗
<a href="#">K2.0042631</a>	TRH-2 Ring Main Cable, Standard, 0,65m/25.5in	Flexible standard main cable to connect the outer ring of the TRINITY 2 to the inner ring. High-capacity 12V/24V, Data, 1 x 12G Video, LBUS, Can Bus, tally Length: 0,65m/25,5in	✗	✗	✗	✓	✓
<a href="#">K2.0042681</a>	TRH-2 Ring Main Cable, Long, 0,75m/29.5in	Extra long flexible main cable to connect the outer ring of the TRINITY 2 to the inner ring. High-capacity 12v/24V, Data, 1 x 12G video, LBUS, Can Bus, tally Length: 0,65m/26in	✗	✗	✗	✓	✓
<a href="#">K2.0040332</a>	Post Main Cable, 3B, 16pin	Main cable for ARTEMIS 2 and TRINITY 2. High-capacity 12V/24V, Data, 2 x 12G video, LBUS, Can Bus, tally Lemo 3B 16-pin to Lemo 3B 16-pin	✗	✓	✗	✓	✗
<a href="#">K2.0041161</a>	Super Post Main Cable, 3B, 16-pin	Super Post main cable for ARTEMIS 2 and TRINITY 2. Lemo 3B 16-pin to Lemo 3B 16-pin High-capacity 12V/24V, 2 x 12G video, LBUS, Can Bus, tally	✗	✓	✗	✓	✗
<a href="#">K2.0010552</a>	Post Main Cable, 3B, 10-pin	Main cable for artemis Gen.1 and TRINITY Gen.1. Lemo 3B 10-pin to Lemo 3B 10-pin High-capacity 12V / 24V, 2x 4G Video, Tally	✓	✗	✓	✗	✗
<a href="#">K2.0041993</a>	Super Post Main Cable, 3B, 10-pin	Super Post main cable for artemis Gen.1 and TRINITY Gen.1. High-capacity 12V/24V, 2x 4G video, tally Lemo 3B 10-pin to Lemo 3B 1-0pin	✓	✗	✓	✗	✗
K2.0043669	Post Main Cable, TRINITY Live	Special main cable for the TRINITY Live Gen. 1 High-capacity 12V, Data, 2 x 4G video, tally Lemo 3B 10-pin to Lemo 3B 10-pin	✗	✗	✓	✗	✗
K2.0050244	12V/24V TRINIY 1 Live Power Cable		✗	✗	✓	✗	✗
<a href="#">K2.0050770</a>	Communication Cable, TRINITY 2 Pan Axis		✗	✗	✗	✓	✗
						PAN Axis only	

# Stabilizer System - Cable Guide 4



## Configuration Overview | 8.6.3 / 2024.08

Item Number	Cable Name	Supported Cameras	Artemis 1	Artemis 2	TRINITY 1	TRINITY 2	360 EVO
<a href="#">K0.0021437</a>	SRH High Capacity Battery Power Cable Set, 12V/24V, 20m/66ft	12V/24V high-capacity battery power cable set to connect a 12V/24V block battery to the 360 EVO, SRH-3 and SRH-360. includes: <a href="#">K2.0019306</a> 1x SRH High-Capacity Battery Power Cable, 12V/24V, 0.5m/1.64ft, <a href="#">K2.0021429</a> 1x SRH High-Capacity Battery Power Cable 24	X	X	X	✓ PAN Axis only	✓
<a href="#">K0.0021438</a>	SRH High-Capacity Battery Power Cable Set 12V/24V, 10m/33ft.	„12V/24V high-capacity battery power cable set to connect a 12V/24V block battery to the 360 EVO, SRH-3 and SRH-360. includes: <a href="#">K2.0019306</a> 1x SRH High-Capacity Battery Power Cable, 12V/24V, 0.5m/1.64ft, <a href="#">K2.0021427</a> 1x SRH High-Capacity Battery Power Cable 24	X	X	X	✓ PAN Axis only	✓
<a href="#">K2.0019306</a>	SRH High-Capacity Battery Power Cable, 12V/24V, 0.5m/1.64ft	Power cable to power the Stabilized Remote Head 360 EVO, SRH-3 and SRH-360 with 12 V and 24 V power from a high-capacity battery providing 12 V and 24 V power. 12 V 4-pin XLR and 24 V 3-pin XLR, Length: 0.5 m/1.64ft	X	X	X	✓ PAN Axis only	✓
<a href="#">K2.0021430</a>	SRH High Capacity Battery Power Cable 12V, 4-pin XLR, 20m/66ft	12V high-capacity extension cable to connect a block battery with the SRH High-Capacity Battery Power Cable, 12V/24V, 0.5m/1.64ft ( <a href="#">K2.0019306</a> ), 12V high-capacity, 4-pin XLR, Length: 20m/66ft	X	X	X	✓ PAN Axis only	✓
<a href="#">K2.0021429</a>	SRH High-Capacity Battery Power Cable 24V, 3-pin XLR, 20m/66ft	24V high-capacity extension cable to connect a block battery with the SRH High-Capacity Battery Power Cable, 12V/24V, 0.5m/1.64ft ( <a href="#">K2.0019306</a> ), 24V high-capacity, 3-pin XLR, Length: 20m/66ft	X	X	X	✓ PAN Axis only	✓
<a href="#">K2.0021428</a>	SRH High-Capacity Battery Power Cable 12V, 4-pin XLR, 10m/33ft	12V high-capacity extension cable to connect a block battery with the SRH High-Capacity Battery Power Cable, 12V/24V, 0.5m/1.64ft ( <a href="#">K2.0019306</a> ), 12V high-capacity, 4-pin XLR, Length: 10m/33ft	X	X	X	✓ PAN Axis only	✓
<a href="#">K2.0021427</a>	SRH High-Capacity Battery Power Cable 24V, 3-pin XLR, 10m/33ft	24V high-capacity extension cable to connect a block battery with the SRH High Capacity Battery Power Cable, 12V/24V, 0.5m/1.64ft ( <a href="#">K2.0019306</a> ). 24V high-capacity, 3-pin XLR, Length: 10m/33ft	X	X	X	✓ PAN Axis only	✓
<a href="#">K2.0037788</a>	SRH FS CAN Bus Cable, 0,3m/0,98ft	Extension cable to connect the SRH remote control panel and the SRH remote head. Extension cable to connect the ERM-2400 (2.4GHz) K2.0033757 and ERM-900 (900 MHz) K2.0033758 to the SRH remote control panel and remote head. Extension cable to connect the ERM-LCS to the WCU-4, SXU-1, EXT and LBUS compatible products. Length: 0,3m/0,98ft	X	X	X	✓	✓
<a href="#">K2.0033762</a>	SRH FS CAN Bus Cable, 1m/3.2ft	Extension cable to connect the SRH remote control panel and the SRH remote head. Extension cable to connect the ERM-2400 (2.4GHz) K2.0033757 and ERM-900 (900 MHz) K2.0033758 to the SRH remote control panel and remote head. Extension cable to connect the ERM-LCS to the WCU-4, SXU-1, EXT and LBUS compatible products. Length: 1m/3.2ft	X	X	X	✓	✓
<a href="#">K2.0037701</a>	SRH FS CAN Bus Cable, 5m/16.4ft	Extension cable to connect the SRH remote control panel and the SRH remote head. Extension cable to connect the ERM-2400 (2.4GHz) K2.0033757 and ERM-900 (900 MHz) K2.0033758 to the SRH remote control panel and remote head. Extension cable to connect the ERM-LCS to the WCU-4, SXU-1, EXT and LBUS compatible products. Length: 5m/16.4ft	X	X	X	✓	✓
<a href="#">K2.0019302</a>	SRH FS CAN Bus Cable, 10m/32.8ft	Extension cable to connect the SRH remote control panel and the SRH remote head. Extension cable to connect the ERM-2400 (2.4GHz) K2.0033757 and ERM-900 (900 MHz) K2.0033758 to the SRH remote control panel and remote head. Extension cable to connect the ERM-LCS to the WCU-4, SXU-1, EXT and LBUS compatible products. Length: 10m/32.8ft	X	X	X	✓	✓
<a href="#">K2.0019301</a>	SRH FS CAN Bus Cable, 25m/82ft	Extension cable to connect the SRH remote control panel and the SRH remote head. Extension cable to connect the ERM-2400 (2.4GHz) K2.0033757 and ERM-900 (900 MHz) K2.0033758 to the SRH remote control panel and remote head. Extension cable to connect the ERM-LCS to the WCU-4, SXU-1, EXT and LBUS compatible products. Length: 25m/82ft	X	X	X	✓	✓
<a href="#">K2.0019300</a>	SRH FS CAN Bus Coupler, 0.2m/0.65ft	Coupler to extend SRH FS CAN Bus, Length: 0.2m/0.65ft	X	X	X	✓	✓

# Stabilizer System - Cable Guide 5



## Configuration Overview | 8.6.4 / 2024.08

Item Number	Cable Name	Supported Cameras	Artemis 1	Artemis 2	TRINITY 1	TRINITY 2	360 EVO
<a href="#">K2.0019303</a>	SRH Power Supply Power and Data Cable, 12V/24V, 20m/65.6ft	Power and data cable to power the Stabilized Remote Head 360 EVO, SRH-3 and SRH360 from the 600 W SRH Power Supply K0.0019478 with 12 V and 24 V. 12V/24V high-capacity camera power, plus FS CAN bus. Length: 20m/65.6ft	X	X	X	✓ PAN Axis only	✓
<a href="#">K2.0033761</a>	ERM Power Cable, ERM-2400 & ERM-900	Spare ERM Power Cable for ERM-2400 & ERM-900 Length: 30cm / 11.8in"	X	X	X	✓	✓
<a href="#">K2.0036900</a>	ERM LCS to FS CAN Bus Adapter Cable, 0.2m/0.65ft	Adapter cable to connect the ERM LCS to the WCU-4, SXU-1 UMC-4 and ALEXA Plus camera via the LCS socket.	X	X	X	✓	✓
<a href="#">K2.0036903</a>	ERM LBUS to FS CAN Bus Adapter Cable, 0.2m/0.65ft	Adapter cable to connect the ERM LCS to Master Grips, OCU-1, DRW-1 and DEH-1 via the LBUS socket	X	X	X	✓	✓
<a href="#">K2.0036901</a>	ERM EXT. to FS CAN Bus Adapter Cable, 0.2m/0.65ft	Adapter cable to connect the ERM LCS to ALEXA Mini, ALEXA Mini LF and Amira via the EXT. socket.	X	X	X	✓	✓
<a href="#">K2.0036902</a>	ERM D-Tap Pwr Cable, 0B Lemo 2-pin to D-Tap, 1m/3.2ft	Power cable D-Tap to 2-pin Lemo 0B. Length: 1m/3.2ft	X	X	X	✓	✓
<a href="#">K2.0041984</a>	12G HD SDI BNC Cable, 0,63m/25in	12G HD SDI BNC Cable, Length: 0,63m/25in	✓	✓	✓	✓	✓
<a href="#">K2.0044234</a>	12G HD SDI BNC Cable, 0,84m/33in	12G HD SDI BNC Cable, Length: 0,84m/33in	✓	✓	✓	✓	✓
<a href="#">K2.0051086</a>	12G HD SDI BNC Cable, 1,3m/51,2in	12G HD SDI BNC Cable, Length: 0,84m/33in	✓	✓	✓	✓	✓
<a href="#">K2.0014804</a>	TRINITY BNC Cable for Joystick Main Cable	Spare BNC-SMB cable for the TRINITY Joystick Main Cable	X	X	✓	X	X
<a href="#">K2.0010482</a>	Tally Sensor Cable, Gen.1 & 2	Tally Sensor Cable can be used with the first and second generation of the Tally system. Lemo 0S 4pin Length: 0,55m / 1.80 ft	✓	✓	✓	✓	X
<a href="#">K2.0047301</a>	Tally Gen. 2 Cable CCP Live	Power / Tally cable that connects the Tally host module to CCP Live. Lemo 0S 4pin to 0S 4pin Length: 0,55m / 1.80 ft	✓	✓	✓	✓	X



## Configuration Overview | 9.1.0 / 2025.03

### ARRISCAN XT incl. Wet Gate



**ARRISCAN XT Archive Wet // 230V**, D0.0019818  
includes:  
D0.0019817 1x ARRISCAN XT Archive // 230V  
D0.14900.0 1x 35mm and 16mm Wet Gate System

**ARRISCAN XT Archive Wet // 110V**, D0.0019816  
includes:  
D0.0019815 1x ARRISCAN XT Archive // 110V  
D0.14900.0 1x 35mm and 16mm Wet Gate System

### ARRISCAN XT



**ARRISCAN XT Archive // 230V**, D0.0019817  
includes:  
D1.0016977 1x ARRISCAN XT  
D2.0019752 1x 35mm Archive Pin Gate Package (28.0 mm x 21.5 mm)  
D2.14935.0 1x 16mm Archive Pin Gate Package (14.2 mm x 9.1 mm)  
D2.14355.1 1x Built-In Stabilization  
D2.0020671 1x AXT UPS 230V

**ARRISCAN XT Archive // 110V**, D0.0019815  
includes:  
D1.0016977 1x ARRISCAN XT  
D2.0019752 1x 35mm Archive Pin Gate Package (28.0 mm x 21.5 mm)  
D2.14935.0 1x 16mm Archive Pin Gate Package (14.2 mm x 9.1 mm)  
D2.14355.1 1x Built-In Stabilization  
D2.0020774 1x AXT UPS 110V

### Wet Gate



**35mm and 16mm Wet Gate System**, D0.14900.0  
Complete 35mm and 16mm Wet Gate System for scratch concealment while scanning.  
Note: Requires compressed air supply, filtered and oilfree; Kodika SES liquid must be purchased separately at supplier.  
includes:  
D2.14800.0 1x 35mm Wet Gate (34.5 mm x 21.9 mm)  
D2.14700.0 1x 16mm Wet Gate (13.2 mm x 10.0 mm)  
D2.14900.0 1x Wet Gate Tower  
D4.13023.0 1x Wet Gate Retrofit Set

### ARRISCAN XT Software Options

**Optical Sound Decoding System**, D0.0019236  
Stand alone certified hardware package and unique Image to Sound Tools audio decoding software extracts the optical soundtrack from ARRISCAN image files no matter whether it is print film or sound negative, variable density or variable area.  
includes:  
D2.0019231 1x Optical Sound Decoding Software License  
D2.0019232 1x Optical Sound Decoding Workstation



**IR-Cleaner**, D0.0019788  
Software License to use the ARRISCAN XT raw infrared channel for third party products, incl. special DIAMANT-Film IR-Cleaner dust busting GUI application for running on ARRISCAN XT  
includes:  
D2.0019781 1x IR-Cleaner Software License  
10.0019777 1x Infrared System ARRISCAN XT



**IR-Cleaner DustBuster+**, D0.0019786  
Software License to use the ARRISCAN XT raw infrared channel for third party products, including DIAMANT-Film DustBuster+ for running on ARRISCAN XT.  
includes:  
D2.0019780 1x DustBuster+ Software License  
10.0019777 1x Infrared System ARRISCAN XT

**Black & White Scan Mode**, 10.0044235  
Software license that enables the single color scan mode based only on red, green or blue exposure and supports the output of mono black and white DPX and TIFF files.



**ProRes**

**ProRes Output AXT**, 10.0048485  
The supported ProRes flavours are 422 HQ, 4444 and 4444 XQ. It is possible to write 10-, 12- and 16-bit DPX files in parallel to the ProRes MXF.

**16mm Wet Gate System**, D0.14700.0  
Complete 16mm Wet Gate System for scratch concealment while scanning.  
Note: Requires compressed air supply, filtered and oilfree; Kodika SES liquid must be purchased separately at supplier.  
includes:  
D2.14700.0 1x 16mm Wet Gate (13.2 mm x 10.0 mm)  
D2.14900.0 1x Wet Gate Tower  
D4.13023.0 1x Wet Gate Retrofit Set



### Networking & File Transfer

**Host Computer SAN Kit**, D2.0019890  
Dual Port 16 Gbit/s Gen 6 Fiber Channel PCIe 3.0 Host Bus Adapter (HBA) including SFPs provides an advanced storage connectivity solution for the ARRISCAN XT host computer to StorNext or CXFS SAN storage.



**Host Computer Fiber Ethernet Kit**, D2.0020102  
Dual Port Fiber 10 Gbit/s Ethernet PCIe 2.0 x8 network adapter with multimode SFP+ Transceivers to connect ARRISCAN XT host computer to NAS system or file server.



### Service & Maintenance

**ARRISCAN XT - Basic** 10.0019907  
included Key Benefits:  
• 15% discount on spare parts  
• Instant gate exchange in case of gate defect  
• Free of charge shipping costs within the EU  
• 16 hours free of charge service on-site  
• 1x free of charge on-site visit (incl. Travel expenses and travel time)  
• Free of charge software updates  
• Unlimited phone, e-mail and remote support  
• Reaction time within 24 hours

**ARRISCAN XT - Prime** 10.0020230  
included Key Benefits:  
• All spare parts included  
• Instant gate exchange in case of gate defect  
• Free of charge shipping costs within the EU  
• All necessary service visits covered  
• Free of charge software updates  
• Unlimited phone, e-mail and remote support  
• Reaction time within 24 hours

### Transport Options

**Sprocketless Set Full (up to Serial No. 125)**, D2.14380.0  
Sprocketless transport system incl. ultrasonic loop monitoring and special loopbuilders for traditional ARRISCANs not yet fitted with exchangeable sprockets



**Sprocketless Set Small (from Serial No. 125)**, D2.14370.0  
Sprocketless transport system incl. ultrasonic loop monitoring and special loopbuilders for ARRISCANs already fitted with exchangeable sprockets



**16mm Supporting Film Plate**, D2.0000482  
Plate supporting shrunken and warped film on the take up sides inches film core

### Wet Gate Accessories



**Additional Wet Gate Drying System**, D2.14940.0

**Wet Gate Preparation Kit Extended (up to Serial No. 110)**, D2.14920.0



**35mm Wet Gate (34.5 mm x 21.9 mm)**  
D2.14800.0



**16mm Wet Gate (13.2 mm x 10.0 mm)**  
D2.14700.0

**35mm Wet Gate System**, D0.14800.0  
Complete 35mm Wet Gate System for scratch concealment while scanning.  
Note: Requires compressed air supply, filtered and oilfree; Kodika SES liquid must be purchased separately at supplier.  
includes:  
D2.14800.0 1x 35mm Wet Gate (34.5 mm x 21.9 mm)  
D2.14900.0 1x Wet Gate Tower  
D4.13023.0 1x Wet Gate Retrofit Set



# Upgrade ARRISCAN to ARRISCAN XT



Configuration Overview | 9.2.0 / 2025.03

## ARRISCAN → ARRISCAN XT



ARRISCAN

XT - Upgrade Package

ARRISCAN XT

**ARRISCAN XT - Upgrade Package // 230V** D2.0016979  
**ARRISCAN XT - Upgrade Package // 110V** D2.0019855

ARRISCAN XT on-site upgrade available for all Arriscan „Classic“. Includes camera head replacement to ALEXA XT sensor, exchange of image processing unit, power supply unit, illumination rack, touch panel, new ARRISCAN XT branding, GUI software update, new UPS and new host computer integrated in ARRISCAN housing. Fully compatible to all existing film gates, wet gate system and sprocketless transport.

Note:  
 > Ownership of replaced parts will pass to ARRI  
 > Renewed 12 month manufacturer warranty for exchanged new components

## ARRISCAN XT Software Options

**Optical Sound Decoding System**, D0.0019236  
 Stand alone certified hardware package and unique Image to Sound Tools audio decoding software extracts the optical soundtrack from ARRISCAN image files no matter whether it is print film or sound negative, variable density or variable area. includes:  
 D2.0019231 1x Optical Sound Decoding Software License  
 D2.0019232 1x Optical Sound Decoding Workstation



**IR-Cleaner**, D0.0019788  
 Software License to use the ARRISCAN XT raw infrared channel for third party products, incl. special DIAMANT-Film IR-Cleaner dust busting GUI application for running on ARRISCAN XT includes:  
 D2.0019781 1x IR-Cleaner Software License  
 10.0019777 1x Infrared System ARRISCAN XT



**IR-Cleaner DustBuster+**, D0.0019786  
 Software License to use the ARRISCAN XT raw infrared channel for third party products, including DIAMANT-Film DustBuster+ for running on ARRISCAN XT. includes:  
 D2.0019780 1x DustBuster+ Software License  
 10.0019777 1x Infrared System ARRISCAN XT

**Black & White Scan Mode**, 10.0044235  
 Software license that enables the single color scan mode based only on red, green or blue exposure and supports the output of mono black and white DPX and TIFF files.

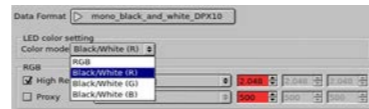

**ProRes**

**ProRes Output AXT**, 10.0048485  
 The supported ProRes flavours are 422 HQ, 4444 and 4444 XQ. It is possible to write 10-, 12- and 16-bit DPX files in parallel to the ProRes MXF.

**Built-In Stabilization**, D2.14355.1  
 Software license for on-the-fly image stabilization referenced to perf position, when pin-registered scanning is not possible. Registration pin must be retracted.

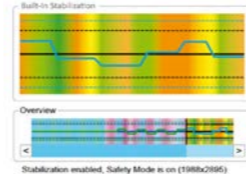

## Networking & File Transfer

**Host Computer SAN Kit**, D2.0019890  
 Dual Port 16 Gbit/s Gen 6 Fiber Channel PCIe 3.0 Host Bus Adapter (HBA) including SFPs provides an advanced storage connectivity solution for the ARRISCAN XT host computer to StorNext or CXFS SAN storage.



**Host Computer Fiber Ethernet Kit**, D2.0020102  
 Dual Port Fiber 10 Gbit/s Ethernet PCIe 2.0 x8 network adapter with multimode SFP+ Transceivers to connect ARRISCAN XT host computer to NAS system or file server.



## Transport Options

**Sprocketless Set Full (up to Serial No. 125)**, D2.14380.0  
 Sprocketless transport system incl. ultrasonic loop monitoring and special loopbuilders for traditional ARRISCANs not yet fitted with exchangeable sprockets



**Sprocketless Set Small (from Serial No. 125)**, D2.14370.0  
 Sprocketless transport system incl. ultrasonic loop monitoring and special loopbuilders for ARRISCANs already fitted with exchangeable sprockets



**16mm Supporting Film Plate**, D2.0000482  
 Plate supporting shrunken and warped film on the take up sides inches film core



## Wet Gate accessories

**Additional Wet Gate Drying System**, D2.14940.0



**Wet Gate Preparation Kit Extended (up to Serial No. 110)**, D2.14920.0

## Film Gate upgrades

**35mm Archive Pin Gate Upgrade Package**, D0.0020755  
 Upgrade from regular pin registered 35mm Gate (D2.0019653) to 35mm Archive Pin Gate with oversized aperture (28.0 mm x 21.5 mm) includes:  
 D2.0019031 1x 35mm Archive Pin Gate Upgrade  
 D2.14355.1 1x Built-In Stabilization

**16mm Archive Pin Gate Upgrade Package**, D0.14325.0  
 Upgrade from regular 16mm Gate (D2.14200.0) to 16mm Archive Pin Gate with oversized aperture (14.2 mm x 9.1 mm) includes:  
 D2.14936.0 1x 16mm Archive Pin Gate Upgrade  
 D2.14355.1 1x Built-In Stabilization

**35mm Archive Pin Gate Upgrade**, D2.0019031  
 Upgrade from regular pin registered 35mm Gate (D2.0019653) to 35mm Archive Pin Gate with oversized aperture (28.0 mm x 21.5 mm)

**16mm Archive Pin Gate Upgrade**, D2.14936.0  
 Upgrade from regular 16mm Gate (D2.14200.0) to 16mm Archive Pin Gate with oversized aperture (14.2 mm x 9.1 mm)

## Service & Maintenance

**ARRISCAN XT Upgrade - Prime** 10.0021165  
 The Prime XT Upgrade contract is the perfect complement to ensure that you get the best possible service for your upgraded ARRISCAN XT. All spare parts and related service needs which are not included in the XT Upgrade Package are covered.

- Key Benefits:
- Includes all spare parts which are not part of the XT Upgrade Package
  - Instant gate exchange in case of gate defect
  - Free of charge shipping costs within the EU
  - All necessary service visits covered
  - Free of charge software updates
  - Unlimited phone, e-mail and remote support
  - Reaction time within 24 hours

## Wet Gate

Wet Gate also compatible without XT upgrade



**35mm and 16mm Wet Gate System**, D0.14900.0  
 Complete 35mm and 16mm Wet Gate System for scratch concealment while scanning.  
 Note: Requires compressed air supply, filtered and oilfree; Kodika SES liquid must be purchased separately at supplier.  
 includes:  
 D2.14800.0 1x 35mm Wet Gate (34.5 mm x 21.9 mm)  
 D2.14700.0 1x 16mm Wet Gate (13.2 mm x 10.0 mm)  
 D2.14900.0 1x Wet Gate Tower  
 D4.13023.0 1x Wet Gate Retrofit Set



**16mm Wet Gate System**, D0.14700.0  
 Complete 16mm Wet Gate System for scratch concealment while scanning.  
 Note: Requires compressed air supply, filtered and oilfree; Kodika SES liquid must be purchased separately at supplier.  
 includes:  
 D2.14700.0 1x 16mm Wet Gate (13.2 mm x 10.0 mm)  
 D2.14900.0 1x Wet Gate Tower  
 D4.13023.0 1x Wet Gate Retrofit Set



**35mm Wet Gate System**, D0.14800.0  
 Complete 35mm Wet Gate System for scratch concealment while scanning.  
 Note: Requires compressed air supply, filtered and oilfree; Kodika SES liquid must be purchased separately at supplier.  
 includes:  
 D2.14800.0 1x 35mm Wet Gate (34.5 mm x 21.9 mm)  
 D2.14900.0 1x Wet Gate Tower  
 D4.13023.0 1x Wet Gate Retrofit Set



**35mm Wet Gate (34.5 mm x 21.9 mm)**  
 D2.14800.0



**16mm Wet Gate (13.2 mm x 10.0 mm)**  
 D2.14700.0