

cforce mini RF Software Update Package 2.1

USER MANUAL

April 2024 • 4.0 • English



Disclaimer

Before using the product, be sure to read and understand all respective instructions.

The product is available for commercial customers only.

For product specification changes since this document was published, refer to the latest publications of ARRI data sheets or data books, etc., for the most up-to-date specifications.

Not all products and / or types are available in every country. Please check with an ARRI sales representative for availability and additional information.

The information given in this document is subject to change without notice.

While ARRI endeavors to enhance the quality, reliability and safety of their products, customers agree and acknowledge that the possibility of defects thereof cannot be eliminated entirely. To minimize risk of damage to property or injury (including death) to persons arising from defects in the products, customers must incorporate adequate safety measures in their work with the system and have to heed the stated canonic use.

ARRI or its subsidiaries expressly exclude any liability, warranty, demand or other obligation for any claim, representation, or cause, or action, or whatsoever, express or implied, whether in contract or tort, including negligence, or incorporated in terms and conditions, whether by statute, law or otherwise. In no event shall ARRI or its subsidiaries be liable for or have a remedy for recovery of any special, direct, indirect, incidental, or consequential damages, including, but not limited to lost profits, lost savings, lost revenues or economic loss of any kind or for any claim by third party, downtime, good will, damage to or replacement of equipment or property, any cost or recovering of any material or goods associated with the assembly or use of our products, or any other damages or injury of the persons and so on or under any other legal theory.

Neither ARRI nor its subsidiaries assume any liability for infringement of patents, copyrights or other intellectual property rights of third parties by or arising from the use of ARRI products or any other liability arising from the use of such products. No license, express, implied or otherwise, is granted under any patents, copyrights or other intellectual property right of ARRI or others.

In the case one or all of the foregoing clauses are not allowed by applicable law, the fullest extent permissible clauses by applicable law are validated.

Imprint

© 2024 Arnold & Richter Cine Technik GmbH & Co. Betriebs KG. All rights reserved.

The device contains proprietary information of Arnold & Richter Cine Technik GmbH & Co. Betriebs KG; it is provided under a license agreement containing restrictions on use and disclosure and protected by copyright law. Reverse engineering of the software is prohibited.

No part of this publication may be used for distribution, reproduction, transmission, transcription, storage in a data retrieval system, or translated into any language in any form by any means without the prior written permission of Arnold & Richter Cine Technik GmbH & Co. Betriebs KG.

If you are downloading files from our web pages for your personal use, make sure to check for updated versions.

ARRI cannot take any liability whatsoever for downloaded files, as technical data are subject to change without notice.

Due to continued product development the information in this document may change without notice. The information and intellectual property contained herein is confidential between ARRI and the client and remains the exclusive property of ARRI. If you find any problems in the documentation, please report them to us in writing. ARRI does not warrant that this document is flawless.

For Further Assistance

ARRI Cine + Video Geräte Gesellschaft m.b.H.

Pottendorferstrasse 23-25/3/2/1

A-1120 Vienna

Austria

E-mail: service@arri.com

Website: www.arri.com/en/technical-service

Original version.

Content

1	About this document	6
2	Safety Instructions	7
3	About this product	10
3.1	Audience and intended use	10
3.2	Scope of delivery and warranty	10
3.3	Certification and Safety Standards	11
4	Introduction	13
4.1	Connectors	13
5	Motor Layout	14
5.1	Control Panel	14
5.2	Setup	15
	Encoder Mode	17
5.3	Status LEDs	17
6	Motor Preparation	18
6.1	Mounting to 19mm rods	18
6.2	Mounting to 15mm rods	18
6.3	Mounting to Panavison rods	18
6.4	Setting up Motor	18
6.5	Connecting to Hand Unit	18
7	Compatibility and Sample Configuration	20
8	Software Update	27
8.1	How to get a Software Update Package	27
8.2	Update Procedure	27
8.3	Update with Hi-5 via USB	27
8.4	Update with Hi-5 via ECS Sync App	28
8.5	Update with ALEXA Mini, ALEXA Mini LF and ALEXA 35	28
9	Power Disconnection	29
10	Appendix	30
10.1	Antenna Connector	30
10.2	Specifications	30
10.3	Dimensions and weight	31
10.4	Pinouts	31
10.5	Part Numbers	32
11	ARRI Service Contacts	35

1 About this document

This user manual contains detailed information about the features and functionalities of the device. Please visit the website <http://www.arri.com> to download the operating manual, where applicable, and much more information about this and other ARRI products.

Keep all manuals and all other operating and assembly instructions belonging to the device in a safe place for future reference and possible subsequent owners

The ARRI Academy courses provide unrivalled insights into the full possibilities of working with ARRI camera systems, lenses, lighting systems and accessories.

Our advanced service training courses are designed to transfer detailed knowledge about how to service and repair all types of ARRI products and give you permanent access to detailed service instructions, special tools and service parts. To learn more, please visit [ARRI academy](#) or contact academy@arri.de.

For more details about the product, please refer to the ARRI website at:

[cforce mini RF product page](#)



Searchkeys:
cforce mini RF , D4510002881,
K2.00216802

[ARRI documentation portal](#)



Document Revision History

Document ID: D45 1000 2881

Version	Release	Date	Note
1.0	F06617	May 2018	First Release
1.1	W01412	September 2018	
2.0	W01453	December 2018	
3.0	W01463	April 2021	
4.0	W01977	April 2024	

2 Safety Instructions

This safety information is in addition to the specific operating instructions in general and must be strictly observed for safety reasons. Read and understand all safety and operating instructions before you operate or install the device. Retain all safety and operating instructions for future reference. Always follow the instructions in this and all documents supplied with the device to avoid injury to yourself or others and damage to the device or other objects.

Assembly and operation should only be carried out by trained staff familiar with the device. Only use the tools, materials and procedures recommended in this document. For the correct use of other equipment, see the manufacturer's instructions.

These instructions use safety instructions, warning symbols and signal words to draw your attention to different levels of risk:



DANGER

DANGER indicates an imminent danger. If not avoided, death or serious injury will result.

Always follow the recommended measures to avoid this hazardous situation.



WARNING

WARNING indicates a possibly imminent danger. If not avoided death or serious injury may result.

Always follow the recommended measures to avoid this potentially hazardous situation.



CAUTION

CAUTION indicates a potentially imminent danger. If not avoided, slight or minor injuries may result.

Always follow the recommended measures to avoid this potentially hazardous situation.



NOTICE

NOTICE indicates a potentially harmful situation. If not avoided, the equipment or something in its surrounding may be damaged.

Always follow the recommended measures to avoid this situation.

HINT

Not relevant to safety, **HINT** provides additional information to clarify or simplify a procedure.

Warning Symbols and Product Labels



General warning sign



Warning of electrical voltage



Warning of hot surfaces



Warning of sharp element



Warning of the risk of crushing



Warning of obstacles on the ground



Please read all instructions carefully before using the product for the first time.



Direct Current symbol found on electronics requiring or producing DC power.

General Safety Instructions



DANGER

Risk of Electric Shock and Fire!

Risk of short-circuits and back currents to power supplies / batteries.

- ▶ Before use, read and follow all relevant instructions.
- ▶ Use solely and exclusively as described in the instructions.
- ▶ Always use original ARRI / cmotion LBUS cables to external power sources (D-Tap, XLR). ARRI/cmotion LBUS cables to external power sources provide a protection circuit to prevent back currents to power supplies/batteries.
- ▶ Do not open the device.
- ▶ Do not insert objects into the device.



WARNING

Operation of the cforce mini RF in Case of Obvious Damage

Risk of electric shock and fire hazard caused by short circuit.

- ▶ Never use the device if electrical lines or housing are visibly damaged.
- ▶ Only use the type of power source indicated in the manual.
- ▶ Always grip the power plug to unplug the power cable.
- ▶ Do not lay cables over sharp edges (e.g. sheet metal, profile or other cut edges). Damaged cables can cause electric shock, short circuit or fire.
- ▶ Do not remove or deactivate any safety measures from the device (incl. warning stickers or paint marked screws).
- ▶ Do not try to repair the device. Repairs may only be carried out by an authorized ARRI service center.



WARNING

Falling System Parts

Do not built up or assemble the cforce mini RF the wrong way. It can fall down and cause serious injuries and damage to the device or property.

- ▶ Installation and operation must only be carried out by approved persons who know the device. Obey the accident prevention regulations.
- ▶ Never put the device on a not stable trolley or hand truck, stand, tripod, bracket, table or any other not stable support device.
- ▶ Always place the device on dedicated support devices.
- ▶ Always use a suitable safety rope when you use the device above floor level (i.e. on cranes).
- ▶ Secure the device and its accessories against falling and tipping over. Obey the general and local safety regulations.



CAUTION

Use of the cforce mini RF in a Humid Environment and with Condensation

When you move the device and the accessories from a cool to a warm location or when the device is used in a damp environment, condensation may form inside the device, and on internal or external electrical connections. Do not operate the device while condensation is present. It bears risk of electric shock and/or fire caused by a short circuit.

- ▶ Do not operate the device and accessories when condensation occurs.
- ▶ When you move the device and accessories from a cool to a warm environment, wait for some time for the components to warm up.
- ▶ Find a warmer storage location to decrease the risk of condensation.



CAUTION

Rotating Lens Motor

Risk of crushing fingers and capturing and unraveling long hair, jewelry and/or clothing.

- ▶ Make sure that the lens motor is properly attached to the lens.
- ▶ Do not touch the lens motor gears while they are moving.
- ▶ Keep hair and loose clothing away from the motor gear teeth.
- ▶ Keep cables connected to the camera away from the motor gear teeth.

3 About this product

3.1 Audience and intended use



NOTICE

All versions of the cforce mini RF and its accessories are intended exclusively for professional use. It must be used only by skilled and trained personnel. The product and its accessories must not be used by inexperienced users and without proper training.

Read and understand the operating manual and the user manual before use.

Use the product and its accessories only for the purpose described in this document. Always follow the safety instructions and system requirements for all equipment involved. ARRI assumes no liability for damages or changes that are caused by improper use. You are not allowed to modify the product and its accessories.

3.2 Scope of delivery and warranty



NOTICE

The packaging consists of recyclable materials. For the sake of the environment, dispose the packaging material at a suitable disposal site. Always store, ship and dispose according to local regulations. ARRI is not liable for consequences from inadequate storage, shipment or disposal.

On delivery, please check if package and content are intact. Never accept a damaged or incomplete delivery.

Delivery

A complete cforce mini RF Basic Set 2 KK.0040345 includes:

- 1x K2.0016802 cforce mini RF
- 1x K2.0036610 cforce mini Clamp Console 2 19/15mm (including K2.0038503 cforce mini Clamp Insert 2 15mm)
- 1x K2.0003753 cforce mini gear m0.8, 40t

For scope of warranty, please ask your local ARRI Service Partner. ARRI is not liable for consequences from inadequate shipment, improper use or use of third-party products.

3.3 Certification and Safety Standards

EU Declaration of Conformity



Brand Name: ARRI
 Product Description: Lens Motor
 cforce mini RF

The designated products conform to the specifications of the following European directives:

- Directive 2014/53/EU of the European Parliament and the Council of 16 April 2014 on the harmonization of the laws of the Member States relating to the making available on the market of radio equipment and repealing Directive - OJ L 153, 22.5.2014, S. 62–106.
- Directive 2011/65/EU of the European Parliament and the Council of June 8, 2011 on the restriction of the use of certain hazardous substances in electrical and electronic equipment and the Commission Delegated Directive (EU) 2015/863 of March 31, 2015.

The compliance with the requirements of the European Directives has been verified by applying the following standards:

- EN 62368-1:2014 + AC:2015-05 + AC:2015-11
- EN 301 489-1 V2.1.1; EN 301 489-17 V3.1.1
- EN 300 328 V2.1.1
- EN 50581:2012

Year of affixed CE-marking: 2024

The manufacturer bears sole responsibility for issuing this declaration of conformity.

FCC Class A Statement

This device complies with Part 15 of the FCC rules. Operation is subject to the following two conditions:

- (1) This device may not cause harmful interference, and
- (2) this device must accept any interference received, including interference that may cause undesired operation.

Changes or modifications not expressly approved by the manufacturer could void the user's authority to operate the equipment

UKCA Declaration of Conformity



Brand Name: ARRI
 Product Description: Lens Motor
 cforce mini RF

The designated products conform to the specifications of the following United Kingdom regulations:

1. The Electromagnetic Compatibility Regulations 2016
2. The Restriction of the Use of Certain Hazardous Substances in Electrical and Electronic Equipment Regulations 2012

The compliance with the requirements of the United Kingdom regulations was proved by the application of the following standards:

- EN 62368-1:2014 + AC:2015-05 + AC:2015-11
- EN 301 489-1 V2.1.1; EN 301 489-17 V3.1.1
- EN 300 328 V2.1.1
- EN 50581:2012

Industry Canada Compliance Statement

Complies with CAN ICES-003(A)/NMB-003(A). This device complies with Industry Canada license - exempt RSS standard(s). Operation is subject to the following two conditions: (1) This device may not cause interference, and (2) this device must accept any interference, including interference that may cause undesired operation of the device.

Le présent appareil est conforme aux CNR d'Industrie Canada applicables aux appareils radio exempts de licence. L'exploitation est autorisée aux deux conditions suivantes : (1) l'appareil ne doit pas produire de brouillage, et (2) l'utilisateur de l'appareil doit accepter tout brouillage radioélectrique subi, même si le brouillage est susceptible d'en compromettre le fonctionnement.

Korean Declaration of Conformity



Company Name: Arnold & Richter Cine Technik GmbH & Co Betriebs KG

Equipment Name: cforce

Model Name: cforce mini RF

Manufacturer: ARRI Cine + Video Geräte Ges.m.b.H./Austria

R-REM-ARg-cforce-mini-RF

4 Introduction



ARRI and cmotion have partnered up to develop the new intelligent cforce mini RF motor.

The ARRI cforce mini RF is an intelligent lens motor with integrated white-coded ARRI radio module, eliminating the need for an additional receiver unit mounted on the camera.

The cforce mini RF can pair with up to three hand units for split focus, iris, zoom and AUX operation and provides full lens data when used with the Hi-5 or other ARRI hand units.

The simple user interface includes two soft buttons and a display for setting the motor axis, triggering motor calibration and selecting one of the 14 radio channels.

Using the LBUS interface, the system can be expanded with up to two additional cforce motors while the CAM connector provides a versatile interface for power supply and run/stop control for cameras including ARRI, Red, Sony, Canon and Blackmagic. Extended Hi-5 camera control is included for ARRI cameras while Hi-5 Camera Control licenses are available for RED and Sony Venice cameras. For further information about licenses please visit alshop.arri.de

Main Features

- Integrated RF-EMIP radio module
- Supports lens data with ARRI hand units
- Daisy-chainable via LBUS
- Small and lightweight (~237g/8.4oz incl. gear and antenna)
- Compatible with all hand units containing ARRI's white-coded RF-EMIP radio module

4.1 Connectors

LBUS

LBUS is a bus standard designed to allow multiple lens motors and control devices to communicate with each other. The cforce mini RF motor has a bidirectional LBUS interface, providing power and control signals to the motor.

CAM

In addition, it contains a CAM interface to control ARRI or third-party cameras and lenses.

5 Motor Layout



1. Antenna
2. Gear
3. Display
4. Upper soft button
5. Lower soft button
6. CAM Connector
7. LBUS Connector

5.1 Control Panel

The cforce mini RF features a user interface to configure the system. The display shows menu and status information.



Soft Buttons

Two soft buttons are located below the display. They change their functionality depending on the screen content.

Menu Navigation

Use the soft buttons to enter the setup menus as follows:

Menu	Buttons	Press button...
Motor axis (F/I/Z/A)	Upper button	short
Motor calibration	Upper button	long (3 sec)
Flip screen	Upper button	short (in menu "System info")
Region settings	Lower button	6 sec
RF channel	Lower button	short
System info	Lower button	long (3 sec)
Factory reset	Both buttons	long (6sec)

HINT

Main screen turns off after 3 seconds.

5.2 Setup

Motor Assignment

Push the upper button short to assign motor to focus, iris, zoom or AUX control. Make sure that the assignment matches the lens axis the motor is attached to.

Motor Calibration

Press and hold the upper button for three seconds to start the automatic calibration of the motor. Press the upper button shortly to interrupt the calibration process.

System Info

Press and hold the lower button for three seconds to view the system info. The *System info* shows the current firmware version.

Region Settings

RF offers radio settings for different areas (with RF-EMIP radio module). Make sure that you select the proper area you are operating the device in. All available region settings comply with Part 15 of the FCC rules.

Press and hold the lower button for 6 seconds to enter the region settings menu. Push shortly to toggle through the regions. Select *World* if your specific region is not listed.

Region Setting	Country Code
Australia	AU
Canada	CA
China	CN
Egypt	EG
Europe	EU
Hong Kong	HK
India	IN
Japan	JP
New Zealand	NZ
Philippines	PH
Singapore	SG
South Africa	ZA
South Korea	KR
Taiwan	TW
Thailand	TH
UAE (United Arab Emirates)	AE
USA	US
World	WORLD

Radio Mode

Host Mode

In case the cforce mini RF is set to host mode (Radio channel 0-13, Radio OFF), its internal motor controller is switched on. This is the classical configuration for third-party camera setups.

Client Mode

In case the cforce mini RF is set to client mode (Client), its internal motor controller is switched off and it behaves like a classic cforce motor only. This is the standard wireless configuration with ARRI cameras that contain an internal EMIP radio module (e.g. ALEXA Mini, ALEXA Mini LF, ALEXA 35).

Radio Channel

The *RF* menu lets you switch the radio on and off and select the radio channel. Press the lower button shortly to enter the *Radio* menu. Toggle through the channels until you reach the desired Radio channel. The channel will be automatically set after three seconds.

RF (Radio)	Note
OFF	Radio=OFF / Motor Controller = ON
0	
1	
2	
3	
4	
5	
6	
7	
8	
9	
10	
11	
12	
13	
Client	Radio = OFF / Motor Controller = OFF

Encoder Mode

The cforce mini RF motor features an encoder mode. This mode allows the lens axis held by a lens motor to be rotated manually, by hand, while still allowing lens data from custom lens files to be recorded and displayed.

Setup:

- Attach the motor as usual and connect it to the LBUS daisy chain
- Load a Lens File
- Calibrate motor either via the hand unit (e.g. Hi-5), the motor controller or on the motor directly by pressing & holding the motor button until the motor starts calibrating.
- Make sure the motor is not controlled by any control device e.g. by deactivating the corresponding axis in the Hi-5

The top LED will flash green / red if everything is set up properly, indicating that the motor is calibrated, but not assigned to a control axis on a hand unit.

The LED will turn solid green and the display shows ENCODER as soon as the lens axis is rotated manually – indicating an active encoder mode.

HINT

Calibrate all via Hi-5

The calibrate all command from a Hi-5 calibrates all F/I/Z motors if a cforce mini RF, RIA-1, ALEXA 35 or ALEXA Mini LF is used as a radio host. AUX motors must be calibrated separately. On an ALEXA Mini or older cameras, only the motors which are actively controlled by the Hi-5 are calibrated.

5.3 Status LEDs

The top status LED indicates the motor status:

Top LED	Status
Solid green	Motor is ready and calibrated, no warnings
Solid green + "ENCODER" on display	Motor transitions to Encoder Mode
Green/red flashing	No motor control unit available (idle)
Yellow flashing	Motor is currently calibrating
Green/yellow flashing	Motor needs to be calibrated (calibration request)
Solid yellow	Motor is in calibration timeout state
Solid red	Motor power supply is below 10V

The bottom status LED indicates the motor controller status:

Bottom LED	Status
Solid green	Motor controller is ready, client connected
Green/red flashing	Motor controller is ready, no client connected
Yellow/red flashing	Selected channel used by another motor controller
Solid red	Motor initializing / hardware fault
Red flashing	Firmware Update ongoing
OFF	Motor is in client mode (motor controller is OFF)

6 Motor Preparation

6.1 Mounting to 19mm rods

1. Open the clamp console by turning the thumbscrew counterclockwise.
2. Remove the 19/15mm clamp insert (K2.0038503).
3. Attach the clamp console on the rod, with the motor gear engaged to the lens barrel.
4. Close the clamp console by turning the thumbscrew clockwise.

6.2 Mounting to 15mm rods

1. Open the clamp console by turning the thumbscrew counterclockwise.
2. Attach the 19/15mm clamp insert (K2.0038503) on the 15 mm rod.
3. Attach the clamp console around the clamp insert on the rod, with the motor gear at the respective lens barrel.
4. Close the clamp console by turning the thumbscrew clockwise.

Note: For high torque applications use CLM-4 Clamp insert (K2.0002080, not included)

6.3 Mounting to Panavison rods

1. Open the clamp console by turning the thumbscrew counterclockwise.
2. Remove the 19/15mm clamp insert.
3. Attach the cforce mini clamp insert 5/8" (K2.0038504, not included) to the 5/8" rod.
4. Attach the clamp console around the clamp insert on the rod, with the motor gear at the respective lens barrel.
5. Close the clamp console by turning the thumbscrew clockwise.

6.4 Setting up Motor

1. Press the lower button for six seconds to select the region you are in. Repeat this step whenever using it in a different region.
2. Use the upper button to assign the cforce motor to the focus, iris, zoom or AUX axis. Make sure that the assignment matches the lens axis the motor is attached to.
3. Select the radio channel via the lower button.
4. Press the upper button for three seconds to start the automatic calibration of the respective motor. Alternatively, activate the calibration process through the control device.

6.5 Connecting to Hand Unit

Set the hand unit to the same radio channel as the cforce mini RF (refer to user manual of the hand unit).

Set the motor side, torque and direction (refer to user manual of the hand unit).



CAUTION

Risk of injury!

Do not touch motor gear while motor is powered up!

This device is not intended for use by children. Keep body parts out of the motion path.

Disconnect the plug if the device is not used for a longer period of time.

IEC 60417-6056 (2011-05) for other moving parts

NOTICE**Temperature Shutdown**

Continuously operating the motor at high friction for a several minutes will cause a temperature shutdown, manifesting in reduced motor speed. Cooling down the motor will solve the issue.

7 Compatibility and Sample Configuration

The cforce mini RF is compatible with the following products and firmware versions:

Product	Firmware Version
Hi-5	2.1.0
ZMU-4	1.1.0
RIA-1	2.1.0
SXU-1	2.1.2
WCU-4	3.3.20
Master Grip	2.0.2
OCU-1	2.0.2
LCUBE CUB-1	3.0.0
cforce mini	2.0
cforce plus	2.0
UDM-1	1.0
Focusbug CineRT (via LCUBE CUB-1)	always update to latest firmware
cmotion Cinefade VariND	always update to latest firmware

For compatibility with cmotion products please contact cmotion directly.

cforce mini RF lens motors can be used in different applications, within ARRI systems. The following configurations are examples and not exhaustive:

ALEXA 35 and ALEXA Mini LF (SUP 7.3 or newer)

- 1) cforce mini RF as a radio host on an ALEXA 35 or ALEXA Mini LF (SUP 7.3 or newer)
- 2) OCU-1 with a cforce mini RF as a radio host on an ALEXA 35 or ALEXA Mini LF (SUP 7.3 or newer)
- 3) Focusbug and Cinefade with a cforce mini RF as a radio host on an ALEXA 35 or ALEXA Mini LF (SUP 7.3 or newer)

See detailed configuration examples on page 20/21

ALEXA Mini or ALEXA Mini LF (SUP 7.2 and older)

- 4) cforce mini RF as a radio host on an ALEXA Mini or ALEXA Mini LF (SUP 7.2 or older)
- 5) OCU-1 with a cforce mini RF as a radio host on an ALEXA Mini or ALEXA Mini LF (SUP 7.2 or older)
- 6) Focusbug and Cinefade with a cforce mini RF as a radio host on an ALEXA Mini or ALEXA Mini LF (SUP 7.2 or older)

See detailed configuration examples on page 22/23

3rd Party Camera - Cine Lens

- 7) cforce mini RF as a radio host on a 3rd party camera with cine lens
- 8) OCU-1 with a cforce mini RF as a radio host on a 3rd party camera with cine lens
- 9) Focusbug and Cinefade with a cforce mini RF as a radio host on a 3rd party camera with cine lens

See detailed configuration examples on page 24/25

Setup ALEXA 35 or Mini LF (SUP 7.3 or newer)

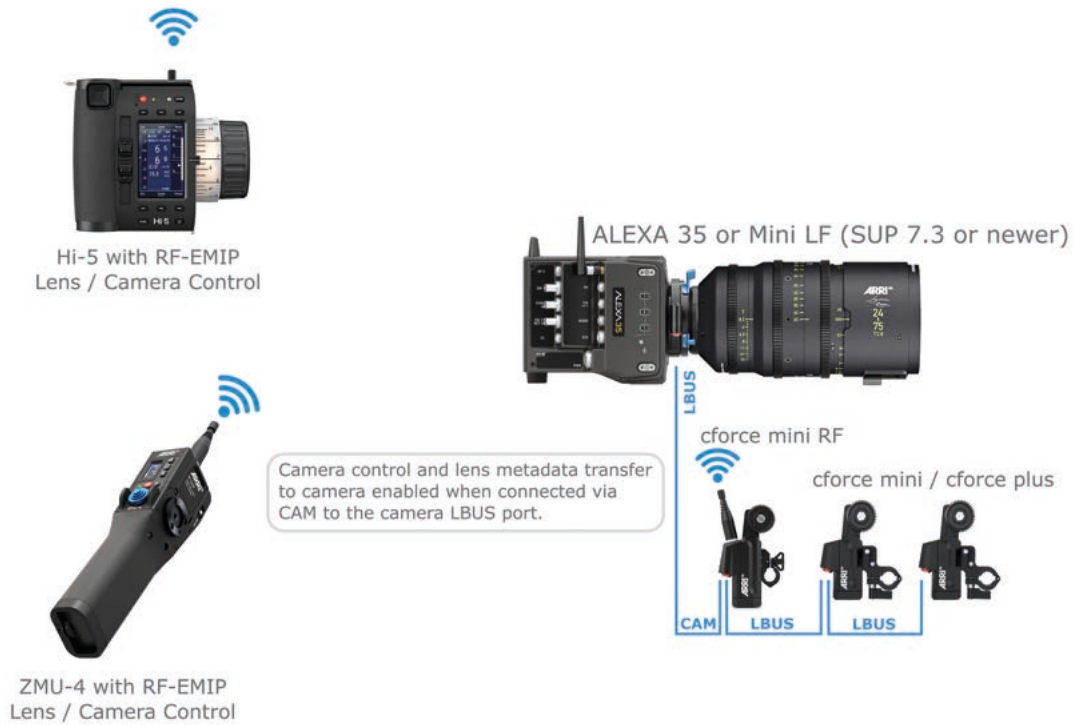

1) cforce mini RF as a radio host on an ALEXA 35 or ALEXA Mini LF (SUP 7.3 or newer)

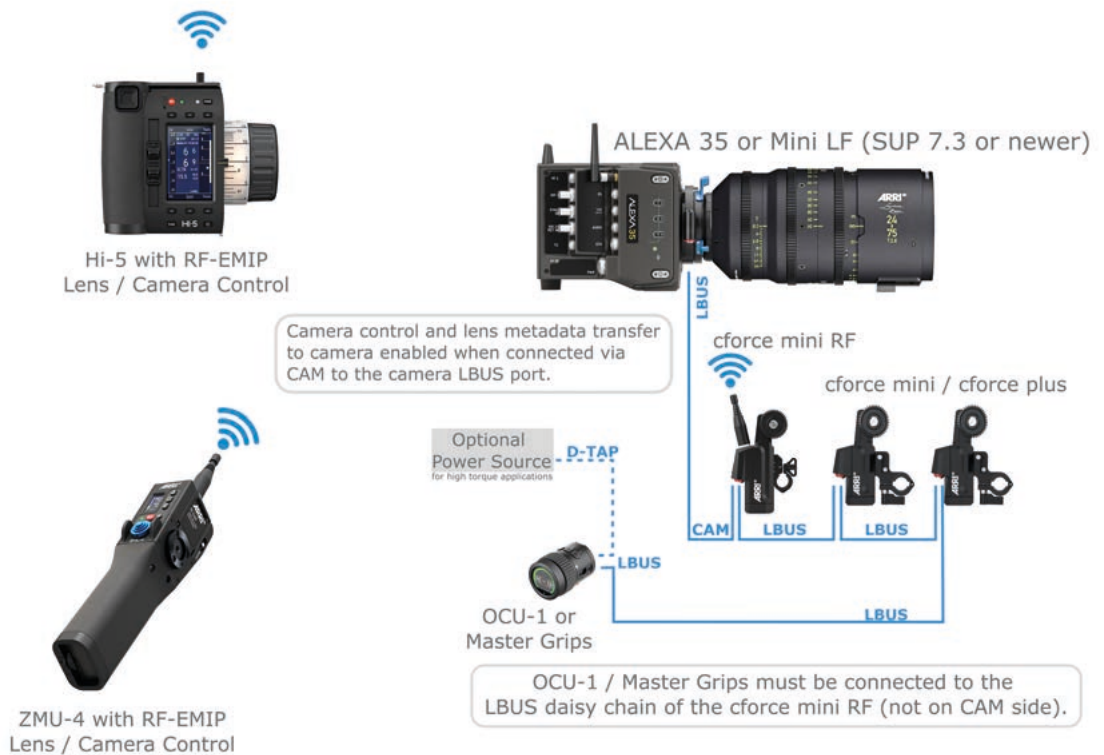

2) OCU-1 with a cforce mini RF as a radio host on an ALEXA 35 or ALEXA Mini LF (SUP 7.3 or newer)

Setup ALEXA Mini or ALEXA Mini LF (SUP 7.2 and older)



4) cforce mini RF as a radio host on an ALEXA Mini or ALEXA Mini LF (SUP 7.2 or older)

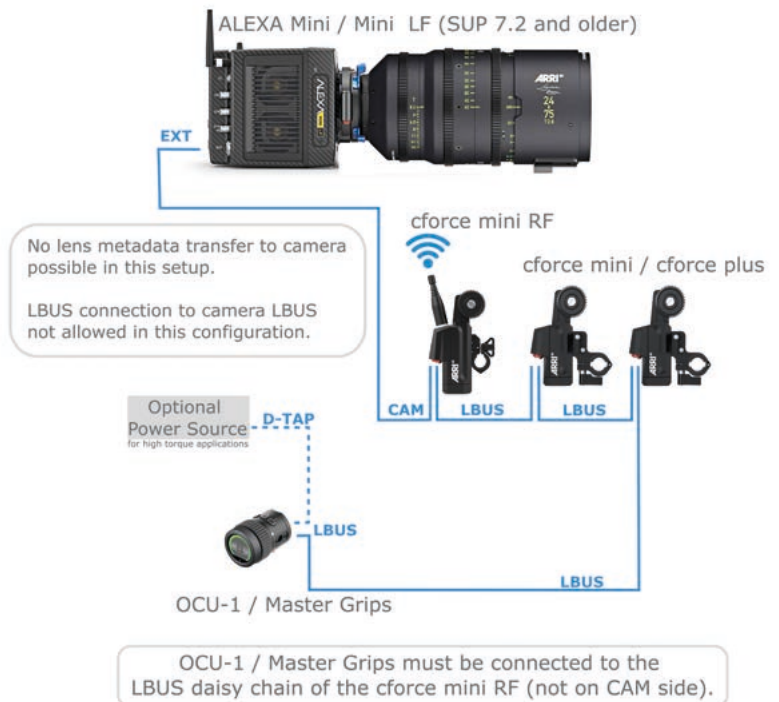

5) OCU-1 with a cforce mini RF as a radio host on an ALEXA Mini or ALEXA Mini LF (SUP 7.2 or older)

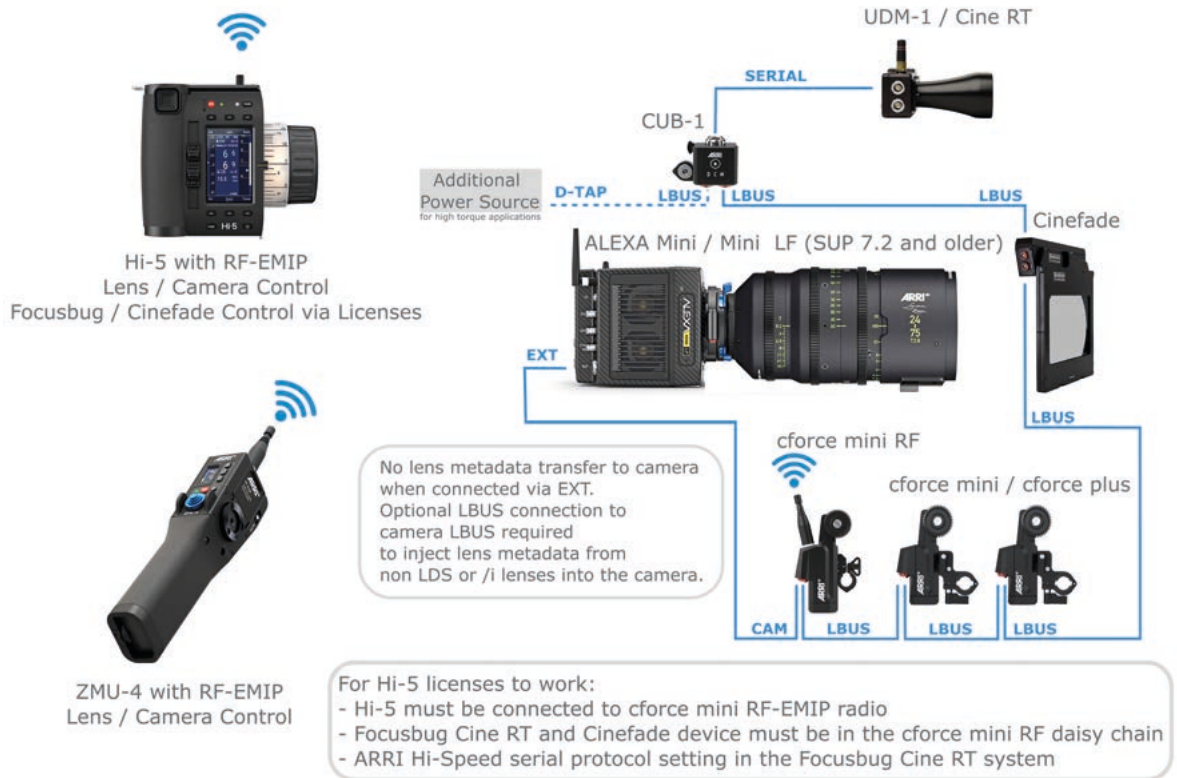

6) Focusbug and Cinefade with a cforce mini RF as a radio host on an ALEXA Mini or ALEXA Mini LF (SUP 7.2 or older)

Setup 3rd Party Camera - Cine Lens



7) cforce mini RF as a radio host on a 3rd party camera with cine lens



8) OCU-1 with a cforce mini RF as a radio host on a 3rd party camera with cine lens

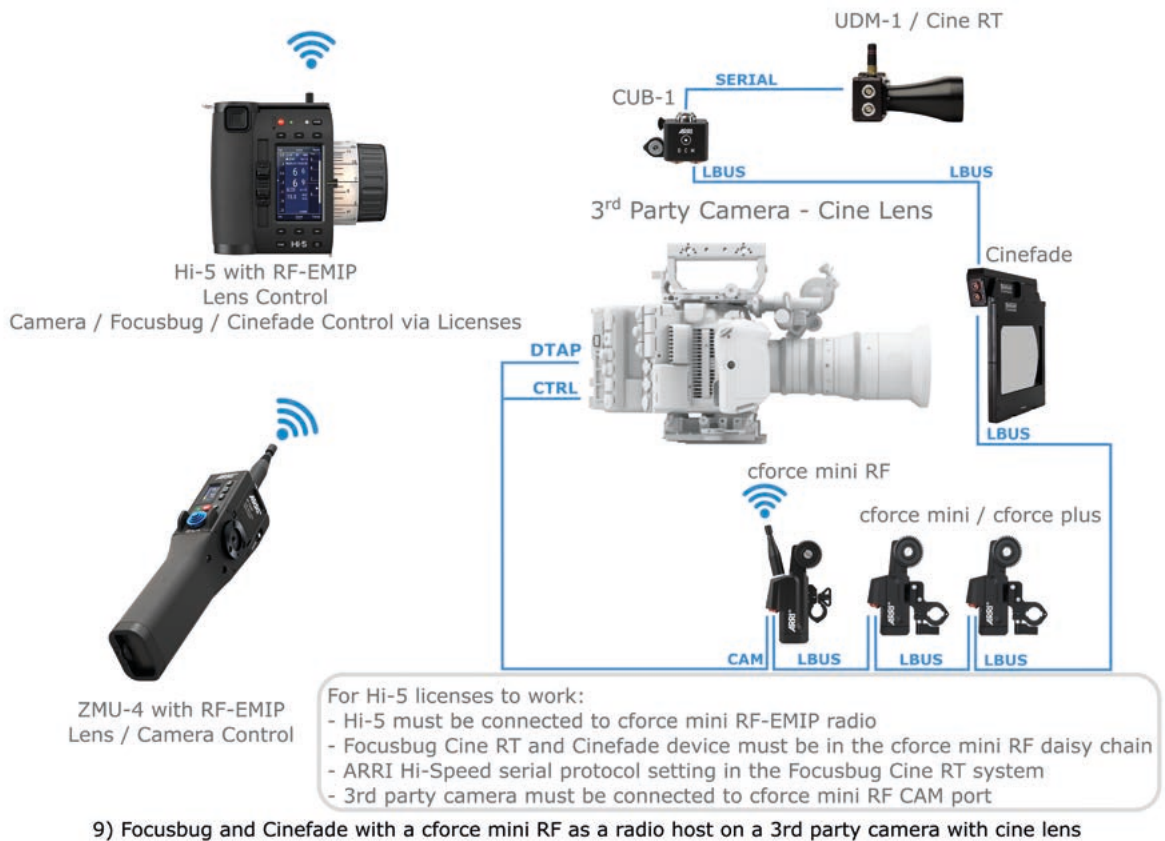

Please visit the ARRI website for a complete overview of all configurations:
[Configuration Overviews](#) | [Camera Systems](#) | [Learn & Help \(arri.com\)](#)

8 Software Update

8.1 How to get a Software Update Package

You can find the Software Update Package (SUP) in the Electronic Control Systems download section on:

[Overview Of All Current Software Update Packages | Technical Service | ARRI](#)

Download the latest Software Update Package to your computer.

8.2 Update Procedure

The cforce mini RF can be updated as LBUS device via Hi-5 (USB or ECS Sync App), WCU-4, UMC-4, ALEXA Mini, ALEXA Mini LF and ALEXA 35 cameras.

The following section provides details about updating the cforce mini RF via Hi-5 and an ARRI camera. Please refer to the owner's manual of the other devices for more details.

Caution: Update via CAM interface is not supported for cforce mini RF motors. Please update via the LBUS interface.

8.3 Update with Hi-5 via USB

The software can be updated using a USB-A or USB-C drive.

The USB-A slot is located below the display on the bottom of the Hi-5, covered by a plastic cap. Press the release pin to open the cover.

The USB-C slot is located above the display on the top side of the Hi-5, covered by a rubber cap. Lift and turn the rubber cap gently to access the USB-C slot.

Make sure the power supply of the Hi-5 is stable, e.g. by using a fully charged battery. Please note that power over USB is not recommended.

Preparing the USB Stick:

Copy the Software Update Package onto an USB memory stick in the folder ARRI/ECS/.

Performing the Update:

1. Connect the cforce mini RF LBUS port to the Hi-5 via LBUS (updating via CAM port is not supported!).
2. Connect the cforce mini RF to a power source (e.g. via CAM interface).
3. Turn the Hi-5 on.
4. Insert the USB stick in the corresponding USB slot of the Hi-5
5. Go to MENU > System > Update > LBUS Device Update.
6. Select the cforce mini RF motor you wish to update. The serial number is printed on the side of the motor.
7. Choose the desired Software Update Package and then press select to start the update.
8. Wait until the update process is finished.
9. Power cycle the cforce mini RF motor by disconnecting it from the power source.

NOTICE

Do not remove the USB Stick, unplug the motor or turn off the Hi-5 during the update!

8.4 Update with Hi-5 via ECS Sync App

The ECS Sync App connects to the Hi-5 via Bluetooth. The Bluetooth dongle must be connected to the lower USB-A port of the Hi-5.

Performing the Update:

1. Connect the cforce mini RF LBUS port to the Hi-5 via LBUS (updating via CAM port is not supported!).
2. Connect the cforce mini RF to a power source (e.g. via CAM interface).
3. Ensure that Bluetooth is enabled on the Hi-5 via MENU > System > Bluetooth.
4. Activate Bluetooth on your iOS device and add the Hi-5 to your device list (Hi-5 is shown as hi-5-xxxxx, with xxxxx being the serial number).
5. Open the ECS Sync App. The app is now connected to your Hi-5 hand unit.
6. Go to ARRI DEVICE > cforce mini RF xxxxx > Update to the latest SUP. The serial number is printed on the side of the motor.
7. Select Download and proceed the software update
8. Wait until the update process is finished.
9. Power cycle the cforce mini motor by disconnecting it from the power source.

NOTICE

Do not leave the app during the update!

8.5 Update with ALEXA Mini, ALEXA Mini LF and ALEXA 35

Precautions:

Have the ALEXA running with a stable power source during the update.

Preparing the USB Stick:

Copy the Software Update Package onto an USB memory stick in the folder ARRI/ECS/

Performing the Update:

1. Connect the cforce mini RF LBUS port to the camera LBUS port (connecting to the cforce mini RF CAM port is not recommended for updating).
2. Connect camera to a stable power source (e.g. AC power supply and on-board battery).
3. Connect the USB stick to the camera.
4. (In the camera menu, go to MENU > System > Update > LBUS.
5. Select the cforce mini RF that you wish to update and press the jog wheel. A confirmation screen is displayed. Press CONFIRM to start the update.
6. Choose the desired Software Update Package and then press the two UPDATE soft buttons simultaneously to start the update.
7. Wait until the update process is finished.
8. Power cycle the cforce mini RF motor by disconnecting it from the power source.

NOTICE

Do not remove the USB stick or turn off the camera during the update!

9 Power Disconnection



CAUTION

To disconnect the device safely from the power source, pull the plugs.
Mount and operate the device in an orientation that guarantees easy accessible plugs.

10 Appendix

10.1 Antenna Connector

The radio connection is established via the antenna mounted to the antenna connector. The radio module inside could be damaged by electrostatic discharge if no antenna is attached. We recommend using the originally supplied antenna only.

10.2 Specifications

Electrical data

Temperature range:	-20° to +50°C (-4° to +122°F)
Torque:	0.25 Nm (0.3 Nm peak)
Speed:	240 teeth/s (6 R/s) (all with gear m0.8, 40t)
Supply voltage:	12V - 34V
Power consumption:	max. 2 - 6A

Radio System

The cforce mini RF motor contains a radio unit that enables wireless lens control with a RF-EMIP radio module. A white ring at the base of the antenna mount identifies it. It offers 14 channels to choose from:

Channel	Frequency
0	2.410 GHz
1	2.415 GHz
2	2.430 GHz
3	2.435 GHz
4	2.450 GHz
5	2.455 GHz
6	2.470 GHz
7	2.475 GHz
8	2.420 GHz
9	2.425 GHz
10	2.440 GHz
11	2.445 GHz
12	2.460 GHz
13	2.465 GHz

RF-EMIP white radio and radios with other color coding cannot be mixed in the same radio network of camera and hand units. It is possible to use both systems in parallel within different radio networks.

NOTICE

ARRIs white radio and cmotions red radio are not compatible.

10.3 Dimensions and weight

Dimensions

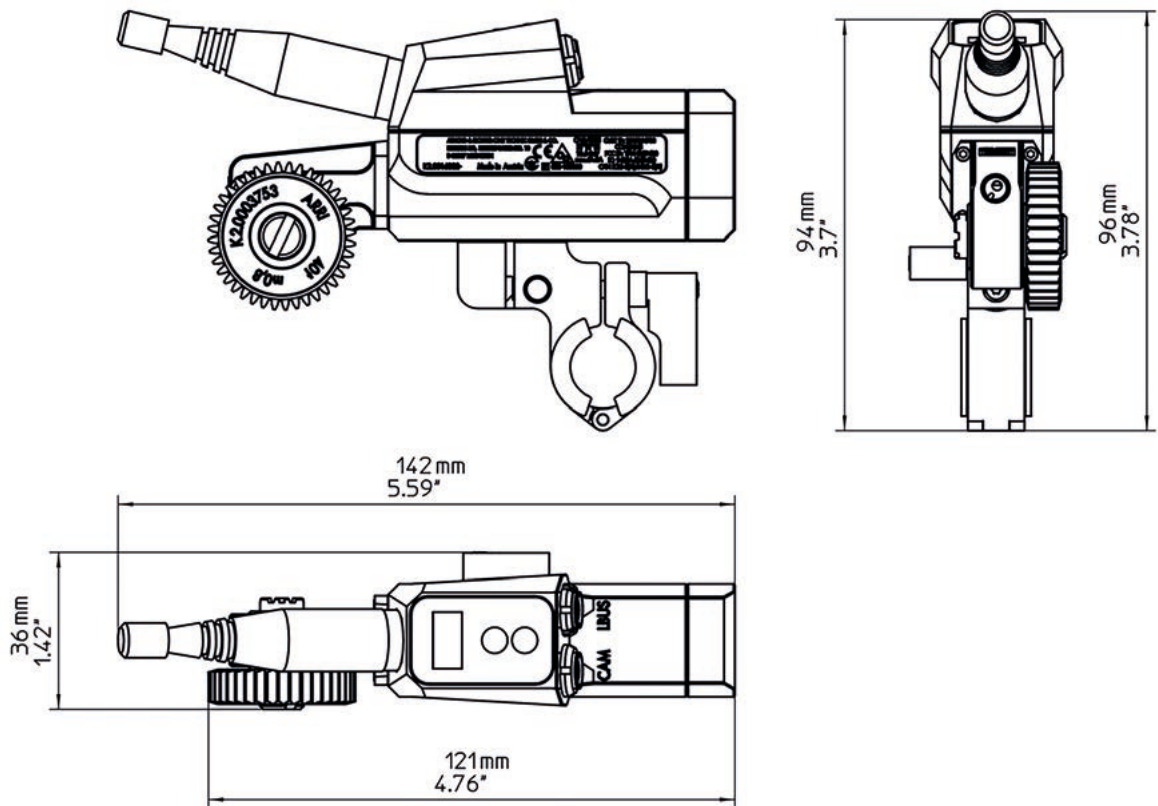

Weight

Weight of cforce mini RF: 237g/8,4oz

(including cforce mini RF motor unit, cforce mini gear m0.8, 40t and cforce mini clamp console 19/15mm)

10.4 Pinouts

The cforce mini RF motor contains one LBUS connector (Lemo 4 pin) and one CAM connector (Lemo 7 pin).

LBUS

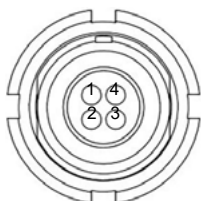

- 1 GND
- 2 CAN-L
- 3 V-BAT
- 4 CAN-H

CAM Connector

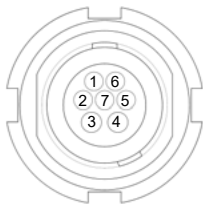

- 1 CAM If1 (CAN RS232 RX)
- 2 CAM If2 (CAN1-L)
- 3 GND
- 4 +V-BAT
- 5 CAM If3 (CAN RS232 TX)
- 6 CAM If4 (CAN1-H)
- 7 Cable ID

10.5 Part Numbers

cforce mini RF Basic Set 2

The cforce minbi RF Basic Set 2 (KK.0040345) includes:



K2.0016802

cforce mini RF motor unit
(including K2.0002007 Outdoor Antenna (straight))



K2.0036610

cforce mini Clamp Console 2 19/15mm
(including K2.0038503 cforce mini Clamp Insert 2 15mm)



K2.0003753

cforce mini gear m0.8, 40t

NOTICE

The cforce mini RF Basic Set does not include any LBUS or CAM cables. LBUS cables are available in various lengths and need to be ordered separately.

Gear for cforce and cforce mini RF

	K2.72108.0	CLM-4/cforce Gear m0.8/32p, 50t ARRI/Zeiss focus/iris/ zoom, Panavision focus, Fujifilm PL focus/ iris/zoom
	K2.0006363	cforce mini gear m0.6, 56t (Fujinon ENG focus/ zoom)
	K2.0006365	cforce mini gear m0.5, 64t (Canon ENG focus/ zoom)
	K2.0006367	cforce mini gear m0.4/64p, 80t (Pan. iris, Fujinon ENG iris, Canon ENG iris)
	K2.0006370	cforce mini gear 48p, 60t (Panavision zoom)
	K2.0006372	cforce mini gear m0.8, 40t, 25mm

Part numbers of compatible antennas

Radial/Larsen	K2.0002007	Dipole / Reverse SMA
Proant	K2.0001996	Dipole / Reverse SMA

Cable and Accessories

The following accessories are compatible with the cforce mini RF

K2.00xxxxx	ALL LBUS Cables
K2.0007318	Cable LCS (5p) – LBUS (0.8m/2.6ft)
K2.0015754	Cable CAM (7p) – RS (0.3m/1ft)
K2.0015755	Cable CAM (7p) - EXT (16p) (0.88m/2.6ft)
K2.0015756	Cable CAM (7p) - EXT (6p) (0.6m/2ft)
K2.0015757	Cable CAM (7p) - LANC/D-Tap (0.6m/2ft)
K2.0015758	Cable CAM (7p) - RED CTRL/D-Tap (0.6m/2ft)
K2.0015759	Cable CAM (7p) - ENG (12p) (0.3m/1ft)
K2.0015760	Cable CAM (7p) – LBUS (0.5m/1.6ft)
K2.0018814	Cable CAM (7p) - Sony Venice/G55 CTRL/D-Tap (0.6m/2ft)
K2.0018813	Cable CAM (7p) - D-Tap (0.5m/1.6ft)
K2.0025027	Cabel CAM (7p) – LBUS (0.3m/1ft)
K2.0034580	Cabel CAM (7p) –LCS (5p) (0.8m/2.6ft)
K2.0047268	Cabel CAM (7p) – Sony Remote (8p)/D-Tap (0.8m/2.6ft)
K2.0023832	Cabel CAM (7p, f) – CAM (8p, m) (0.3m/1ft)

11 ARRI Service Contacts

Please see the current list of service partners at [service contacts](#)



Arnold & Richter Cine Technik GmbH & Co.
Betriebs KG
Herbert-Bayer-Str. 10
80807 Munich
Germany
+49 89 3809 2121
Business hours:
Mo. - Fr. 09:00 - 17:00 (CET)
service@arri.de

ARRI Cine + Video Geräte Ges. m. b. H.
Pottendorferstraße 23-25/3/2/1
1120 Vienna
Austria
+43 1 8920107 30
Business hours:
Mo. - Fr. 09:00 - 17:00 (CET)
service@arri.at

ARRI CT Limited / London
2 Highbridge, Oxford Road
UB8 1LX Uxbridge
United Kingdom
+44 1895 457 000
Business hours:
Mo. - Thu. 09:00 am - 5:30 pm (GMT)
Fr. 09:00 am - 5:00 pm (GMT)
service@arri-ct.com

ARRI Inc. / West Coast
3700 Vanowen Street
CA 91505 Burbank
USA
+1 818 841 7070
Business hours:
Mo. - Fr. 09:00 am - 05:00 pm (PT)
service@arri.com

ARRI Inc. / East Coast
617 Route 303
NY 10913 Blauvelt
USA
+1 845 353 1400
Business hours:
Mo. - Fr. 08:00 am - 05:30 pm (EST)
service@arri.com

ARRI Canada Limited
76 Six Point Road
Etobicoke, ON M8Z 2X2
Canada
+1 416 255 3335
Business hours:
Mo. - Fr. 08:30 am - 05:00 pm (EDT)
service@arri.com

ARRI Australia Pty Ltd
Suite 2, Building B, 12 Julius Ave
NSW 2113 North Ryde
Australia
+61 2 9855 4305
Business hours:
Mo. - Fr. 08:00 am - 05:00 pm (AEST)
service@arri.com.au

ARRI Asia Pte. Ltd.
164 Kallang Way, #03-01
349248 Singapore
Singapore
+65 6230 9488
Business hours:
Mo. - Fr. 9:00 - 18:00 (CST)
service@arri.asia

ARRI China (Beijing) Co. Ltd.
Chaowai SOHO Tower C, 6/F, 0628/0656
Chaowai Dajie Yi 6
Beijing
China
+86 10 5900 9680
Business hours:
Mo. - Fr. 09:00 am - 06:00 pm (CST)
service@arri.cn

ARRI Hong Kong Limited
26/F Gravity, 29 Hing Yip Street
Kwun Tong
Hong Kong
P. R. China
+852 2571 6288
Business hours:
Mo. - Fr. 09:00 am - 06:00 pm (HKT)
service@arri.asia

ARRI Japan Kabushiki Kaisha
Service
Haneda Innovation City Zone K210, 1-1-4
Hanedakuko, Ota-Ku
144-0011 Tokyo
Japan
+81 3 6635 3750
Business hours:
Mo. - Fr. 10:00 - 18:00 (JST)
info@arri.jp

ARRI Korea Limited
42, World Cup buk-ro 1-gil
Mapo-gu
04031 Seoul
Korea
+82 (0)70 4419 6401
Business hours:
Mo. - Fr. 9:00 - 18:00 (KST)
service@arri.kr

ARRI Brasil Ltda
Rua Clodomiro Amazonas, 1158 - Lojas 45 e 46,
Vila Nova Conceição
04537-901 São Paulo
Brazil
+55 1150419450
Business hours:
Mo. - Fr. 09:00 am - 05:30 pm (BRT)
arribrasil@arri.com

LINKA İthalat İhracat ve Diş Tic.
Distributor
Maslak Mah. AOS 55. Sokak 42 Maslak A Blok
SİTESİ
NO: 2 İÇ KAPI NO: 1
Sarıyer, İstanbul
Turkey
+90 2123584520
Business hours:
Mo. - Fr. 09:00 - 18:00 (EET)
service@linkgroup.com.tr

CINEOM Broadcast DMCC.
HDS Business Center, Unit No. 3503, Floor No.
35 Cluster M
Jumeirah Lake Towers
Dubai
Dubai, UAE
+971 (0) 45570477
Business hours:
Sa. - Th. 10:00 am- 06:00 pm
arriservice.me@cineom.com

CINEOM Broadcast India Pvt. Ltd.
C-4, Goldline Business Centre
Link Rd. Malad West
400 064 Mumbai
India
+91 (0)22 42 10 9000
Business hours:
Mo. - Sa. 10:00 am - 06:00 pm (IST)
arrisupportindia@cineom.com

ARRI 