

# CCM-1 Camera Control Monitor

OPERATING MANUAL

August 2023 • 1.0 • English





## Imprint

© 2023 Arnold & Richter Cine Technik GmbH & Co. Betriebs KG. All rights reserved.

The device contains proprietary information of Arnold & Richter Cine Technik GmbH & Co. Betriebs KG; it is provided under a license agreement containing restrictions on use and disclosure and protected by copyright law. Reverse engineering of the software is prohibited.

No part of this publication may be used for distribution, reproduction, transmission, transcription, storage in a data retrieval system, or translated into any language in any form by any means without the prior written permission of Arnold & Richter Cine Technik GmbH & Co. Betriebs KG.

If you are downloading files from our web pages for your personal use, make sure to check for updated versions.

ARRI cannot take any liability whatsoever for downloaded files, as technical data are subject to change without notice.

Due to continued product development the information in this document may change without notice. The information and intellectual property contained herein is confidential between ARRI and the client and remains the exclusive property of ARRI. If you find any problems in the documentation, please report them to us in writing. ARRI does not warrant that this document is flawless.

AMIRA, ALEXA, ALEXA XT, ALEXA SXT, ALEXA LF, ALEXA Mini and ALEXA Mini LF are trademarks or registered trademarks of Arnold & Richter Cine Technik GmbH & Co. Betriebs KG. All other brands or products are trademarks or registered trademarks of their respective holders and should be treated as such.

Original version.

### **For Further Assistance**

Arnold & Richter Cine Technik GmbH & Co. Betriebs KG

Herbert-Bayer-Str. 10

D-80807 Munich

Germany

E-mail: [service@arri.com](mailto:service@arri.com)

Website: [www.arri.com/en/technical-service](http://www.arri.com/en/technical-service)

# Content

Imprint .....	3
<b>1 About this document .....</b>	<b>5</b>
<b>2 About this Product .....</b>	<b>6</b>
2.1 Introduction .....	6
2.2 Intended Use .....	6
2.3 Identification .....	6
2.4 Environmental Conditions .....	6
2.5 Technical Data .....	7
2.6 Dimensional Drawing .....	8
2.7 Scope of Delivery and Warranty .....	8
2.8 Approval Information .....	9
<b>3 Safety Instructions .....</b>	<b>11</b>
3.1 General Safety Instructions .....	12
<b>4 Product overview .....</b>	<b>15</b>
Layout .....	15
<b>5 Mounting and Assembly .....</b>	<b>16</b>
5.1 Power Supply and Connect .....	16
5.2 Attachment of Accessories .....	16
5.3 Sunhood .....	17
<b>6 Basic Operation .....</b>	<b>18</b>
6.1 ARRI Camera Controls .....	18
6.1.1 Classic Menu .....	18
6.1.2 Home Screen .....	18
6.1.3 Interactive Overlays .....	18
6.1.4 Playback Control .....	19
6.2 PageOS Overview .....	19
6.2.1 General Layout .....	19
6.2.2 Basic Navigation .....	20
6.2.3 Pages .....	20
6.2.4 Settings .....	21
<b>7 Cleaning, Maintenance and Repair .....</b>	<b>23</b>
<b>8 Transportation, Storage and Disposal .....</b>	<b>24</b>
<b>9 ARRI Service Contacts .....</b>	<b>25</b>

# 1 About this document

This operating manual is aimed at everyone involved in using the device. It provides directions on how to operate it safely and as intended. To ensure safe and correct use, all users must read the operating manual before using the device for the first time.

This operating manual is an essential part of the device. It must be easily accessible and in close proximity to the device so that users can use it as a reference anytime.

The separate user manual contains more detailed information about the features and functionalities of the device. Please visit the website [www.arri.com](http://www.arri.com) to download the user manual.

Keep the operating manual, the user manual and all other operating and assembly instructions belonging to the device in a safe place for future reference and possible subsequent owners.

For useful information in addition to these manuals please have a look at the [ARRI learn & help](#) section on the [ARRI website](#).

The ARRI Academy courses provide unrivalled insights into the full possibilities of working with ARRI camera systems, lenses, lighting systems and accessories.

Our advanced service training courses are designed to transfer detailed knowledge about how to service and repair all types of ARRI products and give you permanent access to detailed Service instructions, special tools and spare parts. To learn more, please visit [ARRI academy](#) or contact [academy@arri.de](mailto:academy@arri.de).



[www.arri.com/ccm-1](http://www.arri.com/ccm-1)

## Document Revision History

Document ID: D45 1000 7638

Version	Release	Date	Note
1.0	K11303	July 2023	First Release

## 2 About this Product

### 2.1 Introduction

The CCM-1 is a 7" onboard monitor that provides full camera control and menu access for the ALEXA 35 and ALEXA Mini LF. The CCM-1 is ideally suited to numerous production types and applications.

For camera operators who prefer to judge framing and exposure with an onboard monitor rather than a viewfinder, the CCM-1 is an easy choice.

### 2.2 Intended Use

The CCM-1 is a camera control monitor for professional use in broadcast and film production environments.



#### NOTICE

All versions of the CCM-1 are intended exclusively for professional use. It must be used only by skilled personnel. Read and understand the operating manual and the user manual before use.

Use the product only for the purpose described in this document. Always follow the safety instructions and system requirements for all equipment involved. ARRI assumes no liability for damages or changes that are caused by improper use. You are not allowed to modify the device.

### 2.3 Identification



The CCM-1 serial number is located on the product label in the lower center of the CCM-1. The serial number consists of the last 4 digits of the product number K2.00YYYYYY-1234 (here: 1234).

### 2.4 Environmental Conditions

The CCM-1 should only be used and stored under certain environmental conditions. Check the following conditions before commissioning and operation:

<b>Permissible Operating Temperature</b>	32° F to 113° F (0° C - 45° C)
<b>Permissible Storage Temperature</b>	-4° F to 158° F (-20° C - 70° C)
<b>Permissible Humidity</b>	0 - 95% RH non condensing

## 2.5 Technical Data

### Mechanical Specification

<b>Dimensions (H x W x D)</b>	4.72 x 7.36 x 1.15 in (120 x 187 x 29 mm)
<b>Weight</b>	0.65 lbs (0,3 kg)
<b>Material</b>	Aluminum alloy
<b>Arm mounting</b>	4x ARRI Pin-Lock1/4" mounting points (Top, Bottom, Rear, Right Side)
<b>Hood mounting</b>	Friction attach

### Electrical Specification

<b>Power input</b>	PWR + VF connector
<b>Power consumption</b>	up to 20 W
<b>Firmware requirement</b>	Compatible with TBD firmware or later

### Optical Specification

<b>LCD Type</b>	Thin Film Transistor Liquid Crystal Display (TFT LCD) with LED backlight
<b>Resolution</b>	1920 x 1200
<b>Pixel density</b>	322 ppi
<b>Active screen size</b>	3.72 x 5.95 in (95 x 151 mm)
<b>Refresh rate</b>	30Hz - 60Hz (Locked to incoming frame rate between 7.5fps and 60fps)
<b>Response time</b>	25 ms
<b>Contrast</b>	1.200 : 1
<b>Screen luminance</b>	~1300 cd/m2 (max.) Backlight Dimming 100% to 0%
<b>Color depth</b>	8+2FRC
<b>Luminance uniformity (typical)</b>	89%
<b>Colors (typical)</b>	96% DCI-P3
<b>Viewing angle</b>	160° all axes
<b>Display orientation</b>	Landscape, 180° rotation

### User Interface

<b>Touch</b>	pCap Multi-Touch
<b>Buttons</b>	Menu
	User Button 1-4
	Back
	Power
	Lock Slider
	Joystick

## 2.6 Dimensional Drawing

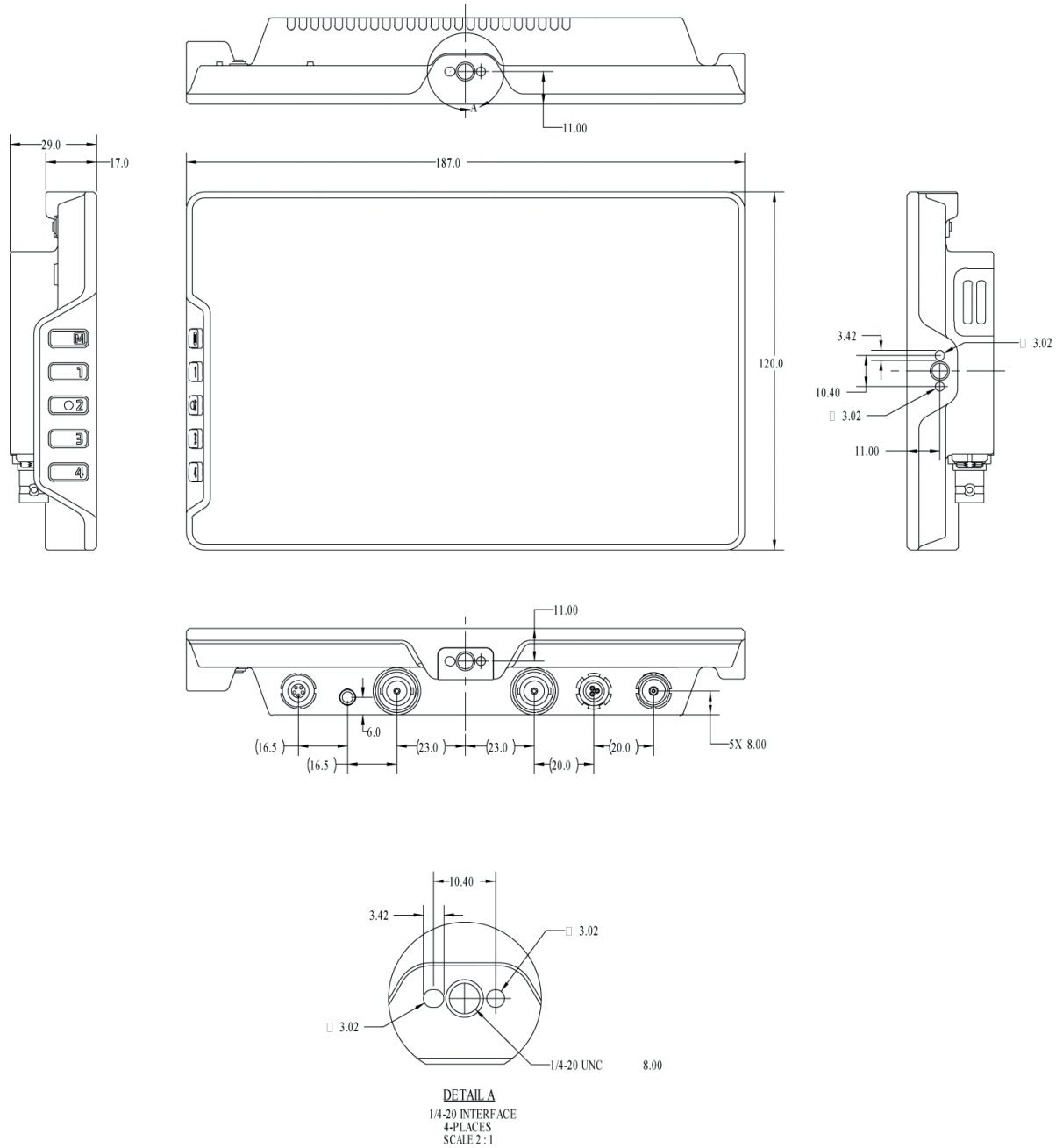

All Dimensions in mm.

## 2.7 Scope of Delivery and Warranty



### NOTICE

The packaging consists of recyclable materials. For the sake of the environment, dispose of the packaging material at a suitable disposal site. Always store, ship and dispose according to local regulations. ARRI is not liable for consequences from inadequate storage, shipment or disposal.

On delivery, please check if package and content are intact. Never accept a damaged or incomplete delivery.



**Delivery**

A complete Camera Control Monitor CCM-1 Set KK.0048851 includes:

- 1x K2.0048523 CCM-1 with Foldable Sunhood, Screen Protector
- 1x K2.0048394 Monitor Arm for Camera MAC-1
- 1x K2.0023943 Cable VF (0.5 m / 1.5 ft)
- 1x K2.0001637 Cable RS – RS/PWR IN (0.5 m / 1.5 ft)

**Warranty**

For scope of warranty, please ask your local ARRI Service Partner. ARRI is not liable for consequences from inadequate shipment, improper use or use of third-party products.

**2.8 Approval Information**

The CCM-1 is approved for use in many countries, including European Union, USA, UK, Canada, China, Japan, Australia, New Zealand, and Thailand.

The import and use in other countries may be subject to legal, official or regulatory requirements and regulations. It is the importer's or the user's responsibility, prior to importation or use, to inform themselves of the applicable legal, regulatory and administrative requirements and regulations and to ensure compliance with these requirements and regulations. This includes the applying for and obtaining of all necessary approvals or registrations.

As far as reasonable and legally possible, ARRI will support requests in relation to such applications by providing technical documents or declarations. As an importer or user, you confirm that you are familiar and comply with the legal, regulatory, and administrative requirements and regulations that apply in the countries to which you ship or use the products. You further confirm that you will arrange for any necessary registrations, enrollments, or authorizations that are required in such countries.

You release ARRI from all obligations resulting from any legislative, regulatory, or administrative requirements regarding import or use of the products, except in countries where ARRI has obtained a registration or certification. You agree to indemnify, defend, and hold ARRI harmless from any and all claims, damages, losses, liabilities, costs, and expenses (including reasonable fees of attorneys and other professionals) that may arise out of a demand on ARRI in connection with your obligations mentioned above.

**EU Declaration of Conformity**

Brand Name: ARRI  
 Product Description: Camera Control Monitor-1  
 CCM-1

The product conforms to the specifications of the following European directives:

- Directive 2014/30/EU of the European Parliament and the Council of 26 February 2014 on the harmonization of the laws of the Member States relating to electromagnetic compatibility
- Directive 2011/65/EU of the European Parliament and the Council of 8 June 2011 on the restriction of the use of certain hazardous substances in electrical and electronic equipment and the Commission Delegated Directive (EU) 2015/863 of March 31, 2015.

The compliance with the requirements of the European Directives has been verified by applying the following standards:

- EN 55032:2015 +AC:2016 +A1:2020 +A11:2020 ; EN 55035:2017 +AC:2019 +A11:2020 ;
- EN IEC 63000:2018

The manufacturer bears sole responsibility for issuing this declaration of conformity.

## UK Declaration of Conformity



Brand Name: ARRI  
Product Description: Camera Control Monitor-1  
CCM-1

The product conforms to the specifications of the following United Kingdom regulations:

- The Electromagnetic Compatibility Regulations 2016
- The Restriction of the Use of Certain Hazardous Substances in Electrical and Electronic Equipment Regulations 2012

The compliance with the requirements of the United Kingdom regulations was proved by the application of the following standards:

- EN 55032:2015 + A11:2020; EN 55035:2017 + A11:2020;
- EN IEC 63000:2018

The manufacturer bears sole responsibility for issuing this declaration of conformity.

## FCC Class A Statement

### FCC Class A Statement

Note: This equipment has been tested and found to comply with the limits for a Class A digital device, pursuant to Part 15 of the FCC Rules. These limits are designed to provide reasonable protection against harmful interference when the equipment is operated in a commercial environment. This equipment generates, uses, and can radiate radio frequency energy and, if not installed and used in accordance with the instruction manual, may cause harmful interference to radio communications. Operation of this equipment in a residential area is likely to cause harmful interference in which case the user will be required to correct the interference at his own expense.

Caution: changes or modifications to the product not expressly approved by the party responsible for compliance could void the user's authority to operate the equipment.

## Industry Canada Compliance Statement

Complies with CAN ICES-003(A)/NMB-003(A).

## Australia and New Zealand Compliance



Brand Name: ARRI  
Product Description: Camera Control Monitor-1  
CCM-1

## South Korea Compliance

Pending.

## Taiwan Compliance

Pending.

### 3 Safety Instructions

This safety information is in addition to the specific operating instructions in general and must be strictly observed for safety reasons. Read and understand all safety and operating instructions before you operate or install the device. Retain all safety and operating instructions for future reference. Always follow the instructions in this and all documents supplied with the device to avoid injury to yourself or others and damage to the device or other objects.

Assembly and operation should only be carried out by trained staff familiar with the device. Only use the tools, materials and procedures recommended in this document. For the correct use of other equipment, see the manufacturer's instructions.

#### Structure of Safety and Warning Messages

These instructions use safety instructions, warning symbols and signal words to draw your attention to different levels of risk:



#### DANGER

**DANGER** indicates an imminent danger. If not avoided, death or serious injury will result.

Always follow the recommended measures to avoid this hazardous situation.



#### WARNING

**WARNING** indicates a possibly imminent danger. If not avoided death or serious injury may result.

Always follow the recommended measures to avoid this potentially hazardous situation.



#### CAUTION

**CAUTION** indicates a potentially imminent danger. If not avoided, slight or minor injuries may result.

Always follow the recommended measures to avoid this potentially hazardous situation.



#### NOTICE

**NOTICE** indicates a potentially harmful situation. If not avoided, the equipment or something in its surrounding may be damaged.

Always follow the recommended measures to avoid this situation.

#### HINT

Not relevant to safety, **HINT** provides additional information to clarify or simplify a procedure.

### Warning Symbols and Product Labels



General warning sign



Warning of electrical voltage



Warning of hot surfaces



Warning of sharp element



Warning of the risk of crushing



Warning of obstacles on the ground



Please read all instructions carefully before using the product for the first time.



Direct Current symbol found on electronics requiring or producing DC power.

## 3.1 General Safety Instructions



### WARNING

#### Operation of the CCM-1 in Case of Obvious Damage

Risk of electric shock and fire hazard caused by short circuit.

- ▶ Never use the product if electrical lines or housing are visibly damaged.
- ▶ Only use the type of power source indicated in the manual.
- ▶ Always grip the power plug to unplug the power cable.
- ▶ Never operate the product in areas with humidity above operating levels.
- ▶ Never expose it to water or moisture.
- ▶ Do not get the product wet.
- ▶ Do not lay cables over sharp edges (e.g. sheet metal, profile or other cut edges). Damaged cables can cause electric shock, short circuit or fire.
- ▶ Do not remove or deactivate any safety measures from the product (incl. warning stickers or paint marked screws).
- ▶ Do not try to repair the product. Repairs may only be carried out by authorized ARRI service partners.



### WARNING

#### Falling System Parts

Do not built up or assemble the CCM-1 the wrong way. It can fall down and cause serious injuries and damage to the product or property.

- ▶ Installation and operation must only be carried out by approved persons who know the product. Obey the accident prevention regulations.
- ▶ Never put the product on a not stable trolley or hand truck, stand, tripod, bracket, table or any other not stable support device.
- ▶ Always place the product on dedicated support devices.
- ▶ Secure the product and its accessories against falling and tipping over. Obey the general and local safety regulations.
- ▶ Always use a suitable safety rope when you use the product above floor level (i.e. on cranes).



## WARNING

### Connected Cable on the Floor

Risk of injury caused by tripping, falling or slipping over connected cables.

- ▶ Always properly secure cables connected to the product and accessories.
- ▶ Always install cables that they cannot be tripped over.
- ▶ If necessary, use a cable duct or secure the cables with adhesive tape.
- ▶ Always disconnect the cables from the product and accessories before moving.



## CAUTION

### Hot Surfaces

During extended operation and / or operation at high ambient temperatures, the surface of the CCM-1 can get hot. Direct sunlight can result in housing temperatures above 60° C (140° F).

- ▶ Always use an approved mount to fasten the CCM-1 to the system.
- ▶ Never hold the CCM-1 with bare hands for a long time.
- ▶ Do not touch the monitor surface with bare hands. It can get hot during operation.
- ▶ Do not put covers on the CCM-1 while it is powered. Make sure cooling fins are not obstructed and airflow around cooling fins is free.
- ▶ Do not put the CCM-1 near any heat sources during operation.
- ▶ At ambient temperatures above 25° C (77° F), prevent the CCM-1 from being exposed to direct sunlight.



## CAUTION

### Use of the CCM-1 or CCM-1 Accessories in a Humid Environment and with Condensation

When you move the device and the accessories from a cool to a warm location or when the device is used in a damp environment, condensation may form inside the device, and on internal or external electrical connections. Do not operate the device while condensation is present. It bears risk of electric shock and/or fire caused by a short circuit.

- ▶ Do not operate the device and accessories when condensation occurs.
- ▶ When you move the device and accessories from a cool to a warm environment, wait for some time for the components to warm up.
- ▶ Find a warmer storage location to decrease the risk of condensation.



## CAUTION

### Tripping due to Inattention

Risk of injury and damage to the CCM-1.

- ▶ Always pay attention to the surroundings while using the product.



## CAUTION

### Broken Cover Glass

Risk of cutting fingers.

- ▶ Do not hit the cover glass.
- ▶ Use protective gear in case of broken cover glass.



## NOTICE

### Drop of the product caused by incorrect assembly on recommended third-party accessories

Risk of damage to the CCM-1

- ▶ Installation and operation must be done by trained personnel.
- ▶ Always read and understand the operating instructions of third-party accessories before you mount recommended the accessories (such as pan bar arm).
- ▶ Always use the tools specified by the manufacturer.



## NOTICE

### Parts Loosening Caused by External Vibration

Risk of damage to the CCM-1.

- ▶ Do not use in places where the product is subject to vibration.
- ▶ Do not store in places where the product is subject to vibration.



## NOTICE

### Danger from High Frequency Radiation

Risk of damage to the CCM-1

- ▶ Do not use in places where the product is exposed to high frequency radiation.
- ▶ Do not store in places where the product is exposed to high frequency radiation.



## NOTICE

### Use of Unauthorized Accessories and Spare Parts

Risk of damage to the CCM-1

- ▶ Do not use any accessories and spare parts that are not recommended by ARRI. They may damage any connected products and invalidate the warranty.

## 4 Product overview

### Layout

#### Back View

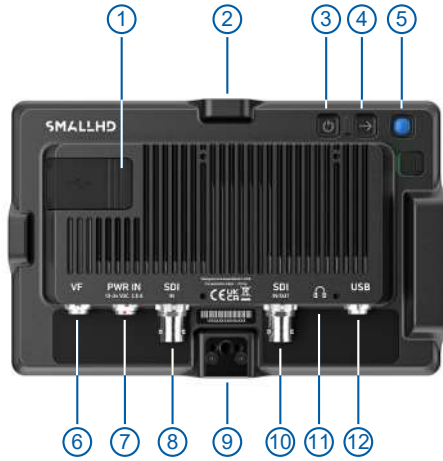

- 1 USB slot
- 2 ARRI Pin-Lock 1/4"
- 3 Power button
- 4 Back button
- 5 Joystick
- 6 VF
- 7 PWR IN
- 8 SDI IN
- 9 2x ARRI Pin-Lock 1/4"
- 10 SDI IN/OUT
- 11 Headphone
- 12 USB Locking connector 5-pin

#### Left View

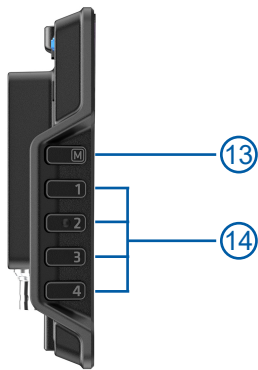

- 13 Menu button
- 14 User button 1-4

#### Right View



- 15 ARRI Pin-Lock 1/4"

## 5 Mounting and Assembly

### 5.1 Power Supply and Connect

#### Power

The CCM-1 can be supplied via a VF cable or a power cable.

When powering the CCM-1 via a VF Cable the maximum brightness of the monitor is limited to 100 nits.

When powering the CCM-1 via a power cable the maximum brightness of the monitor is 1.300 nits.

1. Switch off the power supply.
2. Connect the Coaxpress cable with the SDI input connector (8) or the power cable with the power input (7).
3. Switch on the power supply and the CCM-1 with the power button (3).
4. Press the power button (3) to switch off the CCM-1.

#### Signal

The CCM-1 accepts video signals via 3G-SDI up to 1080p60.

### 5.2 Attachment of Accessories

#### Mounting Options

There are four ARRI Pin-Lock 1/4" mounting points (1 x top, 1 x bottom, 1 x rear, 1 x right side) to mount the CCM-1 to a camera or a rig.

#### ARRI MAC-1

**CAUTION! The housing of the product gets warm during operation. Always use an approved mount like the ARRI MAC-1 to mount the product to the system.**

The CCM-1 is shipped with an ARRI MAC-1 monitor arm. The MAC-1 monitor arm connects to the mounting points (2, 9, 15). Please observe the orientation of the MAC-1 monitor arm: The marking "Display side" on the front of the monitor arm must face to the display side of the monitor.





### 5.3 Sunhood

This foldable sunhood for the Camera Control Monitor CCM-1 can be mounted to the CCM-1 without any tools, the side flaps and the top flap hold together magnetically. The outside material is strong and durable, the inside microfiber material protects the display and prevents reflections. The sunhood protects the display of the CCM-1 even when folded.



## 6 Basic Operation

### 6.1 ARRI Camera Controls

#### 6.1.1 Classic Menu



The CCM-1 offers access to the complete camera menu for access to all camera settings.

The menu can be controlled with touch or physical keys (13) and offers the same, intuitive layout as the MVF-2.

#### 6.1.2 Home Screen



The familiar HOME screen has been updated for the larger CCM-1 display and shows all relevant camera information at a glance. Touching one of the five main exposure parameters will take users to a live image where they can make adjustments with a real-time preview. On the left, an overview of the user button assignments are shown.

#### 6.1.3 Interactive Overlays



##### Status Components

A live image with interactive status components allows quick access to the most frequently adjusted settings. Changes occur in real time and can be viewed live instead of changing between a menu and the image.

## 6.1.4 Playback Control

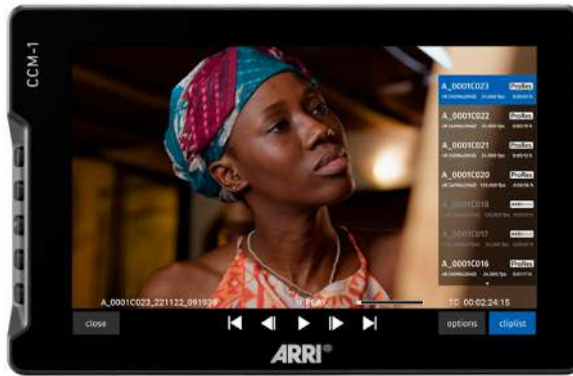

Improved playback control is accessed via the menu or a user button. An extended clip list can be viewed during playback and includes a handy metadata display.

## 6.2 PageOS Overview

The PageOS interface allows users to configure and assign specific image-analyzing tools and / or features to up to eight customizable pages. Users can access those tools by navigating to the corresponding page on the monitor, instead of enabling or disabling features individually.

### 6.2.1 General Layout

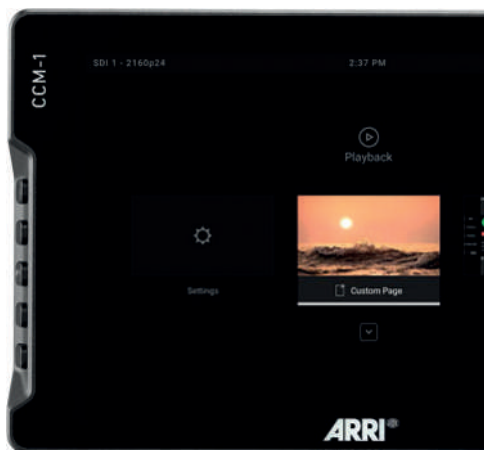

#### Pages View

The 'Pages View' offers a zoomed-out perspective of all configured pages, allowing organization and naming to ensure the most efficient overall setup.

#### Monitor Settings

The settings page will allow you to adjust a wide range of global monitor settings.

## 6.2.2 Basic Navigation



### Touchscreen

PageOS has an easy-to-navigate touchscreen that works just like your smartphone.

- Pinch to zoom
- Swipe left and right between custom pages
- Slide your finger down for a view of all your preset pages
- Swipe all the way left to access your deep settings menu (Calibration, Profiles, etc)

### Joystick

Use the joystick (5) to navigate the Pages menu:

- LEFT or RIGHT -- to change Pages
- DOWN -- Enter Page View mode
- UP -- Zoom or Exit Page View mode

Button press or depress selects highlighted items.

### Back Button

Click the back button (4) to close or navigate back / exit.

### User Buttons

Press and hold to program these custom user buttons (14) as shortcuts.

## 6.2.3 Pages



### Add

To create a new page from either a fresh workspace, a premade template, or a specific utility, navigate to the right-hand side of the Pages View. Select the New Blank Page option and then choose which type of page you would like to add or create a custom one from scratch.

### Delete

Zoom out and navigate to the page you would like to delete push down with your joystick (5) to select the delete option, or if using touch just press the delete button and then confirm.

### Add New Tool to a Page

- Tap your screen while on any page to reveal the toolbar.
- Press the plus sign that appears on the left side of the page.
- Select the tool you want to add to that page.

You will be presented with an option to add to that specific page or to add the tool to all pages, if you choose to add it to all pages that tool will be present on every single page, whereas if you just select single page it will be confined to the page you are currently on.



## Adjusting Tools

Tap your screen while on any page to reveal the toolbar. Then select the tool you want to activate. To adjust the custom settings of that tool press the arrow that appears next to the name of the tool, this will take you to a submenu that will show your adjustment options for that specific tool.

## 6.2.4 Settings

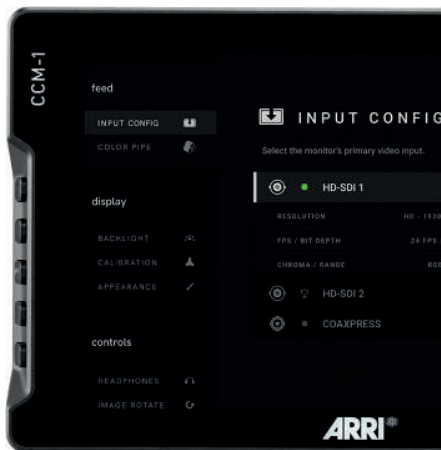

### FEED

- **Input Config**  
Select an input to display the image present on SDI 1, SDI 2 or VF.

### DISPLAY

- **Backlight**  
Select a backlight level that suits your viewing environment to maximize contrast and viewability.
- **Calibration**  
Calibration ensures chrominance and luminance accuracy that can be relied upon for critical color decisions.
- **Appearance**  
Apply sharpening to the video data, if desired.

### CONTROLS

- **Volume**  
Adjust the audio output level for the headphone jack (11).
- **Image Rotate**  
Image Rotate options enable upside-down mounting -- or enable Mirroring for when the monitor must face the subject.
- **Interlace**  
These options control how interlaced footage is displayed.

### CAPTURE

- **Image Capture**  
Configure the Image Capture tool to help facilitate shot matching or for automatic thumbnail creation upon pressing Record.
- **Image Gallery**  
Browse the Image Gallery to review the images on your removable media.

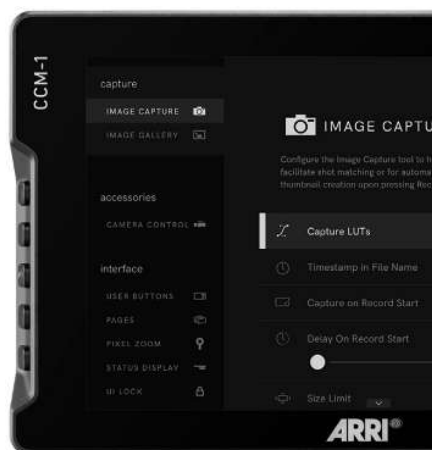

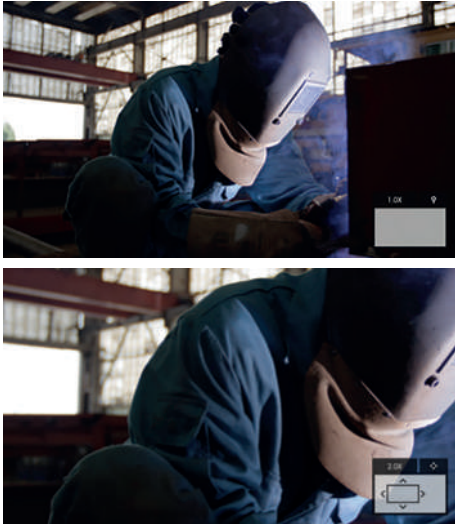

## INTERFACE

- **Pixel Zoom**  
Configure the default zoom levels for Pixel Zoom to 'punch in' to a desired amount when spot-checking a particular shot.
- **Status Display**  
Enable and configure the Status Display to get info on various monitoring-related data such as battery life and frames per second.
- **UI Lock**  
Once enabled, pressing and holding on the touchscreen for five seconds will lock the UI. Repeating the process will unlock the UI.
- **Language**  
Change the language of the internal menu system.

## USER

- **Backdrop**  
Enable a customizable backdrop for when the monitor is not displaying a signal.
- **Power**  
Power-related options such as auto recovery.
- **Date Time**  
Setting the correct Date & Time will ensure that captured images get an accurate timestamp.
- **Monitor ID**  
Set a custom name for your monitor, to make it more easily recognizable.
- **Profiles**  
Save or load the entire monitor's configuration to a USB Drive, great for keeping consistent settings across several monitors.

## SYSTEM

- **Firmware**  
Firmware can be updated by inserting USB Thumb Drive with a compatible update file.

For the latest firmware download visit: [www.arri.com/sups](http://www.arri.com/sups)

- **Factory Reset**  
Reset the monitor settings to its original factory settings, with the option to clear registration and calibration.

## 7 Cleaning, Maintenance and Repair



### NOTICE

#### Improper Cleaning Procedure

Risk of damage of surfaces.

- ▶ Only use the cleaning agents specified in this section.
- ▶ Do not use any strong or aggressive cleaning detergents like Methanol, Acetone, Benzine or acids. These chemicals may dissolve imprinted labels or the paint on the housing and damage highly polished surfaces.
- ▶ During cleaning of the device, always make sure that protective covers are in place.
- ▶ Do not moisten connectors when cleaning the device.
- ▶ Avoid touching any connector pins when cleaning the device.
- ▶ Avoid wiping dry connector pins with a dry cloth, especially if the surface is not clean.
- ▶ Avoid wiping connector pins without air blow dusting first. If particles or connector pins are electrostatically charged, it may improve dusting efficiency to use deionized air.
- ▶ Compressed air should not be used on the housing.

#### Recommended Cleaning Agents

- Water
- Glass Cleaner
- Isopropyl Alcohol

Area	Cleaning Procedure
<b>Housing</b>	Clean the housing, mechanical and electronic accessories with a soft, lint free cleaning cloth and some water or glass cleaner.  Only when really necessary, e.g. to remove residues of camera tape, isopropyl alcohol should be used.
<b>Narrow spaces and gaps</b>	Use a manual air blower, cotton swabs or a soft brush to remove dust particles from narrow spaces, gaps or connectors.
<b>Ventilation channel</b>	Clean the ventilation channel using a vacuum cleaner at low level.



### WARNING

#### Repairs carried out by untrained personnel

Risk of electric shock and fire caused by short circuit.

- ▶ Do not try to repair the device yourself. Repairs may only be carried out by an authorized ARRI service partner.

Only carry out the maintenance and repair work described in this manual.

For any further repairs and maintenance work on the device, please contact an ARRI service partner or [service@arri.de](mailto:service@arri.de).

## 8 Transportation, Storage and Disposal



### NOTICE

#### Improper Packing and Transportation of the CCM-1

Risk of damage to the product.

- ▶ Always follow the specified environmental conditions.
- ▶ Always transport the product and accessories in a suitable case.
- ▶ Always follow the instructions for transport and storage described in this section.

The product and its accessories can be damaged if not transported and stored properly. Please take note of the following guidelines.

#### Transportation Guidelines:

- Remove all accessories from the product.
- Always attach protective caps where applicable.
- Always transport the product in a suitable case.
- Do not subject the product to severe shocks.

#### Storage Guidelines:

- Remove the all accessories.
- Disconnect all cables and power sources from the product.
- Always store the product in a suitable case.
- Do not store the product outside of the specified ambient temperature range.
- Do not store the product in places where it may be subject to extreme temperatures, direct sunlight, high humidity, severe vibration, dust or strong magnetic fields.

#### Disposal



### NOTICE

You can return the product to the manufacturer Arnold & Richter Cine Technik GmbH & Co. Betriebs KG for disposal.

When you dispose third party accessories, please observe the instructions of the relevant manufacturer.

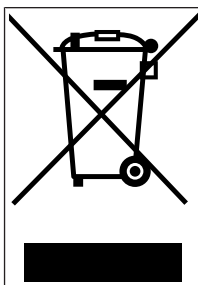

This product falls within the scope of Directive 2012/19 / EU OF THE EUROPEAN PARLIAMENT AND OF THE COUNCIL of June 4, 2012 on waste electrical and electronic equipment (WEEE II).

Accordingly, this product must not be disposed of with household waste. There are the respective country-specific disposal rules that must be observed.



## 9 ARRI Service Contacts

Please see the current list of service partners at [service contacts](#)



Arnold & Richter Cine Technik GmbH & Co.  
Betriebs KG  
Herbert-Bayer-Str. 10  
80807 Munich  
Germany  
+49 89 3809 2121  
Business hours:  
Mo. - Fr. 09:00 - 17:00 (CET)  
service@arri.de

ARRI CT Limited / London  
2 Highbridge, Oxford Road  
UB8 1LX Uxbridge  
United Kingdom  
+44 1895 457 000  
Business hours:  
Mo. - Thu. 09:00 am - 5:30 pm (GMT)  
Fr. 09:00 am - 5:00 pm (GMT)  
service@arri-ct.com

ARRI Inc. / West Coast  
3700 Vanowen Street  
CA 91505 Burbank  
USA  
+1 818 841 7070  
Business hours:  
Mo. - Fr. 09:00 am - 05:00 pm (PT)  
service@arri.com

ARRI Inc. / East Coast  
617 Route 303  
NY 10913 Blauvelt  
USA  
+1 845 353 1400  
Business hours:  
Mo. - Fr. 08:00 am - 05:30 pm (EST)  
service@arri.com

ARRI Canada Limited  
1200 Aerowood Drive, Unit 29  
ON L4W 2S7 Mississauga  
Canada  
+1 416 255 3335  
Business hours:  
Mo. - Fr. 08:30 am - 05:00 pm (EDT)  
service@arri.com

ARRI Australia Pty Ltd  
Suite 2, 12B Julius Ave  
NSW 2113 North Ryde  
Australia  
+61 2 9855 4305  
Business hours:  
Mo. - Fr. 08:00 am - 05:00 pm (AEST)  
service@arri.com.au

ARRI Asia Pte. Ltd.  
164 Kallang Way, #03-01  
349248 Singapore  
Singapore  
+65 6230 9488  
Business hours:  
Mo. - Fr. 9:00 - 18:00 (CST)  
service@arri.asia

ARRI Japan Kabushiki Kaisha  
Service  
Haneda Innovation City Zone K210, 1-1-4  
Hanedakuko, Ota-Ku  
144-0011 Tokyo  
Japan  
+81 3 6635 3750  
Business hours:  
Mo. - Fr. 10:00 - 18:00 (JST)  
info@arri.jp

ARRI China (Beijing) Co. Ltd.  
Chaowai SOHO Tower C, 6/F, 0628/0656  
Chaowai Dajie Yi 6  
Beijing  
China  
+86 10 5900 9680  
Business hours:  
Mo. - Fr. 09:00 am - 06:00 pm (CST)  
service@arri.cn

ARRI ASIA Limited  
41/F One Kowloon, 1 Wang  
Yuen Street Kowloon Bay  
Hong Kong  
P. R. China  
+852 2537 4266  
Business hours:  
Mo. - Fr. 09:00 am - 06:00 pm (HKT)  
service@arri.asia

ARRI Korea Limited  
Kolon Digital Tower 1(#1505-06), 25  
Seongsuil-ro 4 gil, Seongdong-gu  
04781 Seoul  
Korea  
+82 (0)70 4419 6401  
Business hours:  
Mo. - Fr. 9:00 - 18:00 (KST)  
service@arri.kr

ARRI Brasil Ltda  
Avenida Ibirapuera 2907 – Cj. 421, Indianópolis  
04029-200 São Paulo  
Brazil  
+55 1150419450  
Business hours:  
Mo. - Fr. 09:00 am - 05:30 pm (BRT)  
arribrasil@arri.com

LINKA İthalat İhracat ve Diş Tic.  
Distribütör  
Halide Edip Adivar Mah. Darülaceze Cad.  
No:3 Akın Plaza Kat:5 95-96  
34381 Şişli, İstanbul  
Turkey  
+90 2123584520  
Business hours:  
Mo. - Fr. 09:00 - 18:00 (EET)  
service@linkgroup.com.tr

CINEOM Broadcast India Pvt. Ltd.  
C-4, Goldline Business Centre  
Link Rd. Malad West  
400 064 Mumbai  
India  
+91 (0)22 42 10 9000  
Business hours:  
Mo. - Sa. 10:00 am - 06:00 pm (IST)  
arrisupportindia@cincom.com

CINEOM Broadcast DMCC.  
Unit No. 2109, Jumeirah Bay Tower X2 Cluster X  
Jumeirah Lakes Towers  
P.O Box 414659  
Dubai, UAE  
+971 (0) 45570477  
Business hours:  
Sa. - Th. 10:00 am- 06:00 pm  
arriservice.me@cincom.com



**CCM-1**