

# TRINITY 2 SUP 1.4.1

## Software Update Package 1.4.1

### RELEASE NOTES

Feb. 2023



# 1 Introduction / Change Log

## Introduction

We hereby announce the release of the Software Update Package **SUP 1.4.1** for the RCP-3 and TRINITY 2 head.

This release ensures compatibility of the RCP-3 and the TRINITY 2 head, and it also contains several bug fixes.

## Recommendation

We highly recommend updating your RCP-3 and the TRINITY 2 head to this Software Update Package.

This update is mandatory to ensure overall system performance.

## Change Log

1. Calibration Tolerances in the MGT-2, which led to limitations in the tilt axis, up to and including blocking of the tilt movement. This problem has been solved.
2. Increase resolution of IMU position on the main screen (decimal point).
3. PID Presets for light cameras optimized.
4. Analog Joystick assignment improved.
5. The allowed misalignment to switch the Trinity on as extended to  $\pm 25^\circ$  for Tilt and  $\pm 30^\circ$  for Roll
6. Data management improved to prevent the loss of profile settings
7. Overcurrent protection improved. First warning after 20sec and second warning after 60sec with switching off motors.
8. True Tilt, Roll and Home the default Ramp is changed from 50% to 10%.
9. The Analog Joystick input can be disabled.
10. The MGT-2 preset settings are improved.

11. Button assignment function improved to prevent double assignment.
12. Voltage warning is now working.
13. P, I and D algorithm improved to reduce vibrations.
14. Calculation of Euler angle improved to reduce roll axle correction at 90°.
15. Due to a bug in the algorithm, the **Limits** function has to be temporarily disabled.
16. Tilt range blockage has been removed

## 2 SUP Link / Technical Requirements

### How to get a Software Update Package

You can find the Software Update Package (SUP) in the TRINITY 2 download section on:

<https://www.arri.com/en/technical-service/firmware/software-updates-css/software-update-trinity-2>

Download the latest Software Update Package to your computer.

### Technical Requirements

The Software Update can be done securely with a Apple M1 and M2 or Windows 10 computer.



If this is the first update with a Windows computer, you also need to download a **USB driver** (MSR ST Virtual COM Port Driver V 1.4.0.).

You can find the USB driver on the ARRI CSS web page.

### USB Cables

USB-A to USB-C

OK



USB-C to USB-A adapter

OK

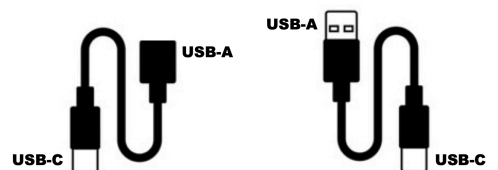

USB-A to USB-C

USB-C to USB-C

NOT OK

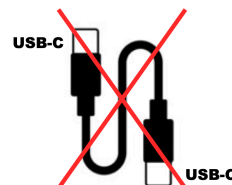

<b>ADVICE</b>	
A direct USB-C to USB-C connection is not compatible in this software update application.	

### 3 Update Preparations



No camera is required for the software update.

Park the fully prepared rig in the docking bracket.

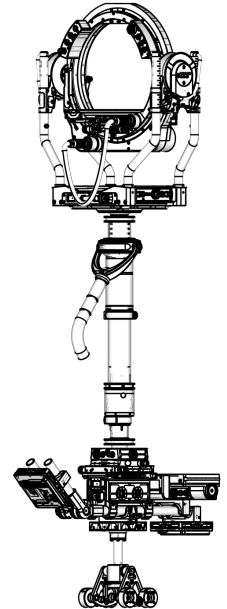

#### TRINITY 2 Head

1. Lock the **Tilt Lock!**
2. Switch **OFF** Main Power
3. Switch **OFF** TRINITY

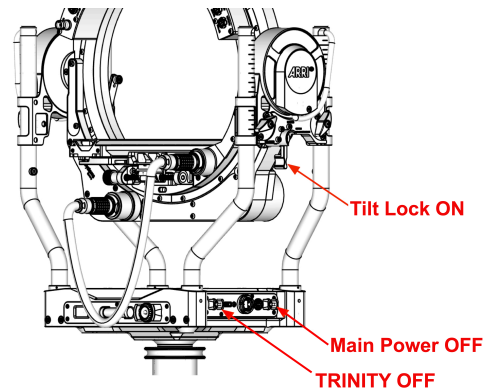

#### ADVICE

Make sure the TRINITY 2 head is **powered off** while the RCP-3 is being updated.

## Battery Hanger Preparations

4. Place minimum one battery.
5. Switch **ON** the Battery Hanger.

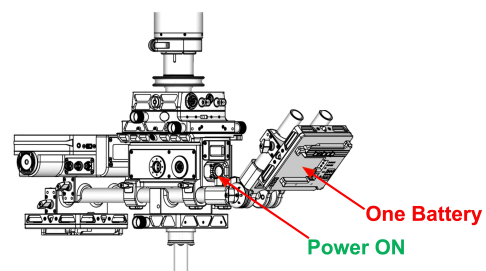

# 4 Update Instructions Apple Computers

## USB Cables

USB-A to USB-C

OK



USB-C to USB-A adapter

OK

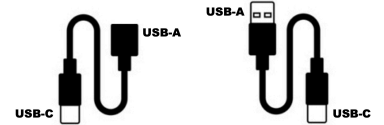

USB-A to USB-C

USB-C to USB-C

NOT OK

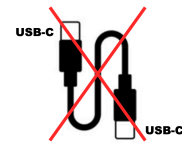

**ADVICE**

A direct USB-C to USB-C connection is not compatible in this software update application.

## RCP-3 Preparations

1. Switch **ON** the RCP-3.

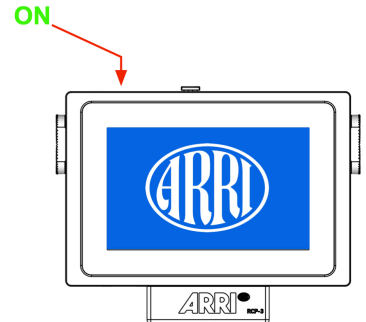

## Connect the USB Cable to the RCP

2. Connect the USB cable to the RCP-3.

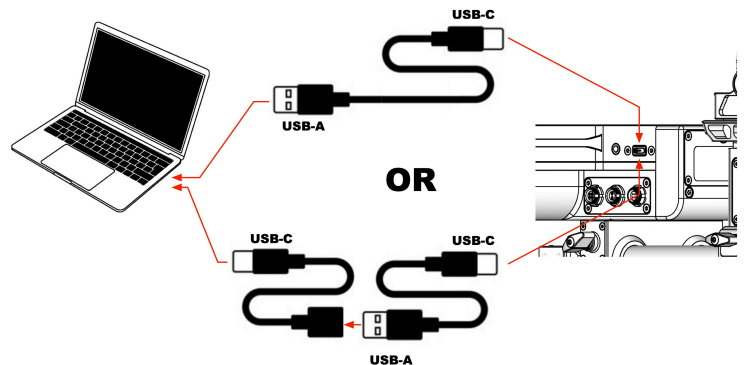

## Updater Programm

ADVICE



**It is imperative that the RCP-3 and TRINITY 2 head are always updated with the same current software!  
Different software versions prevent the use of the entire system.**

3. Double click the DNG file first.



TRINITY2\_update\_macos\_A00.01.40.dmg  
8,6 MB

4. Double click to start the updater program.



TRINITY2\_update\_macos\_A00.01.40.app

5. Click **Update** to start the upload process.



6. During the update, the progress is displayed on the screen.

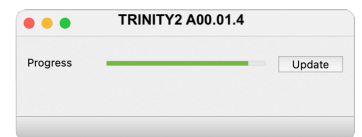

7. Once the software file has been uploaded into the RCP-3, the RCP-3 will **reboot** and a **gray screen** and the progress bar will appear.

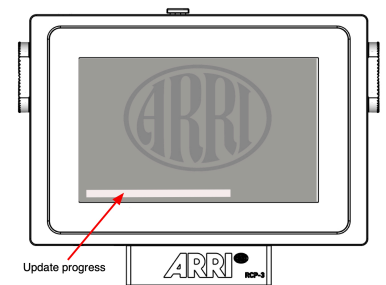

8. After the software update has been successfully completed, the RCP-3 restarts and the standard **blue** start screen is displayed.

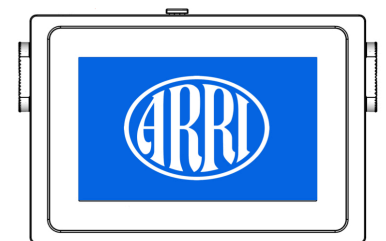

### Updating the TRINITY 2 Head

9. Switch **OFF** the RCP-3 first!

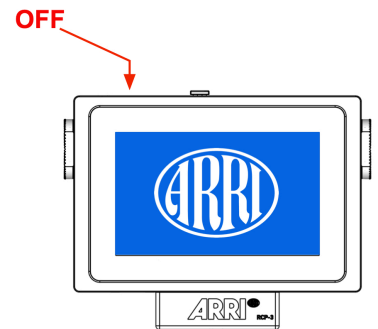

10. Switch **ON** the TRINITY 2 **Main Power**.

**ADVICE**

Keep the TRINITY switched **OFF!**

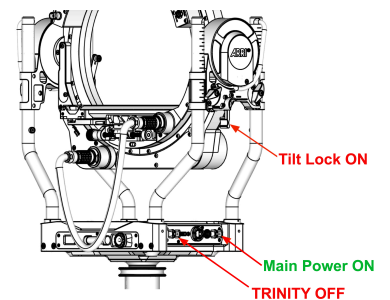

11. Connect the USB cable to the TRINITY 2 head.

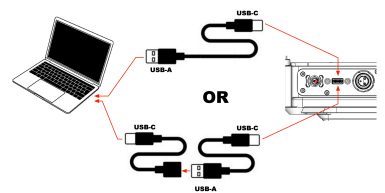

12. **Restart** the updater program.



13. Click **Update** to start the upload process.

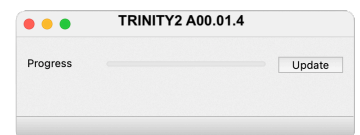

14. Once the software file has been uploaded into the TRINITY 2 head, the TRINITY 2 will reboot and the progress bar will appear in the display at the back.

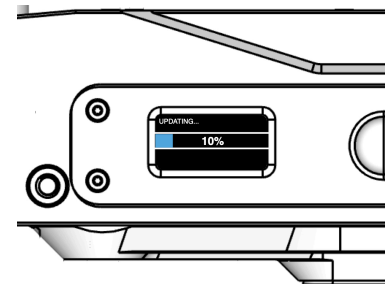

15. After the software update has been successfully completed, the TRINITY 2 head restarts and the standard start screen is displayed.

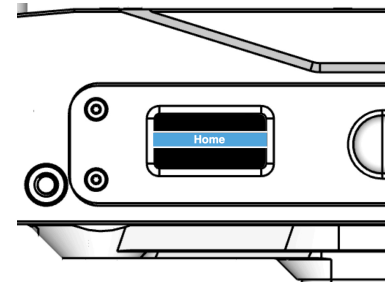

16. Update completed.

## Final Check

Now switch on the RCP-3 and go to:

- Main Menu
- Software Status

Make sure that the RCP-3 and the TRINITY 2 head got the same software status. (marked red)

	Remote	Kind	Head
Profile 1	RCP3xxxxxx	FoMa SN	TRINITY2xxxxxx
	K2.00xxxxx	ARRI SN	K2.00xxxxx
	ADD.01.A	CCPU	ADD.01.A
Profile 2	-	MCPU	V 0.200.2
	LCPU V 03.00.02	LCPU	LCPU V 03.00.02
	-	RCPU	-
Profile 3	V 0.8	Bootloader	V 0.8

# 5 Update Instructions Windows 10 / 11 Computers

## USB Cables

USB-A to USB-C

OK



USB-C to USB-A adapter

OK

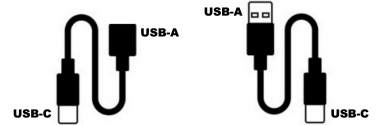

USB-A to USB-C

USB-C to USB-C

NOT OK

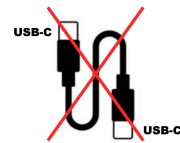

**ADVICE**

A direct USB-C to USB-C connection is not compatible in this software update application.

## RCP-3 Preparations

1. Switch **ON** the RCP-3.

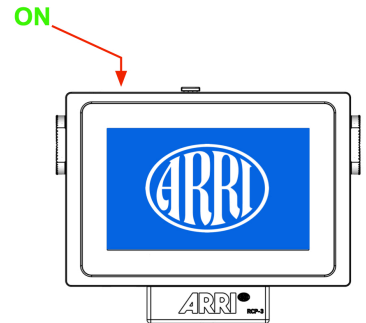

## Connect the USB Cable to the RCP

2. Connect the USB cable to the RCP-3.

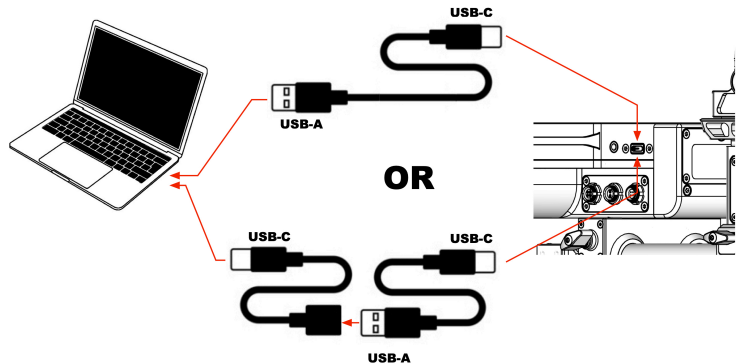

## Updater Programm

### ADVICE

**It is imperative that the RCP-3 and TRINITY 2 head are always updated with the same current software!**  
**Different software versions prevent the use of the entire system.**

3. Double click the ZIP file.
4. **NOTE**  
You must extract the file first



Windows\_updater-A001.01.4

5. Double click to start the updater program.



6. Click **Update** to start the upload process.

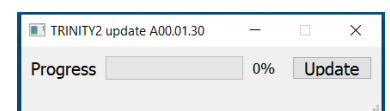

7. During the update, the progress and the used COM Port is displayed on the screen.

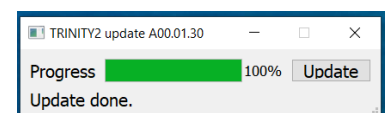
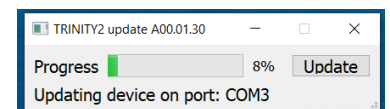

8. During the update, the progress and the used COM Port is displayed on the screen.
9. Once the software file has been uploaded into the RCP-3, the RCP-3 will **reboot** and a **gray screen** and the progress bar will appear.
10. After the software update has been successfully completed, the RCP-3 restarts and the standard **blue** start screen is displayed.

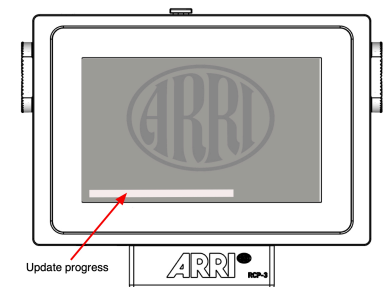
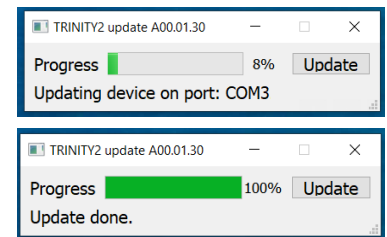

### Updating the TRINITY 2 Head

11. Switch **OFF** the RCP-3 first!

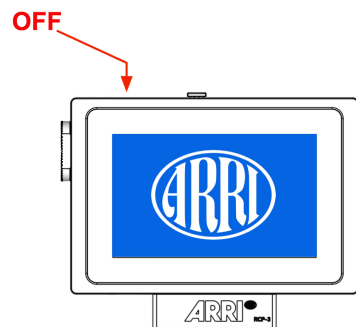

12. Switch **ON** the TRINITY 2 **Main Power**.

**ADVICE**

Keep the TRINITY switched **OFF!**

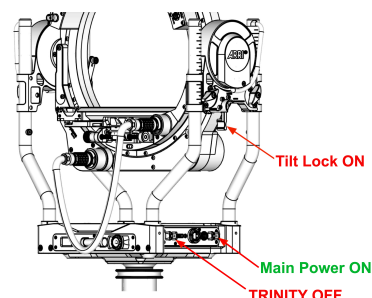

13. Connect the USB cable to the TRINITY 2 head.

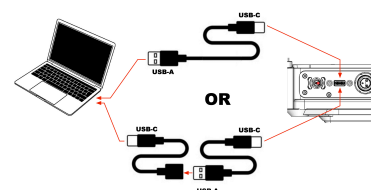

14. **Restart** the updater program.



15. Click **Update** to start the upload process.

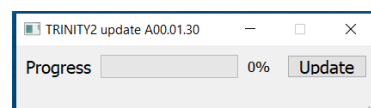

16. Once the software file has been uploaded into the TRINITY 2 head, the TRINITY 2 will reboot and the progress bar will appear in the display at the back.

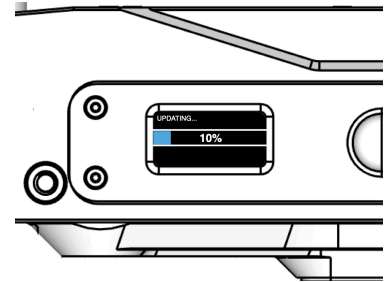

17. After the software update has been successfully completed, the TRINITY 2 head restarts and the standard start screen is displayed.

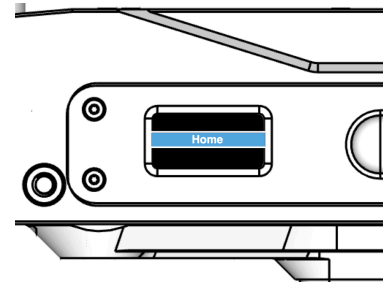

18. The update is complete.

### Final Check

Now switch on the RCP-3 and go to:

- Main Menu
- Software Status

Make sure that the RCP-3 and the TRINITY 2 head got the same software status. (marked red)

	Remote	Kind	Head
	RCP3#xxxxxx	FoMa SN	TRINITY2#xxxxxx
Profile 1	K2.00xxxxx	ARRI SN	K2.00xxxxx
	A00.01.4	CCPU	A00.01.4
Profile 2	-	MCPU	V 0.200.2
	LCPV V 03.00.02	LCPV	LCPV V 03.00.02
	-	RCPV	-
Profile 3	V 0.8	Bootloader	V 0.8

### Trouble Shooting

If this screen appears, it means that there is no connection to the RCP-3 / TRINITY 2 head.

- Check the USB-C cable connection.
- Try installing the USB driver manually.

#### NOTE

The driver can be found on the ARRI CSS website.

- Try the update again after restarting the PC and reconnecting the cables and components.

